

The Most Useful TV Schematics of 1954

RADIO - ELECTRONICS

JULY 1954

TELEVISION • SERVICING • HIGH FIDELITY

HUGO BERNBACK, Editor

In this Issue:

Color TV Tubes

Tape Recording
Amplifier

A. F. and R. F.
Signal
Generator

New Instruments
for
Better Servicing



35¢
U. S. AND
CANADA

VOLSCAN — Electronic Computer Controls Air Traffic

(See Page 4)



**customers enjoy
"PROFESSIONAL TREATMENT"**

■ television service as in any profession, whether it be barber or doctor, the client places great emphasis on the way you go about your business. Professional treatment of the customer creates confidence in your service and ultimately results in his satisfaction.

One way to insure this customer good will in TV service is to combine top-quality materials with your skilled, technical, workmanship. With dependable products, you can eliminate costly call-backs and build a reputation for quality service.

You can depend on Du Mont quality picture tubes to do more for your service.



Photo by Joe Clark, H. B. S. S. from Friends Magazine and Photography Magazine.

**Replacement Sales Cathode-ray Tube Division
ALLEN B. DU MONT LABORATORIES, INC.
750 Bloomfield Avenue, Clifton, N. J.**

**PIONEER IN BIG PICTURE TUBES • ORIGINATOR OF THE FAMOUS BENT-GUN AND SELFOCUS
LEADER IN HIGH-RESOLUTION • MAJOR SUPPLIER TO MOST FINE TELEVISION RECEIVER MANUFACTURERS**

* TRADE MARK

You Practice **SERVICING**

with Kits I Send You



Nothing takes the place of PRACTICAL EXPERIENCE. That's why NRI training is based on LEARNING BY DOING. You use parts I send to build many circuits common to Radio and Television. With my Servicing Course you build the modern Radio shown at left. You build a Multitester and use it to help make \$10, \$15 a week fixing sets in spare time while training. All equipment is yours to keep. Coupon below will bring book of important facts. It shows other equipment you build.

You Practice **BROADCASTING**

with Kits I Send You



As part of my Communications Course I send you parts to build low-power Broadcasting Transmitter at left. Use it to get practical experience. You put this station "on the air" . . . perform procedures demanded of broadcasting station operators. An FCC Commercial Operator's License can be your ticket to a bright future. My Communications Course trains you to get your license. Mail coupon. Book shows other equipment you build for practical experience.

I Will Train You at Home in Spare Time to be a **RADIO-TELEVISION** Technician



TELEVISION

Making Jobs, Prosperity

25 million homes have Television sets now. Thousands more sold every week. Trained men needed to make, install, service TV sets. About 200 television stations on the air. Hundreds more being built. Good job opportunities here for qualified technicians, operators, etc.

America's Fast Growing Industry Offers You Good Pay, Success



Training PLUS opportunity is the PERFECT COMBINATION for job security, advancement. When times are good, the trained man makes the BETTER PAY, gets PROMOTED. When jobs are scarce, the trained man enjoys GREATER SECURITY. NRI training can help assure you and your family more of the better things of life. Radio is bigger than ever with over 3,000 broadcasting stations and more than 115 MILLION sets in use, and Television is moving ahead fast.

N.R.I. Training Leads to Good Jobs Like These

I TRAINED THESE MEN



"Am transmitter-studio operator at KPAT. Most important day of my life was when I enrolled with NRI."—Elmer Frewadtt, Madison, S. Dakota.

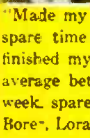

"Made my first \$100 from spare time work before I finished my course. Now I average better than \$10 a week, spare time."—Frank Bore, Lorain, Ohio.



"I've come a long way in Radio and Television since graduating. Have my own business on Main Street."—Joe Travers, Astury Park, New Jersey.



"I didn't know a thing about Radio. Now have a good job as Studio Engineer at KMMJ."—Bill Delzell, Central City, Nebraska.

BROADCASTING: Chief Technician, Chief Operator. Power Monitor, Recording Operator, Remote Control Operator. **SERVICING:** Home and Auto Radios, Television Receivers, FM Radios, P.A. Systems. **IN RADIO PLANTS:** Design Assistant, Technician, Tester, Serviceman, Service Manager. **SHIP AND HARBOR RADIO:** Chief Operator, Radio-Telephone Operator. **GOVERNMENT RADIO:** Operator in Army, Navy, Marine Corps, Forestry Service Dispatcher, Airways Radiotelegraph Operator. **AVIATION RADIO:** Transmitter Technician, Receiver Technician, Airport Transmitter Operator. **TELEVISION:** Pick-up Operator, Television Technician, Remote Control Operator.

Start Soon to Make \$10, \$15 a Week Extra Fixing Sets

My training is practical, complete; is backed by 40 years of success training men at home. My well-illustrated lessons give you basic principles you need and my skillfully developed kits of parts "bring to life" things you learn from the lessons. I start sending you special booklets that show you how to fix sets the day you enroll. Multitester you build with my parts helps you discover and correct set troubles, helps you make money fixing neighbors' sets in spare time while training. Many make \$10, \$15 a week extra this way.

Mail Coupon — Find Out What Radio-Television Offer You

Act now to get more of the good things of life. I send actual lesson to prove NRI home training is practical, thorough. My 64-page book "How to be a Success in Radio-Television" shows what my graduates are doing and earning. It gives important facts about your opportunities in Radio-

AVAILABLE to all qualified VETERANS UNDER G. I. BILLS

Television. Take NRI training for as little as \$5 a month. Many graduates make more than the total cost of my training in two weeks. Mail coupon now to: J. E. SMITH, President, Dept. 4GF, National Radio Institute, Washington 9, D. C. Our 43th year.

Good for Both—FREE

MR. J. E. SMITH, President, Dept. 4GF, National Radio Institute, Washington 9, D. C. Mail me Sample Lesson and 64-page Book, FREE (No salesman will call. Please write plainly.)

Name..... Age.....
 Address.....
 City..... Zone..... State.....

VETS write in date of discharge

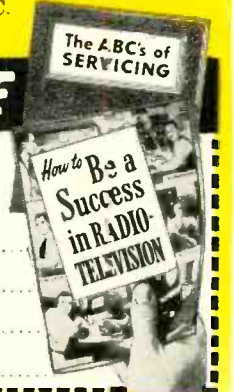

Mail Today—Tested Way to Better Pay

RADIO - ELECTRONICS

Formerly RADIO CRAFT • Incorporating SHORT WAVE CRAFT • TELEVISION NEWS • RADIO & TELEVISION*

Hugo Gernsback Editor and Publisher

M. Harvey Gernsback
Editorial Director
Fred Shunaman
Managing Editor
Robert F. Scott
W2PWG, Technical Editor
Jerome Kass
Associate Editor
I. Queen
Editorial Associate
Matthew Mandl
Television Consultant
Charles A. Phelps
Copy Editor
Angie Pascale
Editorial Production
Wm. Lyon McLaughlin
Tech. Illustration Director
Sol Ehrlich
Art Director

Lee Robinson
General Manager
John J. Lamson
Sales Manager
G. Aliquo
Circulation Manager
Adam J. Smith
Director, Newsstand Sales
Robert Fallath
Promotion Manager
Seymour Schwartz
Advertising Production



Member
Magazine Publishers
Association

ON THE COVER (See article on page 75)

The young lady on the cover, Miss Phyllis Barnes, is shown placing four gates on the PPI scope. The Antrac continuously reports to the computer, the exact positions of the four targets.

(Color original by Avery Slack)

CONTENTS

JULY 1954

Editorial (Page 29)					
Radioelectronics in 1980.....	by Hugo Gernsback	29			
Television (Pages 30-47)					
The Color CRT.....	by Leonard Lieberman	30			
Color TV Circuits, Part 2—Luminance and Bandpass Circuits.....	by Ken Kleidon and Phil Steinberg	33			
TV DX for July-September.....		35			
Television—it's a Cinch (Eleventh Conversation: heterodyning in a television receiver).....	by E. Aisberg	36			
TV Service Clinic.....	Conducted by Matthew Mandl	38			
Most Useful TV Circuits of 1954.....		40			
Test Instruments (Pages 48-55)					
Cross Dot Linearity Pattern Generator.....	by Dan Lerner and Winston Starks	48			
New Instruments for Better Servicing.....	by Robert F. Scott	51			
Compact Wide-Range Oscillator.....	by Richard Graham	54			
Audio—High Fidelity (Pages 56-74)					
A Versatile Tape Recording Amplifier.....	by George L. Augspurger	56			
For Golden Ears Only.....	by Monitor	59			
High Quality Audio, Part XI—Phase splitters: the center-tapped trans- former; the self balancing circuit; and the cathodyne (split-load) circuit.....	by Richard H. Dorf	62			
Servicing High-Fidelity Equipment.....	by Joseph Marshall	69			
Electronics (Pages 75-85)					
Volscan Speeds Up Air Traffic (cover story).....	by Angie Pascale	75			
Transistors from N to P.....	by George Fletcher Cooper	77			
A Transistorized Geiger Counter.....	by Nathan O. Sokal and Ira L. Resnick	82			
Selenium Regulators.....	by J. T. Cataldo	84			
Radio (Pages 86-95)					
Whistlers.....	by Jack Darr	86			
Card File.....	by H. Johnson	90			
Transistorized Commercial Killer.....	by Harold Reed	93			
New Design (Page 98)					
New Tubes and Transistors.....		98			
Departments					
The Radio Month	14	New Devices	104	Business	116
Correspondence	18	New Patents	108	Miscellany	120
Technotes	96	Question Box	110	People	121
With the Technician	100	Radio-Electronic Circuits	112	Electronic Liter- ature	123
		Try This One	114	Book Reviews	126

Vol. XXV, No. 7



MEMBER Audit Bureau of Circulations

Average Paid Circulation over 171,000

RADIO-ELECTRONICS, July 1954, Vol. XXV, No. 7. Published monthly at Mt. Morris, Illinois by Gernsback Publications, Inc. Application pending for transfer of Second Class entry from the Post Office at Philadelphia, Pa., to the Post Office at Mt. Morris, Ill. Copyright 1954 by Gernsback Publications, Inc. Text and Illustrations must not be reproduced without permission of copyright owners.

EXECUTIVE, EDITORIAL and ADVERTISING OFFICES: Gernsback Publications, Inc., 25 West Broadway, New York 7, N. Y. Telephone REctor 2-8630. Hugo Gernsback, President; M. Harvey Gernsback, Vice-President; G. Aliquo, Secretary.

SUBSCRIPTIONS: Address correspondence to Radio-Electronics, Subscription Dept., 404 N. Wesley Ave., Mt. Morris, Ill., or 25 West Broadway, New York 7, N. Y. When ordering a change please furnish an address stencil impression from a recent wrapper. Allow one month for change of address.

SUBSCRIPTION RATES: In U. S. and Canada, and in U. S. possessions, \$3.50 for one year; \$6.00 for two years; \$8.00 for three years; single copies 35c. All other foreign countries \$4.50 a year; \$8.00 for two years; \$11.00 for three years.

BRANCH ADVERTISING OFFICES: Chicago: 7522 North Sheridan Road, Tel. Rogers Park 4-8000. Los Angeles: Ralph W. Harker and Associates, 1127 Wilshire Blvd., Tel. Madison 6-1271. San Francisco: Ralph W. Harker and Associates, 582 Market St., Tel. GARfield 1-2481. FOREIGN AGENTS: Great Britain: Atlas Publishing and Distributing Co., Ltd., London E.C. 4. Australia: McGill's Agency, Melbourne. France: Brentano's, Paris 2e. Belgium: Agence et Messageries de la Presse, Brussels. Holland: Trilectron, Heemstede. Greece: International Book & News Agency, Athens. So. Africa: Central News Agency Ltd., Johannesburg. Capetown, Natal. Universal Book Agency, Johannesburg. Middle East: Steimatzky Middle East Agency, Jerusalem. India: Broadway News Centre, Dadar, Bombay #14. Pakistan: Paradise Book Stall, Karachi 3. POST-MASTER: If undeliverable send form 3578 to: RADIO-ELECTRONICS, 25 West Broadway, New York 7, N. Y. *Trademark registered U.S. Patent Office.

ADVANCE! Raise your earning power—learn RADIO-TELEVISION-ELECTRONICS by SHOP-METHOD HOME TRAINING

GOOD JOBS AWAIT THE TRAINED RADIO-TV TECHNICIAN

There is a place for *you* in the great Radio-Television-Electronics industry when you are trained as National Schools will train you at home!

Trained technicians are in growing demand at good pay—in manufacturing, broadcasting, television, communications, radar, research laboratories, home Radio-TV service, and other branches of the field. National Schools Master Shop-Method Home Training, with newly added lessons and equipment, trains you in your spare time, right in your own home, for these fascinating opportunities. **OUR METHOD IS PROVED BY THE SUCCESS OF NATIONAL SCHOOLS TRAINED MEN, ALL OVER THE WORLD, SINCE 1905.**

EARN WHILE YOU LEARN

Many National students pay for all or part of their training with spare time earnings. We'll show you how you can do the same! Early in your training, you receive "Spare-time Work" Lessons which will enable you to earn extra money servicing neighbors' and friends' Radio and Television receivers, appliances, etc.

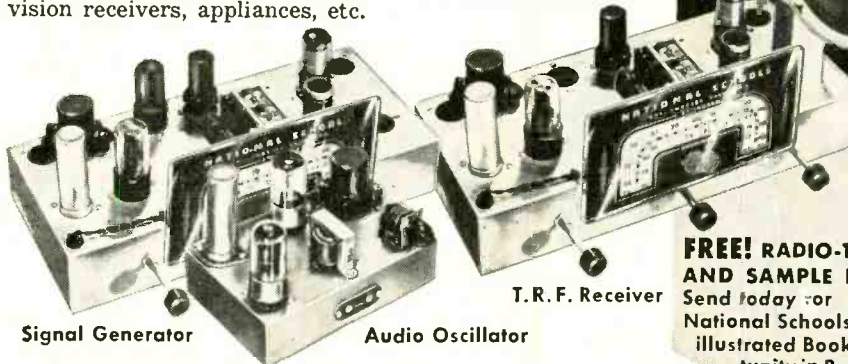

Signal Generator

Audio Oscillator

T.R.F. Receiver

National Schools Training is All-Embracing

National Schools prepares you for your choice of many job opportunities. Thousands of home, portable, and auto radios are being sold daily—more than ever before. Television is sweeping the country, too. Co-axial cables are now bringing Television to more cities, towns, and farms every day! National Schools' *complete* training program qualifies you in all fields. Read this partial list of opportunities for trained technicians:

Business of Your Own • Broadcasting
Radio Manufacturing, Sales, Service • Telecasting
Television Manufacturing, Sales, Service
Laboratories: Installation, Maintenance of Electronic Equipment
Electrolysis, Call Systems
Garages: Auto Radio Sales, Service
Sound Systems and Telephone Companies, Engineering Firms
Theatre Sound Systems, Police Radio
And scores of other good jobs in many related fields.

TELEVISION TRAINING

You get a complete series of up-to-the-minute lessons covering all phases of repairing, servicing and construction. The same lesson texts used by resident students in our modern and complete Television broadcast studios, laboratories and classrooms!



MASTER ALL PHASES!

Get Master Shop-Method Home Training from an Established Practical Resident School with its own Training Shops, Laboratories, Studios — almost 50 Years of Successful Experience in Training Ambitious Men.
We Bring National Schools To You!

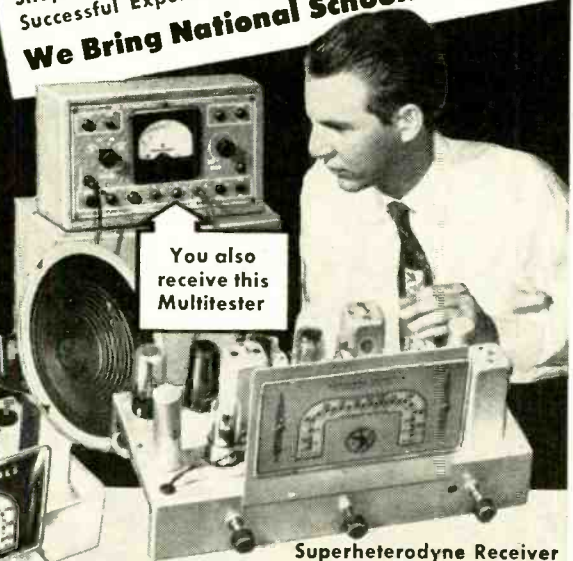

You also receive this Multitester

Superheterodyne Receiver

LEARN BY DOING

You receive and keep all the modern equipment shown above, including tubes and valuable, professional quality Multitester. *No extra charges.*

FREE! RADIO-TV BOOK AND SAMPLE LESSON!

Send today for National Schools' new, illustrated Book of Opportunity in Radio-Television-Electronics, and an actual Sample Lesson. No cost—no obligation. Use the coupon now—we'll answer by return airmail.

APPROVED FOR VETERANS AND NON-VETERANS
Check coupon below

Both Resident and Home Study Courses Offered!



NATIONAL SCHOOLS

LOS ANGELES 37, CALIFORNIA • ESTABLISHED 1905
IN CANADA: 811 W. HASTINGS STREET, VANCOUVER, B.C.

GET FACTS FASTEST! MAIL TO OFFICE NEAREST YOU!

(mail in envelope or paste on postal card)

NATIONAL SCHOOLS, Dept. RG-74

4000 S. Figueroa Street or 323 West Park Street
Los Angeles 37, Calif. or Chicago 7, Ill.

Send FREE Radio-TV Electronics book and FREE sample lesson. No obligation, no salesman will call.

NAME _____ BIRTHDAY _____ 19__

ADDRESS _____

CITY _____ ZONE _____ STATE _____

Check here if interested in Resident School Training at Los Angeles.
VETERANS: Give Date of Discharge

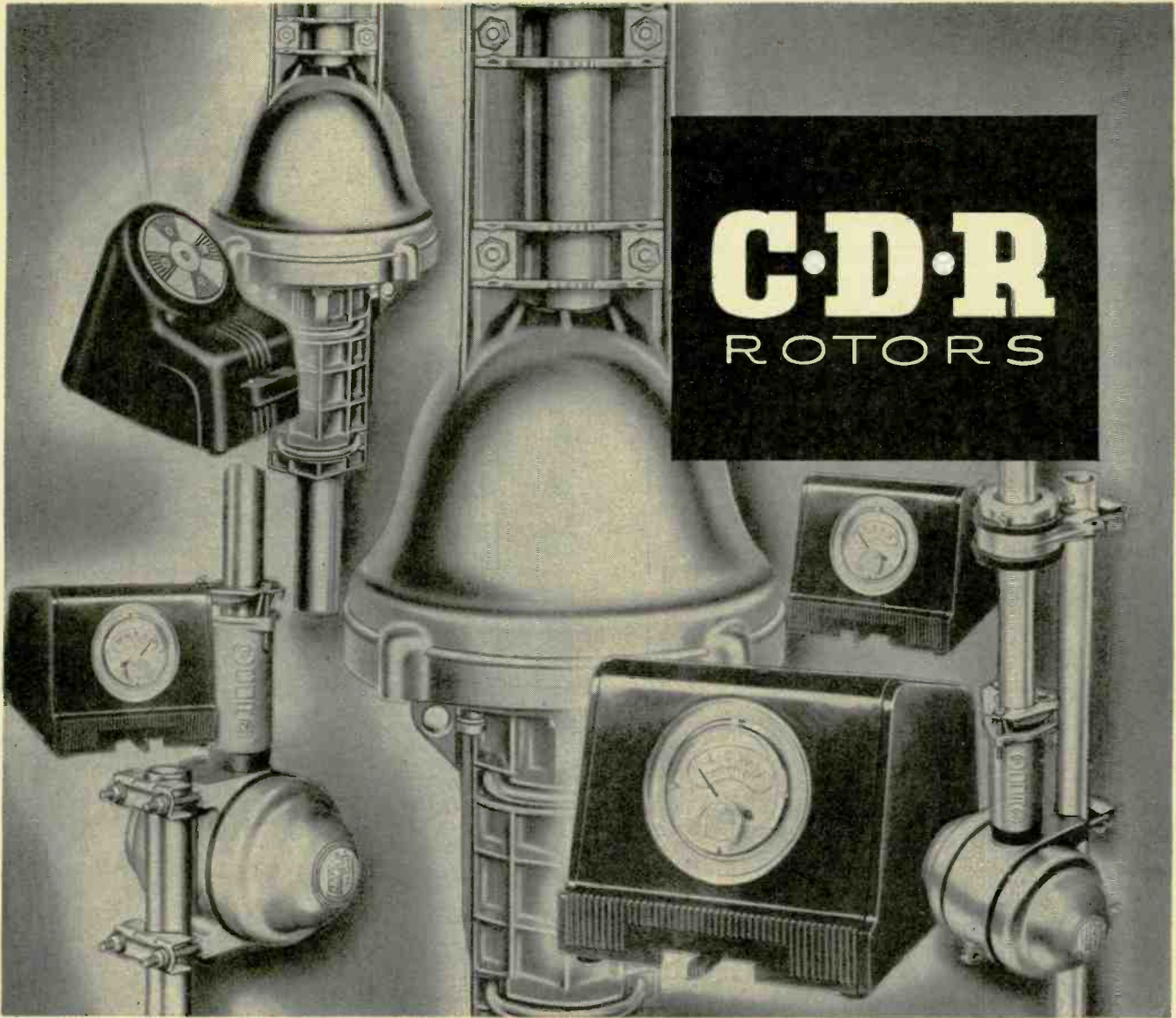

C·D·R ROTORS

no other rotor offers **SO MUCH**

a complete line

TR-2 the heavy duty rotor with compass control dial cabinet.

TR-4 the heavy duty rotor with meter dial cabinet.

TR-11 all purpose rotor with meter dial cabinet.

TR-12 all purpose rotor for large TV antenna arrays with meter dial cabinet.

widely promoted on TV
widely promoted to consumers on TV... ALL CDR ROTORS are PRE-SOLD for you through an extensive campaign to millions every week exploiting the advantages of the CDR.

completely merchandised
completely merchandised... the easiest to sell... in addition to the TV spot coverage... there are newspaper mats, window streamers, envelope enclosures... and an animated point of sale display... all the tools you need to sell the BEST SELLING ROTOR!

CORNELL-DUBILIER
SOUTH PLAINFIELD, N. J.



THE **RADIART** CORPORATION
CLEVELAND 13, OHIO

All Electronic Parts
YOURS TO KEEP!

Now!
Work over
300
practical projects
WITH THESE
PARTS...

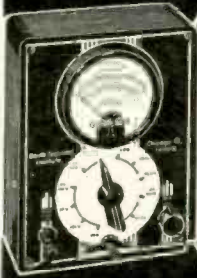

MULTIMETER

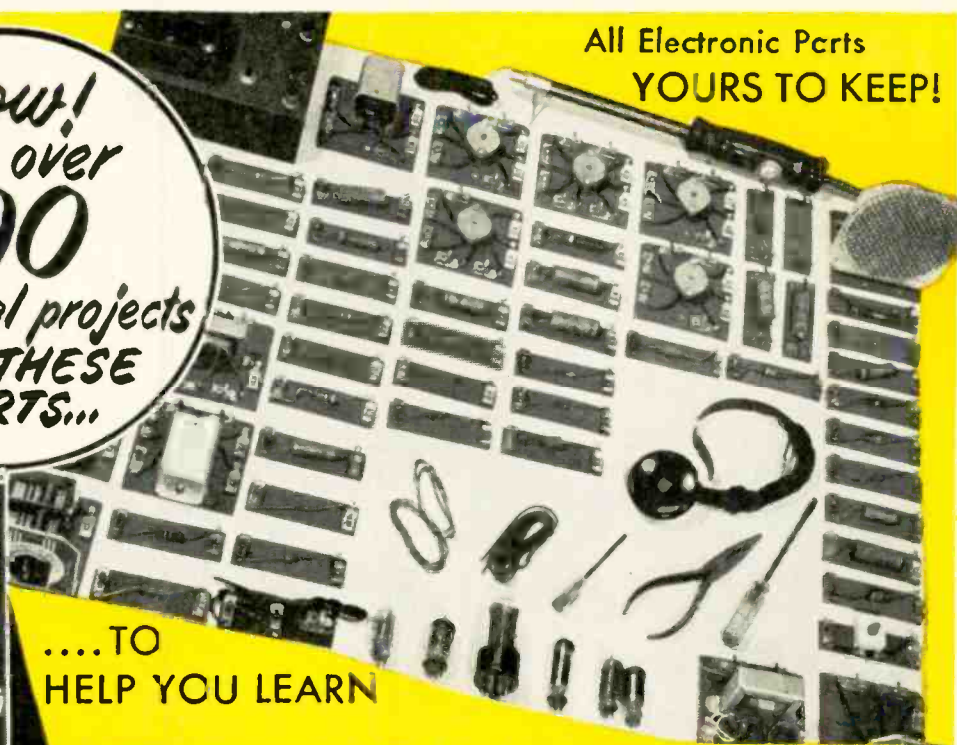

5 INCH
"SCOPE"

....TO
HELP YOU LEARN

TELEVISION

RADIO-ELECTRONICS Now... at home in spare time you can get BOTH the very training and subsequent Employment Service you need to help you start earning real money in America's thrilling, multi-billion dollar opportunity field of Television-Radio-Electronics. Now that television is coming to almost every community, here is a chance of a lifetime to prepare to cash in on one of television's great expansions.

D.T.I.'s amazingly practical home method enables you to set up your own HOME LABORATORY. You get many Electronic parts which you mount on individual bases with spring clip connectors. Tops for experimenting! Add or remove parts in a jiffy. No wasted hours of soldering and unsoldering for each project. You spend minimum time to get maximum knowledge of important circuits that really work. In fact, you get exactly the same type of basic training equipment used in our Chicago training laboratory—one of the nation's finest.

Build and KEEP This VALUABLE TEST EQUIPMENT

Your home laboratory projects also include building and keeping a versatile 5 inch Oscilloscope and precision Jewel Bearing Multi-Meter. These quality commercial test instruments help you EARN WHILE YOU LEARN and will prove mighty valuable, should you later decide to start your own full time TV-Radio service business. You also build and keep a quality 21 inch TV SET.

D.T.I. Provides EVERYTHING YOU NEED to master TELEVISION

In addition to your home laboratory and easy-to-read lessons, you even use HOME MOVIES—a wonderfully effective and exclusive D.T.I. training advantage. You watch hidden actions... see electrons on the march. Important fundamentals... become "movie clear," helping you learn faster... easier... better.

Full time Residential training in D.T.I.'s great Chicago laboratories also available. MAIL COUPON TODAY for all facts. (If subject to Military Service, you'll especially welcome the information we have for you.)

D.T.I.'s Training is available in Canada



HOME MOVIES



21 INCH

Build and keep this BIG DTI Engineered TV set—easily converted to U.H.F. (DTI offers another home training, but without the TV set.)

89 WAYS TO EARN MONEY

MAIL COUPON TODAY!



"ONE OF AMERICA'S FOREMOST TELEVISION TRAINING CENTERS"

DeVRY TECHNICAL INSTITUTE
AFFILIATED WITH
DeFOREST'S TRAINING, INC.
CHICAGO 41, ILLINOIS

DeVRY TECHNICAL INSTITUTE

4141 BELMONT AVE., CHICAGO 41, ILL. DEPT. RE-7-K

I would like your valuable information-packed publication showing how I can get started toward a good job or my own business in Television-Radio-Electronics.

Name _____ Age _____
Street _____ Apt. _____
City _____ Zone _____ State _____

GET OFF THE SPOT



AND
INTO
THE
SPOTLIGHT



WITH THE



BONDED ELECTRONIC TECHNICIAN PROGRAM

Once you gain the confidence of customers, you're on your way to increased volume and profits. The Raytheon *Bonded Electronic Technician* program is designed to help you do just that. The Raytheon Registered Bond Certificate, the Raytheon Creed Display Decal and Identification Cards, featuring your bonded status and the fine Raytheon "Code of Ethics", inspire customer confidence. And a recent survey proved that wherever Raytheon Bonded

Technicians took full advantage of their Bonded status — used it to inspire customer confidence — business improved by *at least ten per cent.*

Ask your Raytheon Tube Distributor if you can qualify for this important sales advantage. If you can, the bond is yours *at no cost to you* — it is *Raytheon's investment in your future.*



RAYTHEON MANUFACTURING COMPANY

Receiving Tube Division

Newton, Mass., Chicago, Ill., Atlanta, Ga., Los Angeles, Cal.

RAYTHEON MAKES ALL THESE:

RECEIVING AND PICTURE TUBES • RELIABLE-SUBMINIATURE AND MINIATURE TUBES • SEMICONDUCTOR DIODES AND TRANSISTORS • NUCLEONIC TUBES • MICROWAVE TUBES



Excellence in Electronics

Let me send you FREE
the entire story

Just fill out the coupon and mail it. I will send you, free of charge, a copy of "How to Pass FCC License Exams," plus a sample FCC-type Exam, and the amazing new booklet, "Money-Making FCC License Information."



CARL E. SMITH, E.E.
President

I can train you to pass your FCC License Exams in a minimum of time if you've had any practical radio experience—amateur, Army, Navy, radio servicing, or other. My time-proven plan can help put you, too, on the road to success.

How to Pass FCC COMMERCIAL Radio Operator License Exams

FREE

Tells where to apply and take FCC examinations, location of examining office, scope of knowledge required, approved way to prepare for FCC examinations, positive method of checking your knowledge before taking the examination.

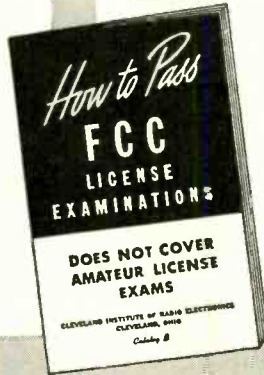

GET YOUR FCC TICKET IN A MINIMUM OF TIME

Get this Amazing Booklet FREE

TELLS HOW

HERE IS YOUR GUARANTEE

If you fail to pass your Commercial License exam after completing our course, we guarantee to continue your training without additional cost of any kind, until you successfully obtain your Commercial license, provided you first sit for this examination within 90 days after completing our course.

WE GUARANTEE

TO TRAIN AND COACH YOU AT HOME IN SPARE TIME UNTIL YOU GET

YOUR FCC LICENSE

If you have had any practical experience—Amateur, Army, Navy, radio repair, or experimenting

TELLS HOW

TV ENGINEERING INCLUDED IN OUR TRAINING & COACHING

Our Amazingly Effective JOB-FINDING SERVICE

Helps GIRE Students Get Better Jobs

Here are a few recent examples of Job-Finding results

GETS FIVE JOB-OFFERS FROM BROADCAST STATIONS
"Your 'Chief Engineer's Bulletin' is a grand way of obtaining employment for our graduates who have obtained their 1st class license. Since my name has been on the list I have received calls or letters from five stations in the southern states, and am now employed as Transmitting Engineer at WMMT."
Elmer Powell, Box 274, Sparta, Tenn.

GETS CIVIL SERVICE JOB
"I have obtained a position at Wright-Patterson Air Force Base, Dayton, Ohio, as Junior Electronic Equipment Repairman. The Employment Application you prepared for me had a lot to do with my landing this desirable position."
Charles E. Loomis, 4516 Genessee Ave., Dayton 6, Ohio.

OURS IS THE ONLY HOME STUDY COURSE WHICH SUPPLIES FCC-TYPE EXAMINATIONS WITH ALL LESSONS AND FINAL TESTS.

GETS AIRLINES JOB
"Due to your Job-Finding Service, I have been getting many offers from all over the country, and have taken a job with Capital Airlines in Chicago, as Radio Mechanic."
Harry Clare, 4537 S. Drexel Blvd., Chicago, Ill.

Your FCC ticket is required by most employers as proof of your technical ability.

TELLS HOW

Employers make

JOB OFFERS Like These to Our Graduates Every Month

Letter from nationally-known Airlines. "We would also appreciate if you would place the following additional advertisement in your bulletin—Wanted—Superintendent of Communications. Salary \$666.66 per month."

Letter from nationally-known airplane manufacturer. "We need men with electronic training or experience in radar maintenance to perform operational check-out of radar and other electronics systems . . . starting salary . . . amounting to \$29.33 per month."

These are just a few examples of the job offers that come to our office periodically. Some licensed radiomen filled each of these jobs . . . it might have been you!

HERE'S PROOF FCC LICENSES ARE OFTEN SECURED IN A FEW HOURS OF STUDY WITH OUR COACHING at HOME in SPARE TIME

Name and Address	License	Lessons
Lee Worthy 2210 1/2 Wilshire St., Bakersfield, Calif.	2nd Phone	16
Clifford E. Vogt Box 1016, Dania, Fla.	1st Phone	20
Francis X. Foerch 38 Beucler Pl., Bergenfield, N. J.	1st Phone	38
S/Sgt. Ben H. Davis 317 North Roosevelt, Lebanon, Ill.	1st Phone	28
Albert Schoell 110 West 11th St., Escondido, Calif.	2nd Phone	23

CLEVELAND INSTITUTE OF RADIO ELECTRONICS

CARL E. SMITH, E. E., Consulting Engineer, President
Desk RE-66 4900 Euclid Bldg., Cleveland 3, Ohio

Get All 3 FREE

MAIL COUPON NOW

CLEVELAND INSTITUTE OF RADIO ELECTRONICS

Desk RE-66

4900 Euclid Bldg., Cleveland 3, Ohio
(Address to Desk No. to avoid delay)

I want to know how I can get my FCC ticket in a minimum of time. Send me your FREE booklet, "How to Pass FCC License Examinations" (does not cover exams for Amateur License), as well as a Sample FCC-type exam and the amazing new booklet, "Money-Making FCC License Information." Tell me how I can get a TV Engineering Course without additional charge.

NAME
ADDRESS
CITY ZONE STATE

Paste on 2-cent post card or send air mail

Free! HEAVY-DUTY TOP-QUALITY PLIERS KIT

with 10 CBS-Hytron Pliers Kit Stamps

LIMITED OFFER

From July 1 through August 31 . . . Your CBS-Hytron distributor will give you 1 Pliers Kit Stamp with your purchase of 25 CBS-Hytron receiving tubes.



A
\$10.00
LIST VALUE

PICK UP THESE FINE IMPORTED TOOLS. Examine the beautiful finish of their drop-forged tool steel. Try their comfortable handle grips. Feel the precise balance . . . the powerful leverage. Go ahead! Cut some eight-penny nails. Like cutting cheese, wasn't it? And not a trace of a nick in the tough, carefully matched jaws.

You will be proud to own these husky, quality pliers. Tested . . . guaranteed . . . they can take it. And did you notice that two are unique? Nothing else just like them . . . they are "musts" for your tool kit. Yes sir, this free Pliers Kit (packed in an attractive, handy plastic case) is an offer you cannot afford to miss!



The **6 1/2-Inch Diagonals** are husky, box-joint, fully polished side cutters with precisely matched jaws. Size is right: Compact, but big enough . . . with comfortable, full-fashioned, full-polished handles . . . to do repeated, tough cutting jobs with ease.



The **8-Inch Long-Nose** is unique. Extra-long (2 3/4 inches), spring-tempered jaws combine with extra-long, knurled handles for powerful leverage. Hand-honed cutting knives. Beautifully chrome-plated.



The **6-Inch All-Purpose** is also unique. Combines: Flat and round nose. Jaws shaped for positive gripping. Two wire strippers. Two side cutters. Finish of handles is gun-metal; jaws are fully polished. This tool has everything.



Get This Pliers Kit Stamp Book . . .

and stamps from your CBS-Hytron distributor: One Pliers Kit Stamp for 25 CBS-Hytron receiving tubes. Each Stamp is imprinted with your CBS-Hytron distributor's code number. Redeem your Stamps with him.

This offer is valid only in areas where such offers are legal . . . and it is limited: July 1 through August 31. Don't miss it. Be sure to get your free CBS-Hytron Pliers Kit. See it at your CBS-Hytron distributor's . . . today!



CBS-HYTRON Main Office: Danvers, Mass.†

Manufacturers of Receiving Tubes Since 1921

A Division of Columbia Broadcasting System, Inc.

A member of the CBS family: CBS Radio • CBS Television • Columbia Records, Inc. • CBS Laboratories • CBS-Columbia • CBS International • and CBS-Hytron

RECEIVING • TRANSMITTING • SPECIAL-PURPOSE • TV PICTURE TUBES • CRYSTAL DIODES AND TRANSISTORS

Home Study Courses in TELEVISION SERVICING offered by RCA INSTITUTES



Study Television Servicing—from the very source of the latest, up-to-the-minute TV and Color TV developments. Train under the direction of men who are experts in this field. Take advantage of this opportunity to place yourself on the road to success in television. RCA Institutes, Inc. (A Service of Radio Corporation of America), thoroughly trains you in the "why" as well as the "how" of servicing television receivers.

FIRST HOME STUDY COURSE IN COLOR TV SERVICING

Now you can train yourself to take advantage of the big future in Color TV. RCA Institutes Home Study Course covers all phases of Color TV Servicing. It is a practical down-to-earth course in basic color theory as well as how-to-do-it servicing techniques.

This color television course was planned and developed through the combined efforts of instructors of RCA Institutes, engineers of RCA Laboratories, and training specialists of RCA Service Company. You get the benefit of years of RCA research and development in color television.

Because of its highly specialized nature, this course is offered only to those already experienced in radio-television servicing. Color TV Servicing will open the door to the big opportunity you've always hoped for. Find out how easy it is to cash in on Color TV. *Mail coupon today.*

SEND FOR FREE BOOKLET

Mail coupon in envelope or paste on postal card. Check course you are interested in. We will send you a booklet that gives you complete information. No salesman will call.



RCA INSTITUTES, INC.
A SERVICE OF RADIO CORPORATION of AMERICA
350 WEST FOURTH STREET, NEW YORK 14, N.Y.



HOME STUDY COURSE IN BLACK-AND-WHITE TV SERVICING

Thousands of men in the radio-electronics industry have successfully trained themselves as qualified specialists for a good job or a business of their own—servicing television receivers. You can do this too.

This RCA Institutes TV Servicing course gives you up-to-the-minute training and information on the very latest developments in black-and-white television.

As you study at home, in your spare time, you progress rapidly. Hundreds of pictures and diagrams, easy-to-understand lessons help you to quickly become a qualified TV serviceman.

There are ample opportunities in TV, for radio servicemen who have expert training. Mail coupon today. Start on the road to success in TV Servicing.

MAIL COUPON NOW

RCA INSTITUTES, INC.
Home Study Dept. RE-754
350 West Fourth Street, New York 14, N. Y.

Without obligation on my part, please send me copy of booklet on:

- Home Study Course in TELEVISION SERVICING.
 Home Study Course in COLOR TV SERVICING.

Name _____ (please print)

Address _____

City _____ Zone _____ State _____

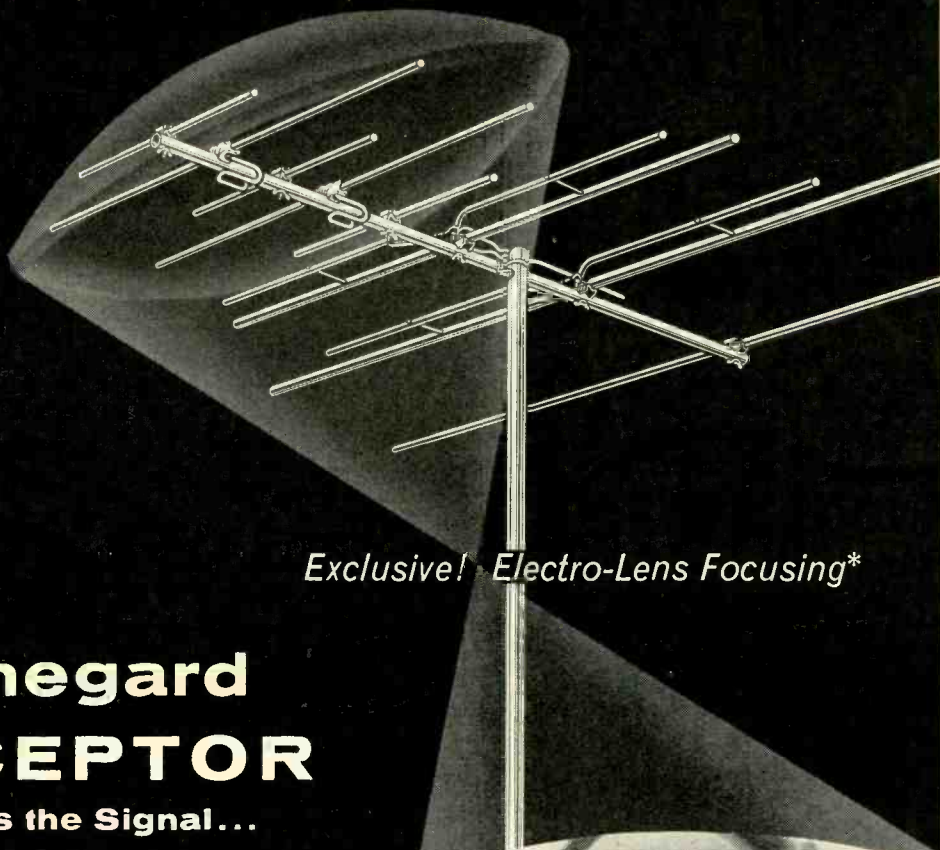

*Exclusive! Electro-Lens Focusing**

New Winegard INTERCEPTOR

**Grabs and Boosts the Signal...
Focuses It...like a Lens**

● Completely new in appearance. Completely new in electrical design. Sensational in results! The new INTERCEPTOR antenna now combines the famous Winegard Multi-Resonant Dipole with the most sensational electronic design of the decade... *Electro-Lens Focusing.** This exclusive Winegard feature literally grabs the signal out of the air and focuses it on the driven element the same as an ordinary lens focuses light. The result... a picture gloriously brilliant... sharp and clear. A picture up until now unobtainable!

● Never before has one antenna incorporated so many outstanding and exclusive features. The INTERCEPTOR gives highest possible gain and still maintains rejection from the back and sides that really shuts out co-channel interference. Its *Electro-Lens Focusing* makes it an ideal fringe area antenna without the bulk required by present fringe antennas. Small, light-weight and compact, the INTERCEPTOR's neat appearance will be appreciated by owners of the finest homes.

Attention: Servicemen! You will notice we show no charts trying to establish fabulous claims. We suggest you order a Winegard INTERCEPTOR today. If your regular jobber does not have it, please contact us. Test it for yourself. The INTERCEPTOR is its own best salesman!

- A Winegard Exclusive... *Electro-Lens Focusing*.
- All channels (2-13).
- Light, rigid, quick to assemble, easy to install.
- Low wind resistance.
- Designed for color reception.

For complete information on the Winegard INTERCEPTOR VHF antenna with exclusive *Electro-Lens Focusing*, send for Bulletin No. L-4.



WINEGARD COMPANY

3000 Scotten Boulevard, Burlington, Iowa

*Patent Pending

Get in on the TV boom . . .

starting today!

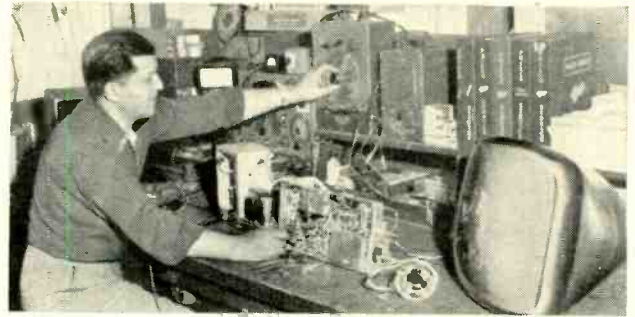

- Prepare now for the new Radio-TV-Electronics boom. Get in on VHF and UHF . . . aviation and mobile radio . . . color TV . . . binaural sound! The International Correspondence Schools can help you!

If you've ever thought about Radio or Television as a career . . . if you have the interest, but not the training . . . if you're waiting for a good time to start . . . NOW'S THE TIME!

No matter what your previous background, I.C.S. can help you. If Radio-TV servicing is your hobby, I.C.S. can make it your own profitable business. If you're interested in the new developments in Electronics, I.C.S. can give you the basic courses of training you need. If you have the job but want faster progress, I.C.S. can qualify you for promotions and pay raises.

I.C.S. training is *success-proved* training. Hundreds of I.C.S. graduates hold top jobs with top firms like R.C.A., G.E., DU-MONT, I.T.&T. Hundreds of others have high ratings in military and civil service. Still others have successful businesses of their own.

With I.C.S., you get the rock-bottom basics and theory as well as the all-important bench practice and experimentation. You learn in your spare time—no interference with business or social life. You set your own pace—progress as rapidly as you wish.

Free career guidance: Send today for the two free success books, the 36-page "How to Succeed" and the informative catalog on the course you check below. No obligation. Just mark and mail the coupon. With so much at stake, you owe it to yourself to act—and act fast!

CHECK THESE SEVEN
FAMOUS I. C. S. COURSES
—ONE FOR YOU!

- PRACTICAL RADIO-TELEVISION ENGINEERING**—Foundation course for radio-television career. Basic principles plus advanced training. Radio, Sound, TV.
- TELEVISION TECHNICIAN**—To qualify you for high-level technical positions in television. Camera, studio, transmitter techniques. Manufacture, sale and installation of TV equipment.
- TELEVISION RECEIVER SERVICING**—Installation, servicing, conversion. Dealership. For the man who knows about radio and wants TV training.
- RADIO & TELEVISION SERVICING**—Designed to start you repairing, installing and servicing radio and television receivers soon after starting the course.
- RADIO & TELEVISION SERVICING WITH TRAINING EQUIPMENT**—Same as above but with addition of high-grade radio servicing equipment and tools.
- RADIO OPERATING COURSE**—Special course to help you pass the Government examination for operator's licenses. Code, TV, FM, Radio regulations.
- INDUSTRIAL ELECTRONICS**—Broad, solid background course devoted to the electron tube and to its many applications.

I.C.S., Scranton 9, Penna.

INTERNATIONAL CORRESPONDENCE SCHOOLS



BOX 2887-L, SCRANTON 9, PENNA.

(Partial list of 277 courses)

Without cost or obligation, send me "HOW TO SUCCEED" and the opportunity booklet about the field BEFORE which I have marked X:

- | | | | | |
|---|--|--|--|---|
| <p>ARCHITECTURE and BUILDING CONSTRUCTION</p> <ul style="list-style-type: none"> <input type="checkbox"/> Air Conditioning—Refrig. <input type="checkbox"/> Architecture <input type="checkbox"/> Building Contractor <input type="checkbox"/> Building Maintenance <input type="checkbox"/> Carpenter and Mill Work <input type="checkbox"/> Estimating <input type="checkbox"/> Heating <input type="checkbox"/> Painting Contractor <input type="checkbox"/> Plumbing <input type="checkbox"/> Reading Arch. Blueprints <input type="checkbox"/> Steamfitting <p>ART</p> <ul style="list-style-type: none"> <input type="checkbox"/> Cartooning <input type="checkbox"/> Commercial Art <input type="checkbox"/> Fashion Illustrating <input type="checkbox"/> Magazine Illustrating <input type="checkbox"/> Show Card and Sign Lettering <input type="checkbox"/> Sketching and Painting <p>AUTOMOTIVE</p> <ul style="list-style-type: none"> <input type="checkbox"/> Auto Body Rebuilding <input type="checkbox"/> Auto Elec. Technician <input type="checkbox"/> Auto-Engine Tune Up <input type="checkbox"/> Automobile Mechanic | <p>AVIATION</p> <ul style="list-style-type: none"> <input type="checkbox"/> Aeronautical Engineering Jr. <input type="checkbox"/> Aircraft & Engine Mechanic <p>BUSINESS</p> <ul style="list-style-type: none"> <input type="checkbox"/> Advertising <input type="checkbox"/> Bookkeeping and Accounting <input type="checkbox"/> Business Administration <input type="checkbox"/> Business Correspondence <input type="checkbox"/> Certified Public Accounting <input type="checkbox"/> Creative Salesmanship <input type="checkbox"/> Federal Tax <input type="checkbox"/> Letter-writing Improvement <input type="checkbox"/> Managing Small Business <input type="checkbox"/> Office Management <input type="checkbox"/> Retail Business Management <input type="checkbox"/> Sales Management <input type="checkbox"/> Stenographic-Secretarial <input type="checkbox"/> Traffic Management <p>CHEMISTRY</p> <ul style="list-style-type: none"> <input type="checkbox"/> Analytical Chemistry <input type="checkbox"/> Chemical Engineering <input type="checkbox"/> Chem. Lab. Technician <input type="checkbox"/> General Chemistry <input type="checkbox"/> Natural Gas Prod. & Trans. <input type="checkbox"/> Petroleum Engineering <input type="checkbox"/> Plastics <input type="checkbox"/> Pulp and Paper Making | <p>CIVIL, STRUCTURAL ENGINEERING</p> <ul style="list-style-type: none"> <input type="checkbox"/> Civil Engineering <input type="checkbox"/> Construction Engineering <input type="checkbox"/> Highway Engineering <input type="checkbox"/> Reading Struct. Blueprints <input type="checkbox"/> Sanitary Engineering <input type="checkbox"/> Structural Engineering <input type="checkbox"/> Surveying and Mapping <p>DRAFTING</p> <ul style="list-style-type: none"> <input type="checkbox"/> Aircraft Drafting <input type="checkbox"/> Architectural Drafting <input type="checkbox"/> Electrical Drafting <input type="checkbox"/> Mechanical Drafting <input type="checkbox"/> Mine Surveying and Mapping <input type="checkbox"/> Ship Drafting <input type="checkbox"/> Structural Drafting <p>ELECTRICAL</p> <ul style="list-style-type: none"> <input type="checkbox"/> Electrical Engineering <input type="checkbox"/> Electrical Maintenance <input type="checkbox"/> Electrician <input type="checkbox"/> Contracting <input type="checkbox"/> Lineman <p>HIGH SCHOOL</p> <ul style="list-style-type: none"> <input type="checkbox"/> Commercial <input type="checkbox"/> Good English <input type="checkbox"/> High School Subjects <input type="checkbox"/> Mathematics | <p>LEADERSHIP</p> <ul style="list-style-type: none"> <input type="checkbox"/> Foremanship <input type="checkbox"/> Industrial Supervision <input type="checkbox"/> Leadership and Organization <input type="checkbox"/> Personnel-Labor Relations <p>MECHANICAL AND SHOP</p> <ul style="list-style-type: none"> <input type="checkbox"/> Gas-Electric Welding <input type="checkbox"/> Heat Treatment <input type="checkbox"/> Metallurgy <input type="checkbox"/> Industrial Engineering <input type="checkbox"/> Industrial Instrumentation <input type="checkbox"/> Industrial Supervision <input type="checkbox"/> Machine Design-Drafting <input type="checkbox"/> Machine Shop Inspection <input type="checkbox"/> Machine Shop Practice <input type="checkbox"/> Mechanical Engineering <input type="checkbox"/> Quality Control <input type="checkbox"/> Reading Shop Blueprints <input type="checkbox"/> Refrigeration <input type="checkbox"/> Sheet Metal Worker <input type="checkbox"/> Tool Design <input type="checkbox"/> Toolmaking <p>RADIO, TELEVISION</p> <ul style="list-style-type: none"> <input type="checkbox"/> Electronics <input type="checkbox"/> Practical Radio—TV Eng'ring <input type="checkbox"/> Radio and TV Servicing <input type="checkbox"/> Radio Operating <input type="checkbox"/> Television—Technician | <p>RAILROAD</p> <ul style="list-style-type: none"> <input type="checkbox"/> Air Brakes <input type="checkbox"/> Car Inspector <input type="checkbox"/> Diesel Locomotive <input type="checkbox"/> Locomotive Engineer <input type="checkbox"/> Section Foreman <p>STEAM AND DIESEL POWER</p> <ul style="list-style-type: none"> <input type="checkbox"/> Combustion Engineering <input type="checkbox"/> Diesel—Elec. <input type="checkbox"/> Diesel Eng'g <input type="checkbox"/> Electric Light and Power <input type="checkbox"/> Stationary Fireman <input type="checkbox"/> Stationary Steam Engineering <p>TEXTILE</p> <ul style="list-style-type: none"> <input type="checkbox"/> Carding and Spinning <input type="checkbox"/> Cotton, Rayon, Woolen Mfg. <input type="checkbox"/> Finishing and Dyeing <input type="checkbox"/> Loom Fixing <input type="checkbox"/> Textile Designing <input type="checkbox"/> Textile Eng'g <input type="checkbox"/> Throwing <input type="checkbox"/> Warping and Weaving <p>MISCELLANEOUS</p> <ul style="list-style-type: none"> <input type="checkbox"/> Domestic Refrigeration <input type="checkbox"/> Marine Engineering <input type="checkbox"/> Ocean Navigation <input type="checkbox"/> Shipfitting <input type="checkbox"/> Short Story Writing <input type="checkbox"/> Telephony |
|---|--|--|--|---|

Name _____ Age _____ Home Address _____

City _____ Zone _____ State _____ Working Hours _____ A.M. to P.M. _____

Occupation _____

Canadian residents send coupon to International Correspondence Schools, Canadian, Ltd., Montreal, Canada. . . . Special tuition rates to members of the U. S. Armed Forces.

Quality Features OF TUNG-SOL PICTURE TUBES

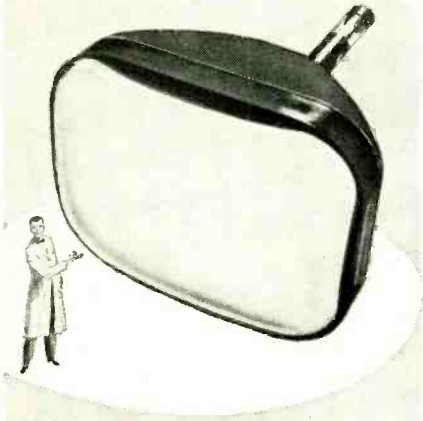

Gun made of best grade non-magnetic steel.

Glass bead type assembly is stronger both mechanically and electrically—gives greater protection against electrical leakage.

Rolled edges in gun minimize corona.

Custom built stem with greater spacing between leads assures minimum leakage.

Low-resistance of outside conductive coating minimizes radiation of horizontal oscillator sweep frequency.

Double cathode tab provides double protection against cathode circuit failure.

Selected screen composition resists burning (X pattern).

Rigid control of internal conductive coating provides utmost service reliability.

Designed for use with single or double field ion trap designs.

One-piece construction of parts assures better alignment.

Maximum dispersion of screen coating assures uniform screen distribution.

Tung-Sol makes All-Glass Sealed Beam Lamps, Miniature Lamps, Signal Flashers, Picture Tubes, Radio, TV and Special Purpose Electron Tubes and Semiconductor Products.

TUNG-SOL ELECTRIC INC., Newark 4, N. J. Sales Offices: Atlanta, Chicago, Columbus, Culver City (Los Angeles), Dallas, Denver, Detroit, Newark, Seattle.

TUNG-SOL®

RADIO AND TV TUBES



You Can Build A Reputation On Tung-Sol Quality

THE RADIO MONTH

ELECTRON MICROSCOPE twice as powerful as any now in use was displayed by RCA in ceremonies at United Nations where it was presented to the Karolinska Institute of Stockholm, Sweden. The new microscope will permit study of particles smaller than one 10-millionth of an inch in diameter. Photographs taken by an automatic camera contained in the instrument can be enlarged up to 200,000 times the size of the specimen.

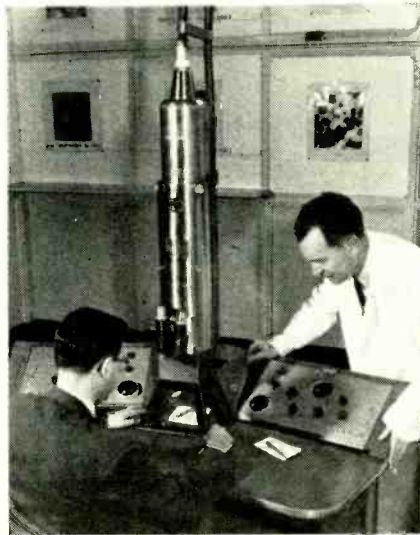

The electron microscope directs a concentrated beam of electrons through the specimen, which is placed in a small aperture in the column about halfway between the viewing screen and the electron gun at the top of the column. As the electrons pass down through the specimen they are affected in varying degrees according to the density and composition of the various parts of the specimen. When the beam emerges from the far side, it bears the pattern or image of the specimen, which is then magnified by magnetic lenses and projected on the viewing screen.

The instrument is the eighth RCA electron microscope in use in Sweden. Hundreds of the earlier types are in use throughout the world.

RETMA RADIATION LAB will be established as an independent certification unit for spurious radiation testing. Manufacturers will be able to send their TV and FM receivers to the laboratory for testing. Sets that pass the radiation tests will be permitted to carry a seal of approval.

ARRL AWARD has gone to A. Mack Seybold, RCA chemical engineer, for his important contributions to the elimination of television interference caused by amateur radio signals.

The award, presented annually by the American Radio Relay League, was based on an article dealing with sources and characteristics of unusual types of harmonic radiations from amateur radio signals, and outlining methods for their detection and elimination. It carries a \$300 cash prize.

COPPER-LINED ROOM believed to be the largest in the world of its type has been built by G-E and will soon be a part of their test and research facilities.

A total of 20,900 pounds of copper sheeting was used to completely cover the floor, walls, and ceiling of this room. The principal purpose of the copper is to provide a shield for keeping electromagnetic waves of external origin out of the room.

JACK POPPELE, veteran radio operator, engineer, and executive, has been appointed director of the Voice of America, taking office in May. Poppele is one of the best-known figures on the American radio scene. He is most closely associated in the minds of radiomen with pioneer broadcast station WOR. He directed the construction of WOR's first transmitter at Bamberger's department store in Newark, N.J., and became the station's first chief engineer.



Later he was made vice-president in charge of engineering of the Mutual Broadcasting System, which included WOR. He resigned that position in late 1952 to establish his own business as a television consultant and engineer, remaining, however, on the Board of Directors of Mutual.

His prebroadcasting experience goes back to 1910, when as a boy he constructed his own wireless station. Later he became a wireless operator at sea, at one time serving on the same ship with Allen B. Du Mont. During World War I he was an operator on an army transport.

TV TEETH has made its appearance as a physiological problem brought about by television. We have all heard about TV eyes—brought about by excessive television viewing. Now we are advised by the British Dental Association of a condition known as TV teeth.

An association report said that children have the habit of watching television with their heads held in their hands. When they get excited, they press harder and harder. This, the report says, may cause the teeth to go out of proper alignment.

big values

new releases

send for ALLIED'S Latest Free Supplement



Popular Knight Portable Radio Build-Your-Own Kit

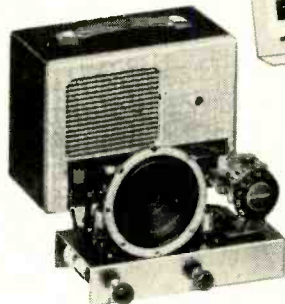

It's easy to build this powerful 3-way superhet portable for AC, DC or battery operation. Tunes 535-1650 kc broadcast band; has built-in antenna, printed-circuit audio, large PM speaker, handsome carrying case. Easy to assemble from illustrated manual. High quality kit includes all parts, tubes and case (less batteries). Shpg. wt., 6 lbs.
83 S 730. Only \$18.75
80 J 651. Battery Kit. Only \$2.74

Knight Super-Thin Portable Radio



An ideal battery-operated personal portable, hardly thicker than a book. Advanced superhet circuit features low-drain tubes for 100 hours of battery life. Includes built-in loopstick antenna, PM speaker, easy-tuning thumbwheel controls, automatic volume control. Develops surprising power and wonderful tone quality. Housed in beautiful red plastic case, 6 x 9 x 2 1/4" deep. With tubes (less batteries). Shpg. wt., 4 lbs.
54 K 717. Only \$17.95
80 J 651. Battery Kit. Only \$2.74

Sav-A-Battery Rejuvenator—Plays Portables from A.C.

Permits the operation of portable radios using single 1 1/2 v. "A" and single 67 1/2 v. "B" batteries from AC outlet. Fits into battery compartment of set. Also serves as "B" battery rejuvenator. Easy to install. 3 3/8 x 2 3/4 x 1 1/4". For 105-125 v., 50-60 cycles AC. Shpg. wt., 1 1/4 lbs.
80 P 190. Only \$5.85



Speedway Heavy-Duty Electric Drill



Exceptional value in a powerful, well-balanced drill. Has 1/4" gear-type chuck with key. Heavy-duty universal series-wound motor; self-aligning ball thrust bearings; trigger switch. No-load speed, 2400 rpm; full load, 1500 rpm. Capacity in steel, 1/2"; in hardwood, 1/2". Overall length, 9". U.L. approved. For 110-120 v., AC or DC. Shpg. wt., 4 1/2 lbs.
46 N 360. Only \$14.33

Ward Economy Auto Aerials



Low-cost top cowl auto antenna. Fits any model car; easily and quickly installed completely from outside of car. Has 3 sections; telescopes to 56". Of sturdy, durable tubing; chrome-plated; with "8-ball" mounting insulator. Complete with 36" high "Q" lead-in and coaxial-type connector. A value sensation; makes an ideal auto aerial replacement. Shpg. wt., 1 lb.
92 CX 000. Only \$2.32
92 CX 001. As above, but with 54" lead-in. Only \$2.54

Inter-Matic Time Switch

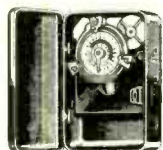

Ideal for control of room air conditioners, etc. SPST type; turns equipment on or off once in 24 hours; minimum time between settings, 1 hour. Manual operation won't interfere with settings. Handles 4000 watt load or 1 hp motor. Gray steel case with knockouts. 5 x 3 x 7 1/8". U.L. approved. For 105-125 v., 60 cycle A.C. Shpg. wt., 4 lbs.
78 B 322. Only \$7.12
78 B 323. Adapter Kit to make above unit portable. Consists of 6-ft. cord, plug, etc. Shpg. wt., 1 lb. Only 98c

PE-101-C Dynamotor Buy

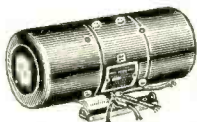

Brand-new government surplus unit for mobile Hams, etc., at sensational low cost. Ruggedly built. For cars with 6-volt or 12-volt electrical systems. With 12 v. DC input, delivers 610 v. DC at 150 ma and 325 v. DC at 125 ma. With 6 v. input, delivers 300 v. DC at 90 ma and 160 v. DC at 110 ma. Complete with conversion instructions. Dia., 4"; length after conversion, 10 1/2". Shpg. wt., 12 lbs.
80 P 195. Only \$4.95

New Fisher "50" Horn Speaker Enclosure



Deluxe enclosure for use with any 12" or 15" speaker system, single, 2-way, coaxial or tri-axial type. Compact, beautiful, flexible. Features: smooth response to below 30 cps; air loading of bass output reduces speaker distortion and increases power-handling capacity; substantially extends lower bass range; non-resonant design eliminates synthetic or "tuned" bass. Size: 37" h, 25" w, 20 1/8" d. 90 lbs.
81 DX 710. Dark Mahogany. Net \$129.50
81 DX 711. Korina Blonde. Net \$134.50

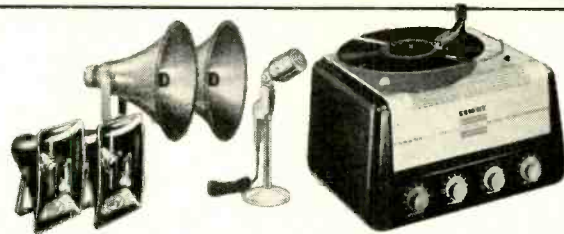

Knight 25-Watt 6V-110V P.A. System—A Top Value!

Here it is—a terrific value in a Universal P.A. System—for election campaigns, for any application requiring powerful indoor or outdoor amplification. Covers up to 85,000 square feet. Operates anywhere—from 110-130 v., 50-60 cycles AC or from any 6-volt auto storage battery. Features: 2 high impedance mike inputs; 1 phono input; optional record player; 25 watts *usable* output guaranteed; response 40-15,000 cps, ± 2 db.; 2 speaker outlets—wide selection of impedances; tone control; separate volume controls for mikes and phono; built-in 6-volt-110 volt power supply; amplifier guaranteed unconditionally for one full year; U.L. Approved. System includes: Knight 25-Watt Universal amplifier with tubes; AC and 6-volt cables; 2 University PH all-metal reflex trumpets complete with 25-watt driver units; E-V mike, table stand, 20-ft. cord and plug; 50-ft. speaker cable. (Less phono top.) Shpg. wt., 140 lbs.
93 SX 632. Complete System. Only \$182.50
WITH ELECTRO-VOICE PROJECTORS. As above, but with two E-V 848 compound diffraction projectors in place of University trumpets. Features extended frequency response. **93 SX 635. Only \$182.50**
3-SPEED PHONO TOP. Plays 78, 33 1/2 and 45 rpm records. Highest quality; with turnover crystal cartridge. **93 SX 640. Only \$17.45**

Best Buy Knight Push-Button Tape Recorder Top Recorder Value—NOW with Remote Control Provision



Latest model—acclaimed "best buy" by recording fans. Five push-buttons select all operating functions: fast forward, playback, stop, record and fast reverse. Now with provision for remote control. Takes up to 7" reels. Two-speed dual-track for wide range of recording times. At 3.75" per second, 7" reel records for 1 hour—and additional hour on second half of tape; at 7.5" per second, records 1/2 hour continuously, 1 hour overall. 7" reel rewinds in 3 minutes. Response: ± 3 db from 75-8500 cps at 7.5" speed; 80-6000 cps at 3.75" speed. Efficient erase system; "lock" prevents accidental erase. Features: two neon recording level indicators, 2-watt built-in amplifier; 5 x 7" oval speaker. Records from mike, radio, tuner or phono. Handsome 2-tone portable case, 14 x 12 x 9". Complete with mike, take-up reel and 600-ft. roll of tape. For 110-120 v., 60 cycles AC. U.L. Approved. Shpg. wt., 29 lbs. **96 RX 675. Only \$104.50**
REMOTE CONTROL. For remote starting and stopping of recorder. 18-ft. cable and plug. 2 x 3 x 3". Shpg. wt., 3 lbs. **96 R 636. Only \$6.64**

Special Value Knight Recording Tape

Top-quality, highly dependable 1/4" recording tape at exceptionally low cost. Plastic base, smoothly coated with red oxide. Manufactured to meet rigid specifications. Features very low noise level, uniform output, and excellent response characteristics. Type "A".
96 R 698. 600 feet. Net each, \$1.37. 5 or more, each \$1.24
96 R 699. 1200 feet. Net each, \$2.10. 5 or more, each \$1.89



New Centralab Compentrol—Improves Tone Quality

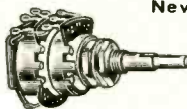

Dual shaft combination volume control and tone compensator—assures full range music, even at low volume levels. Accentuates bass and treble as volume is reduced. Level-set feature "customizes" control for individual room acoustics. For hi-fi amplifiers, radios, TV sets, etc. **30 M 436. Only \$4.41**

ALLIED RADIO CORP., Dept. 2-G-4
 100 N. Western Ave., Chicago 80, Ill.

FREE Supplement

Send FREE ALLIED Supplement No. 139.

Enter order for..... enclosed.

Name.....

Address.....

City..... Zone..... State.....

ALLIED RADIO

SERVICE TECHNICIANS: FOR YOUR SHOP!

THE COMPLETE PHOTOFACT SERVICE DATA LIBRARY

(world's best TV-Radio service data)

in this one handy
file cabinet

YOURS FOR ONLY

\$25 DOWN
NO CARRYING
CHARGES

1. If you now own some Sets of PHOTOFACT Folders, you can COMPLETE your present library this EASY-PAY-WAY
2. If you've never used PHOTOFACT, you've never realized your full earning power. Put this file cabinet with its 220 Sets of PHOTOFACT Folders to work... starting right NOW!

YES, ONLY \$25 DOWN PUTS
THE COMPLETE PHOTOFACT
LIBRARY IN YOUR SHOP...
COVERS OVER 17,000
TV, RADIO, RECORD
CHANGER, RECORDER
AND AMPLIFIER
MODELS

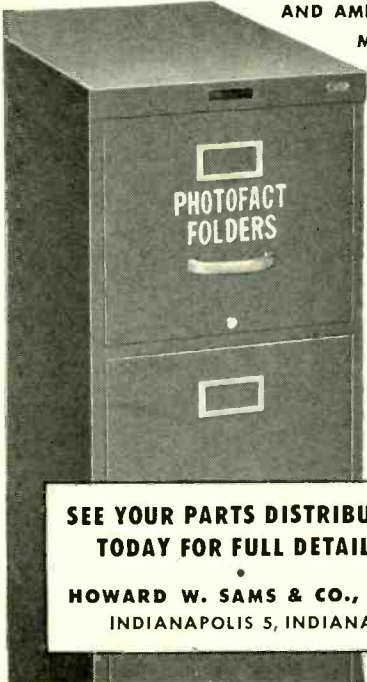

SEE YOUR PARTS DISTRIBUTOR
TODAY FOR FULL DETAILS

HOWARD W. SAMS & CO., INC.
INDIANAPOLIS 5, INDIANA

THE RADIO MONTH

EUROPEAN TELEVISION link consisting of eight nations went into operation June 6. On that date Belgium, Denmark, France, Germany, Holland, Italy, Switzerland and the United Kingdom began exchanging television programs, in a four-week experimental continental hookup.

by commercial and amateur operators.

COLOR MULTI-SCANNER for producing color television pictures directly from standard 16-mm color films has been demonstrated by Du Mont Laboratories. It was claimed that the pictures equal or excel live color television

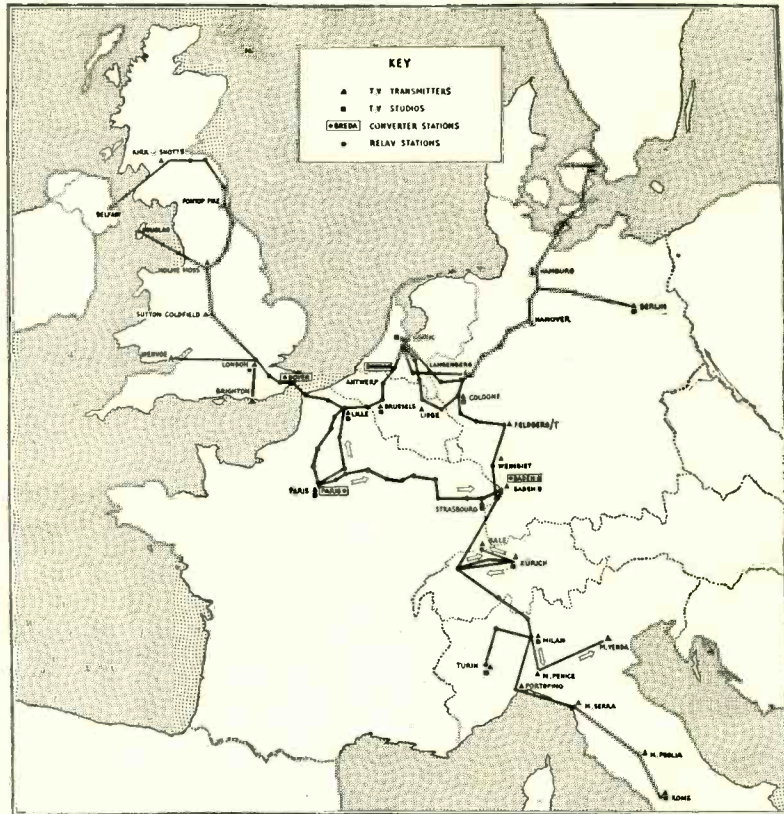

Last year BBC pictures of the Coronation were seen in France, Belgium, Holland and Germany. This year the remaining countries will be joined by microwave links.

The network (see map) covered about 4,000 miles with 44 TV transmitters and 80 radio relay stations.

FCC ANNIVERSARY was celebrated June 19. On that date 20 years ago the creative Communications Act of 1934 was signed. As stated in that statute, the Commission was established "For the purpose of regulating interstate and foreign commerce in communication by wire and radio..."

The act coordinated in a single agency regulatory functions previously controlled by the Federal Radio Commission, certain supervision of telephone and telegraph operations formerly vested in the ICC; jurisdiction over Government telegraph rates which had been under the Post Office Department, and some Department of State powers with respect to submarine cable licenses.

At the time of inception there were 51,000 authorized radio stations of all kinds, and fewer than 67,000 commercial and amateur radio operators. Today radio authorizations exceed 1,100,000, and more than 860,000 different grades of licenses and permits are held

broadcasting in technical quality. Using transparent slides, the Color Multi-Scanner also produced still color pictures of quality identical with the films.

Basically the unit is composed of three parts: the flying spot scanner; the color Cinecon pickup, resembling a compact movie projector; and a color slide changer pickup.

The pictures shown were from 16-mm Kodachrome originals, Kodachrome duplicate prints, Technicolor, Eastman, and Ansco color film. Since these films constitute approximately 85% of all color motion pictures now in 16-mm libraries, television stations will be able to give viewing audiences a wide choice of quality film presentations.

FOUR NEW TV STATIONS have gone on the air since our last report. These are:

WGAN-TV	Portland, Me.	13
WKNY-TV	Kingston, N. Y.	66
KTEN	Ada, Okla.	10
WSEE	Erie, Pa.	35

Seven stations have gone off the air: KDZA-TV, Pueblo, Colo., channel 3; WKLO-TV, Louisville, Ky., channel 21; KFAZ, Monroe, La., channel 43; WBKZ-TV, Battle Creek, Mich., channel 64; WTAC-TV, Flint, Mich., channel 16; KACY, Festus-St. Louis, Mo., channel 14; WFPG-TV, Atlantic City, N.J., channel 46. END



WANT MORE PAY? MORE SECURITY? A JOB WITH FUTURE UNLIMITED?

VETERANS! CIVILIANS! NO EXPERIENCE NECESSARY!

Go Into TELEVISION

I'll train you at home... in your spare time

for better-pay jobs in TV

L. C. Lane, B.S., M.A.
President: Radio-Television Training Association
Executive Director: Pierce School of Radio & Television

LEARN MORE

I give you ALL the practical training you need to qualify for the highest-paid technician jobs in TV.

RADIO-FM-TV TECHNICIAN TRAINING

No experience necessary! You learn by practicing with equipment I send you. It's easy! I give you the same successful guidance that has helped hundreds of men towards a TV career. Many started with only grammar school training.

FM-TV TECHNICIAN TRAINING

Saves you months if you have previous Armed Forces or civilian radio experience! Train at home. I give you kits, plus equipment to build **BIG SCREEN TV RECEIVER**, and **FREE FCC COACHING COURSE!** Everything **AT NO EXTRA COST!**

OPTIONAL: TWO WEEKS TRAINING IN NEW YORK CITY AT NO EXTRA COST!

You get two weeks, 50 hours, of intensive Laboratory work on modern electronic equipment at our associated school in New York City — Pierce School of Radio and Television. And I give you all this **AT NO EXTRA COST** whatsoever, after you finish your home study training in the Radio-FM-TV Technician course and FM-TV Technician Course.

FREE FCC COACHING COURSE!

Important for **BETTER PAY JOBS** requiring FCC License. You get this training **AT HOME** and **AT NO EXTRA COST!** Top TV jobs go to FCC licensed technicians.

NEW! PRACTICAL TV CAMERAMAN & STUDIO COURSE!

(For men with previous radio and TV training)

I train you at home for an exciting high pay job as the man behind the TV camera. Work with TV stars in TV studios or "on location" at remote pick-ups! A special one-week course of practical work on TV studio equipment at Pierce School of Radio & TV, our associate resident school in New York City, is offered upon your graduation.

VETERANS!

MY SCHOOLS FULLY APPROVED TO TRAIN VETERANS UNDER NEW G.I. BILL! If discharged after June 27, 1950 — CHECK COUPON! Also approved for RESIDENT TRAINING in New York City at Pierce School of Radio and Television... qualifies you for full subsistence allowance up to \$160 per month. Write for details.

RADIO-TELEVISION TRAINING ASSOCIATION

52 EAST 19th STREET, NEW YORK 3, N. Y.

Licensed by the State of New York • Approved by the VA

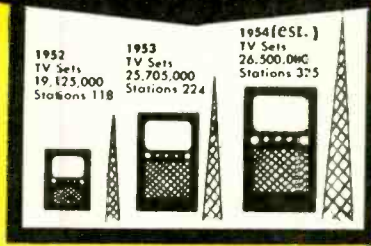

PROOF! TV NEEDS THOUSANDS OF TECHNICIANS!

TV is coming into practically every community. More than 2,000 new TV stations authorized in this country alone! Thousands of new studios being planned and built. All kinds of new equipment coming on the market. Millions of new TV-set owners will need servicing. It's the rich field of the future with money-making opportunities NOW... if you get in on the ground floor. There just won't be enough TV Technicians to go around. It's your chance of a lifetime for **GOOD EARNINGS** in a **TOP JOB** or **YOUR OWN BUSINESS!**

yours to build and keep!

EARN MORE

MORE MONEY AND A CAREER ARE WAITING FOR YOU HERE!

WARNING!

ALL VETERANS DISCHARGED BEFORE AUGUST 20, 1952 must be enrolled and IN TRAINING by August 20, 1954. Otherwise you lose your G.I. rights to a free education under NEW G.I. BILL! Don't put it off... time is short! RUSH COUPON BELOW. Tell your ex-G.I. friends!

GET MORE



Enough equipment to start your own home Laboratory! You learn by doing. I give you ALL the equipment. You build and keep a professional **GIANT SCREEN TV RECEIVER** complete with mammoth picture tube (takes any size up to 21 inch) ... also a Super-Het Radio Receiver, RF Signal Generator, Combination Voltmeter-Ammeter-Ohmmeter, C-W Telephone Transmitter, Public Address System, AC-DC Power Supply, and more! 15 full Kits! All tubes supplied, too!



Public Address System



C-W Telephone Transmitter



Combination Voltmeter-Ammeter-Ohmmeter

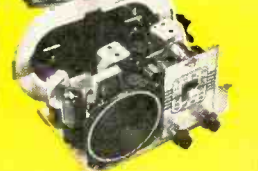

Super-Het Radio Receiver



RF Signal Generator

YOU GET ALL 4 FREE!

Just by mailing coupon. Try the Sample Lesson. Read how and where you can make big money in TV... easily!



MAIL THIS COUPON NOW! No Salesman Will Call!

Mr. Leonard C. Lane, President:
RADIO-TELEVISION TRAINING ASSOCIATION
52 East 19th Street, New York 3, N. Y. Dept. R-7B
Dear Mr. Lane: Mail me your **NEW FREE BOOK, FREE SAMPLE LESSON**, and **FREE** aids that will show me how I can make **BIG MONEY IN TELEVISION**. I understand I am under no obligation and no salesman will call.
(PLEASE PRINT PLAINLY)

NAME _____ AGE _____
ADDRESS _____
CITY _____ ZONE _____ STATE _____

I AM INTERESTED IN:
 Radio-FM-TV Technician Course
 FM-TV Technician Course
 TV Cameraman & Studio Course
VETERANS! Check here for Training under **NEW G.I. Bill**

Two Recognized Masters

Combined in perfect performance for the ultimate in

high-fidelity
reproduction



ASTATIC MODEL CAC-D-J CRYSTAL TURNOVER CARTRIDGE

THE MOST MASTERFUL performer among single needle, high fidelity crystal cartridges is Astatic's Model CAC-J, a result of collaboration between engineers of Astatic and Columbia Records Inc. How to project these same complete tonal values and absolute purity of reproduction into the design of a double needle, crystal turnover cartridge—without loss of perfection—seemed an insolvable engineering problem. But, pioneering in modern, high fidelity equipment proved as natural for Astatic engineers as their work in developing the first commercially produced crystal cartridges and microphones. The revolutionary new design of the Model CAC-D-J was the result. Combining two complete CAC-J Crystal Cartridge assemblies back to back, on a common plate, this unparalleled turnover unit eliminates interaction between needles and permits ideal output and response characteristics for each record type. Free of the limitations encountered in ordinary cartridge designs, the CAC-D-J has proved to be the most logical partner of the finest in high fidelity amplifiers, speakers and related equipment. When you want the very best, be sure to check this master of crystal cartridges.

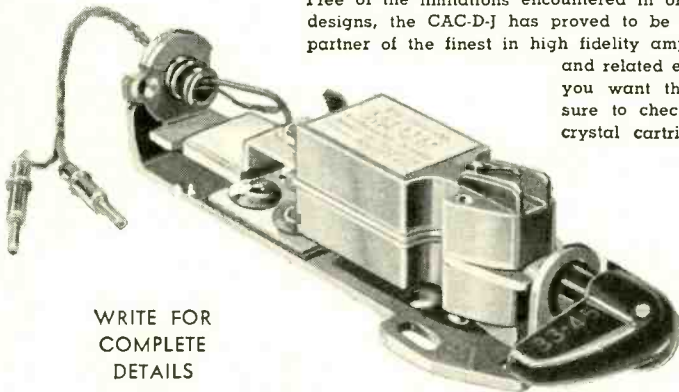
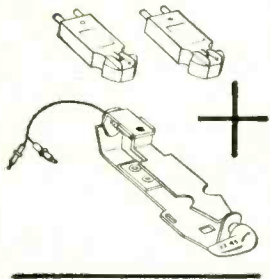

WRITE FOR
COMPLETE
DETAILS

KNOWN THE WORLD OVER
FOR HIGHEST QUALITY
AT LOWEST POSSIBLE COST

THE
Astatic
CORPORATION
CONNEAUT, OHIO
IN CANADA: CANADIAN ASTATIC LTD. TORONTO, ONTARIO

EXPORT
REPRESENTATIVE: 401 Broadway, New York, N. Y. Cable Address: ASTATIC, New York

CORRESPONDENCE

50-CYCLE POWER

Dear Editor:

In restudying my July, 1953, issue of RADIO-ELECTRONICS I ran into a comment you made with respect to the operation of radio, phonograph, and television equipment on 50-cycle power such as is used in Mexico City. Perhaps this information may be useful.

I was called to Mexico City last year to help iron out some problems in connection with the operation of a radio and television factory. I ran into the same problems mentioned by your questioner. The problem is not only one of difference in frequency. It is also a matter of voltage.

The power in the Federal District, which includes Mexico City and its suburbs, is not only 50 cycles, it is also 125 volts. The higher voltage, coupled with the lower frequency, plays havoc with electrical equipment designed to operate on 60 cycles. We found the only kind of phonograph, that would stand up under the beating it received in Mexico City was a Webster-Chicago model specially designed for that service. All other kinds we tried burned out after only a limited amount of use.

The 50-cycle power also created serious problems in television work. But the cause of the trouble was not so much the electrical effects as it was the magnetic effects. The 50-cycle magnetic fields created by the power transformer and other circuits affected the picture. In addition to the receivers built in that factory, experiments were conducted on numerous models built in the United States. All showed the same trouble.

It was found in most cases that the only satisfactory solution was to remove the power supply from the main chassis. By removing the 50-cycle magnetic fields from the vicinity of the picture tube, performance was very much improved.

LEE WILCOXON

Des Plaines, Ill.

IONIC OSCILLATOR

Dear Editor:

I would like to congratulate you for your interesting article, "The Ionic Oscillator" (December, 1953). I am a student of Technical Physics at the Vienna University of Technology, my field of special interest being gas discharge circuits. It may be of interest to you that in trying this experiment I found under certain conditions neon tubes will also oscillate, the range being about 150 to 300 kc. At present I am searching for the oscillation frequencies of the various continental gas tubes available.

JOSEPH BRAUNBECK

Vienna, Austria

DISTAFF DILEMMA

Dear Editor:

I was disgusted with the hen-pecked tone of Joseph Marshall's otherwise commendable article, Milady's Golden



**Better Contrast!
Longer Life!
Availability!**

SYLVANIA
*Aluminized
Picture Tubes*
**ARE PACKED
WITH PROFITS!**

Make old sets like new... have more satisfied customers!

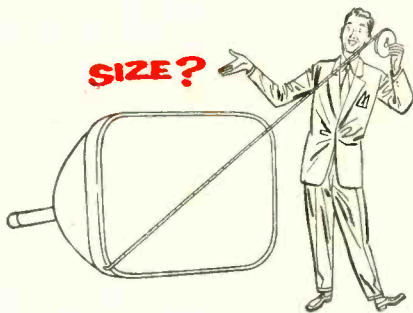

Interested in new sales records? You'll be heading in that direction when you replace old picture tubes with new Sylvania Aluminized Tubes.

Sylvania Aluminized Picture Tubes give terrific performance. They make old sets better and brighter than new by providing whiter whites—blacker blacks... a 6-times better picture contrast.

Sylvania Aluminized Picture Tubes are now available in most sizes for all popular TV sets. In other words, with Sylvania Aluminized Picture Tubes, you give your customers the best possible buy *and* the best possible service, including a full one-year warranty.

Remember, millions of set owners see and hear about Sylvania Picture Tubes on the nation-wide weekly television show "Beat The Clock." They know that they are famous for quality and dependability. For full details about aluminized tube replacement, write for Sylvania's "Aluminized Picture Tube Replacement Guide." Address: Dept. 4R-3807, Sylvania NOW!

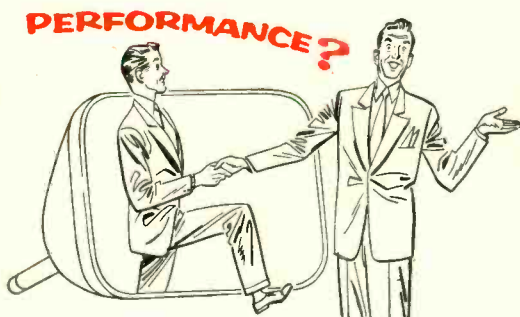
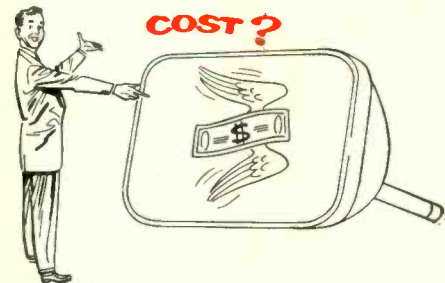

SYLVANIA

Sylvania Electric Products Inc.  1740 Broadway, New York 19, N. Y.

In Canada: Sylvania Electric (Canada) Ltd.
University Tower Building, St. Catherine Street, Montreal, P. Q.

LIGHTING • RADIO • ELECTRONICS • TELEVISION

3 SHURE CRYSTAL PICKUP CARTRIDGES replace the 192

cartridges you are most likely to encounter in your service work!



TECHNICAL DATA AND REPLACEMENT CHART IS ENCLOSED.

MODEL RK-54
Replacement Kit
List Price \$22.55

Lists 192 Crystal Cartridges manufactured by five leading cartridge manufacturers.

Lowest investment for broadest coverage! The RK-54 is beyond all doubt the most practical Replacement Kit on the market! Proof? Simply this—you get the broadest coverage at the lowest investment—only \$22.55 list! Think of it—3 Crystal Cartridges replace 192 of those specific Cartridges most likely to be in need of replacement! Two of the Cartridges consistently have been “best sellers” in the Shure line—as established by actual sales to Servicemen! The Cartridges are: Model W22AB, 3-Speed, 2-Needle Cartridge—Model W26B, All-Purpose, Single-Needle Cartridge—Model W78, 78 RPM, Dual-Volt, Dual-Weight Cartridge. Model W78 is the new, versatile Cartridge that replaces 149 other Cartridges. This Cartridge alone will become a sensation overnight! Order a Replacement Kit from your Distributor today—once you have worked with this practical kit you will find that these three Cartridges are dependable replacements—will make your service work faster, easier and more profitable!



TRANSPARENT PLASTIC BOX IS FREE!

This Handy Box is 5" long, 3½" wide, 1¼" deep.

SHURE

The Mark of Quality

Ear Amplifier, in your April issue.

Is it not enough that we have thoroughly catered to the caprices and illogical preferences of women in such fields as automobiles, architecture, and furnishings—to cite only a few—without also sacrificing the future of high-fidelity to these tin-eared tyrants?

The proven fact that the vast majority of audiophiles are men should serve to demonstrate that most women are intellectually, culturally, and scientifically unqualified to appreciate true high-fidelity, and consequently deserve no say in its acquisition or development.

VICTOR G. MAGRABI

Brooklyn, N. Y.

PEACE OF MIND

Dear Editor:

The other night, after coming home from work, I really enjoyed myself and I'd like to tell you about it. I babysat for a neighbor who had four children and one nonworking TV set, and I didn't see a single sign around the place indicating that her husband might have a hobby!

You see, my husband's hobby is hi-fi so we are amply equipped with three TV sets, umpteen radios, two record players, amplifiers, preamplifiers, pre-preamplifiers, and so on. He had been home with a cold and figured he could spend some time on his hobby.

Starting in a logical place, the bedroom, he set up the ironing board for table space, and opened up his parts box. In a few minutes the bed was covered with resistors, capacitors, coils, ohms, and everything else pertinent to the assembly of the whateveritis he was assembling.

He then expanded his operations to the living room where he unfolded a schematic the size of a bedsheet, together with about 60 issues of RADIO-ELECTRONICS and began searching for “that darn article.” He then ran to the back room and hauled out 10 paper bags of valuable used-only-once parts. They were placed on the kitchen table. The soldering iron was thoughtfully placed on the edge of the bathtub as a fire precaution.

It is in this stage of affairs that I arrived home from an 8-hour grind over a hot typewriter. I found that in addition to my husband's activities, the junior miss was wrapped around the telephone, the younger ones were blasting away à la Hopalong Cassidy, and the FM set was overriding the din with noise-free music.

So when my desperate neighbor announced her sitterless plight, I gladly went to her rescue. I returned home at midnight and went straight to bed except for a few minutes it took to bandage my toe when I accidentally kicked a power transformer.

You know, I mentioned that the neighbor's TV set wasn't working—I'll bet anything it was the 1B3 acting up. . . .

MRS. E. A. ARNESON

Rockville, Maryland



From America's Most complete WIRE LINE

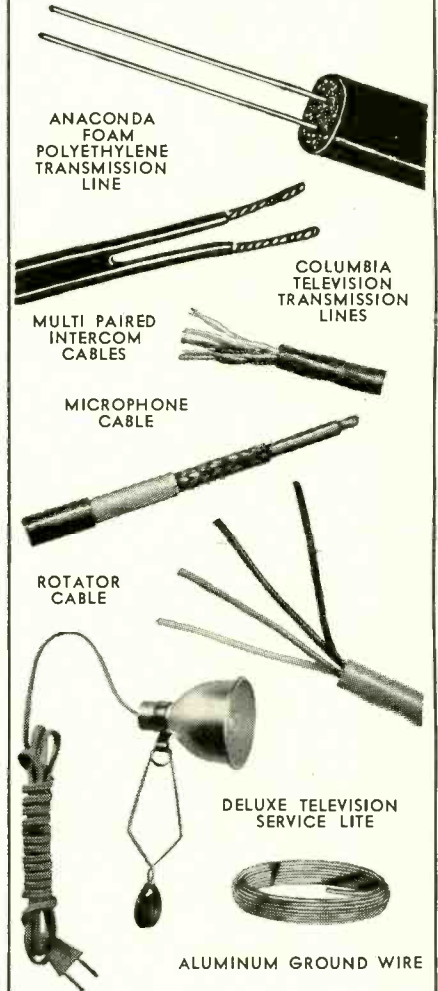

SPECIAL WIRE & CABLE TO YOUR SPECIFICATIONS SOLD THROUGH JOBBERS

ORDER TODAY!

New! Catalog #104—Just off the Press. Write for your copy TODAY.

Columbia WIRE & SUPPLY CO.
2850 Irving Park Road • Chicago 18, Ill.

Your
FREE copy
is ready!

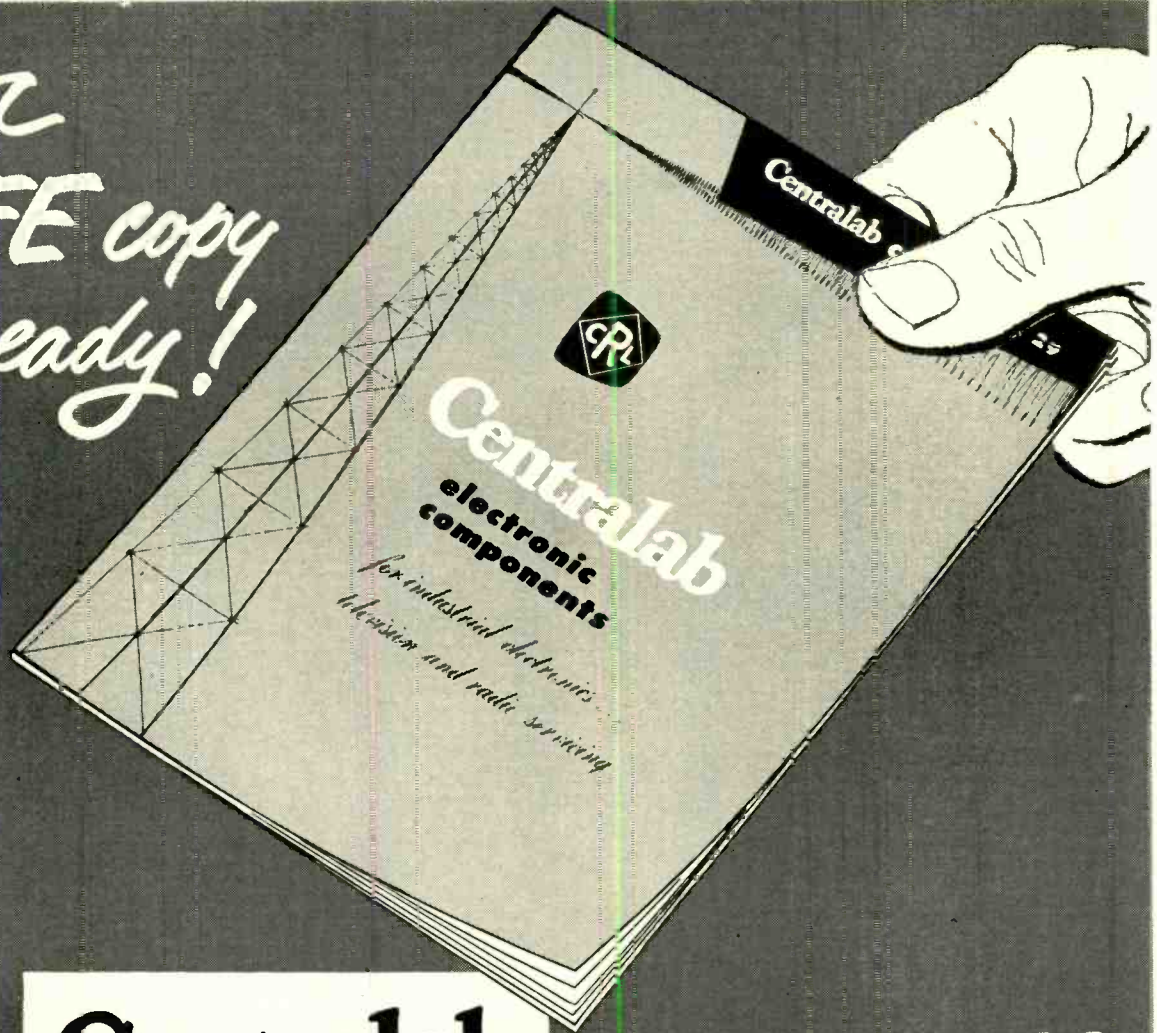

New Centralab Catalog No. 29

Keeps you up to date on Centralab's latest developments for faster, more profitable servicing

- New** values in Adashaft* Radiohms
- New** Adashaft shafts
- New** Snap-Tite Controls
- New** Fastatch* Dual Concentric Controls
- New** Senior Compentrol*
- New** miniature rotary phenolic switches
- New** Phenolic Switch Kit
- New** complete line of standard DD disc capacitors
- New** miniature disc capacitors
- New** 3000-VDCW and 6000-VDCW Hi-Vo-Disc* Capacitors
- New** arrangement of capacitor kits
- New** Precision Attachable Terminal Hi-Vo-Kaps®
- New** Negative 330 and Negative 1500 TC Tubular Capacitors
- New** easier-to-read listings on CRL Printed Electronic Circuits
- New** P. E. C.* Kits

*Trademark

Revised, 48-page edition of handy reference book on America's most complete line of volume controls, switches, capacitors, Printed Electronic Circuits*, steatite insulators

Centralab Catalog No. 29 pictures and describes hundreds of CRL components, with exact specifications and details.

Ask your Centralab distributor for your free copy. Or send the coupon to us today.

Centralab

Tear out coupon and mail today!

CENTRALAB, A Division of Globe-Union Inc.
922G E. Keefe Avenue, Milwaukee 1, Wisconsin

Send me free copy of Centralab Catalog No. 29.

Name.....

Company.....

Address.....

City..... Zone..... State.....

G-3254

ASTRON
capacitors for real...



GUTS

(*stamina as in Astron capacitors)



TWO basic conditions must be filled by capacitors to satisfy the need of service technicians:

Have they got GUTS? Yes—no one can look inside a capacitor and see how long it will stand up, or how much of a beating it will take over a long period of time. But you can put your trust in Astron for behind each Astron capacitor is the meticulous quality control that insures staying power. No call-back when you install an ASTRON!

Is there an ASTRON CAPACITOR for this job? Yes—there is an Astron capacitor built especially to fill the specific, exacting replacement requirements of any job you tackle.

See your local jobber today and ask for ASTRON!



Export Division: Rocke International Corp.
13 E. 40 St., New York, N. Y.

In Canada: Charles W. Pointon
6 Al. ina Ave., Toronto 10, Ontario

ASTRON

C O R P O R A T I O N

225 GRANT AVENUE, E. NEWARK, NEW JERSEY



**Train for a secure career
—not just another job!
Success ahead for trained men
only in**



Radio-TV-Electronics

**Stop Dreaming! Start Planning!
Start Doing! Start Your**

**CREI CAREER TRAINING
AT HOME TO INSURE
MORE INCOME!**



WHAT YOU DO NOW—today, tomorrow, next week—will decide your success in the electronics field. Every day counts because the trained technicians are the ones who get the “plums” when promotions are handed out. How can you be sure to step ahead of competition, to earn more money, to get the position that carries more responsibility—and the pay that goes with it? The answer is contained in a CREI booklet called “Your Future in the New World of Electronics.”

ERA OF COMMUNICATION

This is the era of Communication: aeronautical, marine, police and fire, industrial, land transportation. This is the era of defense orders and a manufacturing industry which last year alone sold billions of dollars worth of electronic equipment, which will top ten billion dollars (without military) this year. This is the era of electronic development, research, design, production, testing, inspection, manufacture, broadcasting, telecasting and servicing. This is the era of electronic careers—well-paid, interesting, and secure.



CREI resident instruction (day or night) is offered in Washington, D.C. New classes start once a month.

VETERANS: If you were discharged after June 27, 1950—check the coupon for full information about the new G. I. Bill of Rights.

WHO WILL GET AHEAD?



There's a vacancy coming up. It means a boost in pay, prestige and responsibility. Can you fill it? The answer is NO if you postpone your self-training. The answer is YES if you're trained in electronics.

CAPITOL RADIO ENGINEERING INSTITUTE

An Accredited Technical Institute

3224 16th St., N.W., Washington 10, D. C.



COLLEGE DEGREE NOT ESSENTIAL—You don't have to be a college graduate to benefit from CREI's famed courses. You *do* have to be willing to study at home. You can do it while holding down a full time job. Thousands have. No matter what your level of electronics experience, CREI has a course for you.

CREI's professional guidance is recognized all over the world. Since 1927 CREI has trained technicians; you find them in radio and television stations; you find them in electronics planning and manufacture; you find them everywhere and, generally, near the top. During World War II CREI trained men for the Armed Services. Leading firms choose CREI courses for group training in electronics (among them are United Air Lines, Canadian Broadcasting Corp., Trans-Canada Airlines, Bendix Products Division, RCA Victor Division and Canadian Marconi).

PRACTICAL COURSES

CREI's practical courses are prepared by recognized experts. You get up-to-date material. Your work is under the supervision of a regular staff instructor who knows and teaches what industry needs. Training is accomplished on your own time, during hours chosen by you.

KEY TO SUCCESS—As a graduate you'll find your CREI diploma the key to success in the entire field of electronics. At your service is the Placement Bureau which finds positions for advanced students and graduates. No short cuts are promised; no jobs are guaranteed—but requests for CREI-trained personnel far exceed current supply.

This can be your big year! Write today for complete details. Tuition is reasonable, terms are easy, information is free. Fill out the coupon and mail it at once.

MAIL COUPON FOR FREE BOOKLET

CAPITOL RADIO ENGINEERING INSTITUTE

Dept. 147-A, 3224 16th St., N.W., Washington 10, D. C.

Send booklet “Your Future in the New World of Electronics” and course outline.

CHECK FIELD OF GREATEST INTEREST

- TV, FM & Advanced AM Servicing
- Practical Television Engineering
- Broadcast Radio Engineering (AM, FM, TV)
- Practical Radio Engineering
- Aeronautical Radio Engineering

Name

Street

City Zone State

Check Residence School Veteran

NATION WIDE!

THE FIRST CHOICE OF SERVICEMEN

Here's the antenna beyond all comparisons — the antenna that gives you exactly what you want in packaging, ease of assembly, appearance, and above all, customer satisfaction through outstanding performance.

The Taco Trapper is the only high-gain, broad band antenna that retains the appearance, mechanical balance, and low wind resistance of the accepted medium-gain, streamlined yagi design.

Cat. No. 1880 Taco Trapper \$19.75 ea.
Cat. No. 1882 Stacking Kit 1.75 ea.
Cat. No. 1884 4-Stack Kit 5.90 ea.

COMPLETE DETAILS FROM YOUR DISTRIBUTOR...

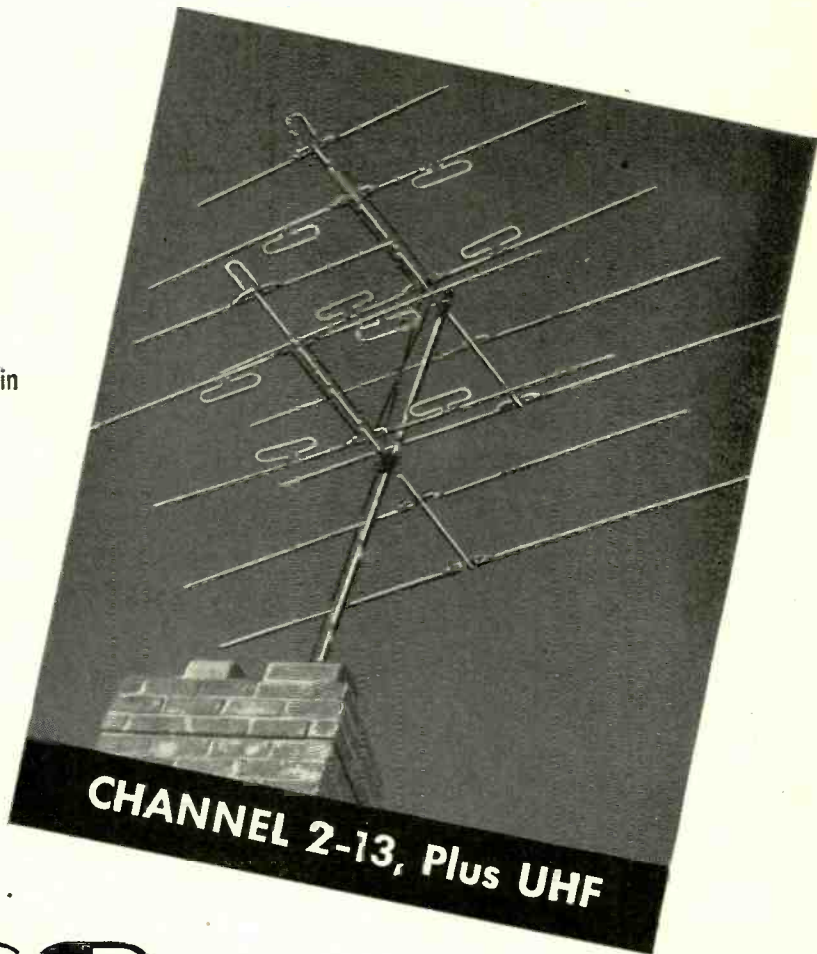

the TACO TRAPPER...



Packed two antennas per carton . . . No king-size cartons — fits in average auto!



Completely factory-assembled — no loose parts!

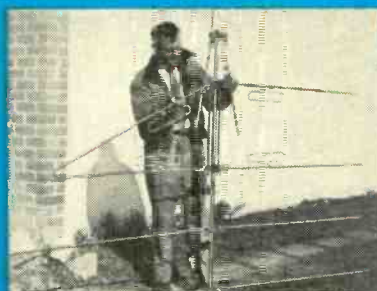

Opens as easily as an umbrella. Elements automatically lock in position!



Exclusive Taco design permanently locks elements — WITHOUT USE OF TOOLS.

TECHNICAL APPLIANCE CORPORATION • Sherburne, N. Y.

In Canada: Hackbusch Electronics, Ltd., Toronto 4, Ontario

Now—the RCA WR-86A

...a UHF Sweep Generator

for research,
production and
servicing for the price
of a service
instrument

only **\$275.00**
(Suggested
User Price)



CHECK THESE FEATURES

- **Wide frequency range**—continuous from 300 to 950 Mc.
- **Wide sweep range**—continuously adjustable up to 10% of indicated dial frequency for any frequency up to 750 Mc; up to 75 Mc for frequencies from 750 to 950 Mc.
- **Flat output**—maximum voltage amplitude variation 0.1 db/Mc over swept range.
- **High output voltage**—0.6 volt across 50 or 300 ohms.
- **Wide range attenuation**—continuously adjustable over a range of 60 db.
- **Electro-mechanical sweep** of rugged, time-tested design.
- **Phased blanking circuit** provides essential zero-reference line.
- **Phased horizontal deflection** voltage for oscilloscope.
- **50- and 300-ohm outputs**—balanced 300-ohm output provided by shielded, padded 50- to 300-ohm balun.

Specification

- **Power Supply:** 105-125 volts, 60 CPS.
- **Dimensions:** 13½" long, 9¾" high, 7½" deep.
- **Weight:** 14 lbs.
- **Finish:** Blue-grey hammeroid.

Now, for the first time, RCA offers a UHF Sweep Generator having the precision and stability of laboratory types, for the price of a service instrument. Because of advancements in engineering design, the new WR-86A UHF Sweep Generator is suitable for both production-line testing and for general service applications on color and black-and-white UHF receivers, converters, tuners, filters, antennas, transmission lines, and other equipment operating in the range from 300 to 950 Mc.

The sweep oscillator uses an RCA-6AF4 UHF triode in a specially designed circuit providing excellent sweep linearity and a maximum amplitude variation of 0.1 db/Mc combined with a large sweep width.

The oscillator compartment and its associated components are specially designed and sturdily constructed to assure maximum stability and

reliable performance over extended operating periods. Critical parts are silver plated, and the entire oscillator section is enclosed in a silver-plated compartment to minimize leakage.

A blanking circuit is included to provide a reference base line on an oscilloscope. Horizontal sweep for the 'scope can be obtained from front-panel terminals.

The RCA WR-86A comes completely equipped with 4-foot rf output cable, 50- to 300-ohm padded balun, and instruction book.

Get full details today from your RCA
Distributor or clip coupon and mail to:

RCA Commercial Engineering
Section G-39-W, Harrison, N. J.
Please send me information on the RCA WR-86A
UHF Sweep Generator.

Name _____
Address _____ Zone _____ State _____
City _____
My local RCA Distributor is _____



RADIO CORPORATION of AMERICA
TEST EQUIPMENT
HARRISON, N. J.

*The Bell Solar Battery.
A square yard of the small
silicon wafers turns sunshine
into 50 watts of electricity.
The battery's 6% efficiency
approaches that of gasoline and
steam engines and will be
increased. Theoretically the
battery will never wear out.
It is still in the early
experimental stage.*

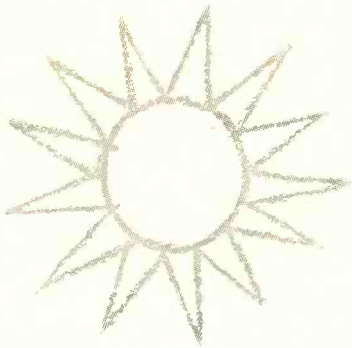
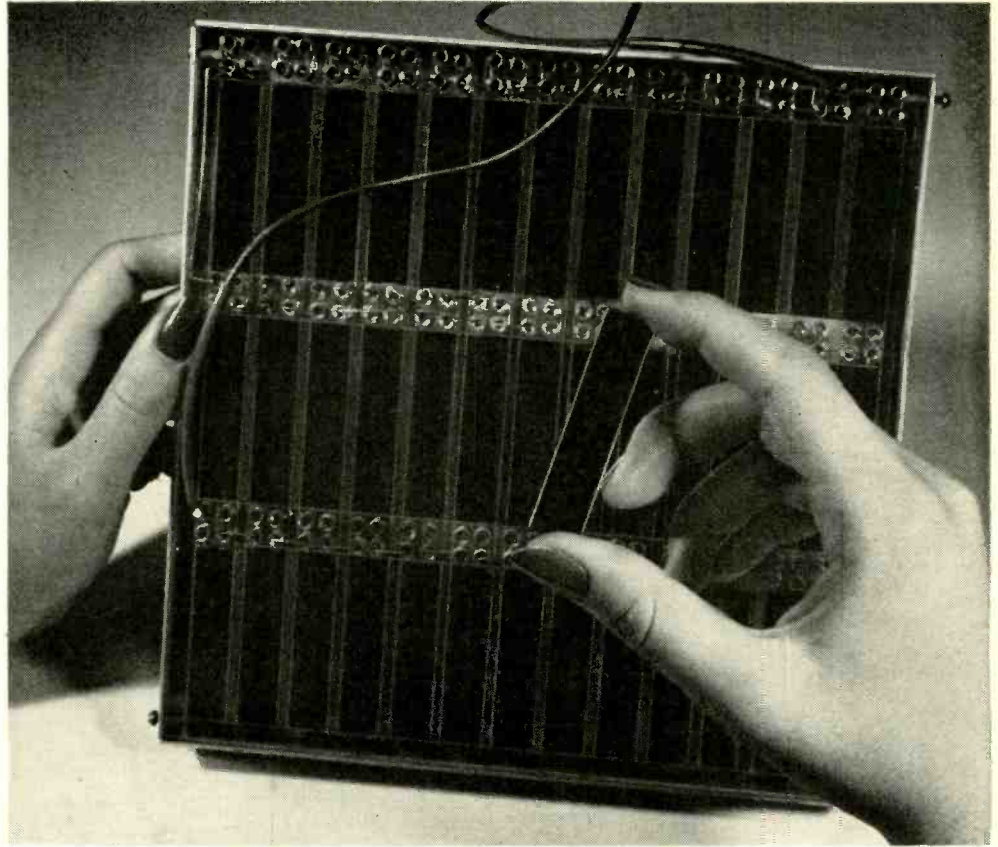

Bell Solar Battery

Bell Laboratories scientists have created the Bell Solar Battery. It marks a big step forward in converting the sun's energy directly and efficiently into usable amounts of electricity. It is made of highly purified silicon, which comes from sand, one of the commonest materials on earth.

The battery grew out of the same long-range research at Bell Laboratories that created the transistor—a pea-sized amplifier originally made of the semiconductor germanium. Research into semiconductors pointed to silicon as a solar energy converter. Transistor-inspired techniques developed a silicon wafer with unique properties.

The silicon wafers can turn sunlight into electricity to operate low-power mobile telephones, and charge storage batteries in remote places for rural telephone service. These are but two of the many applications foreseen for telephony.

Thus, again fundamental research at Bell Telephone Laboratories paves the way for still better low-cost telephone service.



Inventors of the Bell Solar Battery, left to right, G. L. Pearson, D. M. Chapin and C. S. Fuller — checking silicon wafers on which a layer of boron less than 1/10,000 of an inch thick has been deposited. The boron forms a "p-n junction" in the silicon. Action of light on junction excites current flow.



BELL TELEPHONE LABORATORIES

IMPROVING TELEPHONE SERVICE FOR AMERICA PROVIDES CAREERS FOR CREATIVE MEN IN SCIENTIFIC AND TECHNICAL FIELDS

The BACKSTOP

STOPS co-channel and adjacent-channel interference caused by rear signal pick-up!

- Highest front-to-back ratio ever built into an antenna!
- No rear pick-up; eliminates "venetian blinds"!
- Largest screen area: 70 square feet!
- Very high all-channel gain. Incorporates basic Champion design, including Tri-Pole, with additional elements!
- Completely preassembled!

Table of Front-to-Back Ratios (Relative Voltage)

Channels	Front-to-Back Ratios
2	9:1
3	10:1
4	11:1
5	20:1
6	18:1

Only Low Band channels shown, since co-channel interference is not encountered on High Band channels.

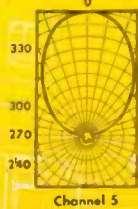

IMPORTANT... don't be misled by polar patterns representing relative POWER. Remember, power is the square of voltage. All Channel Master polar patterns are presented in relative VOLTAGE.

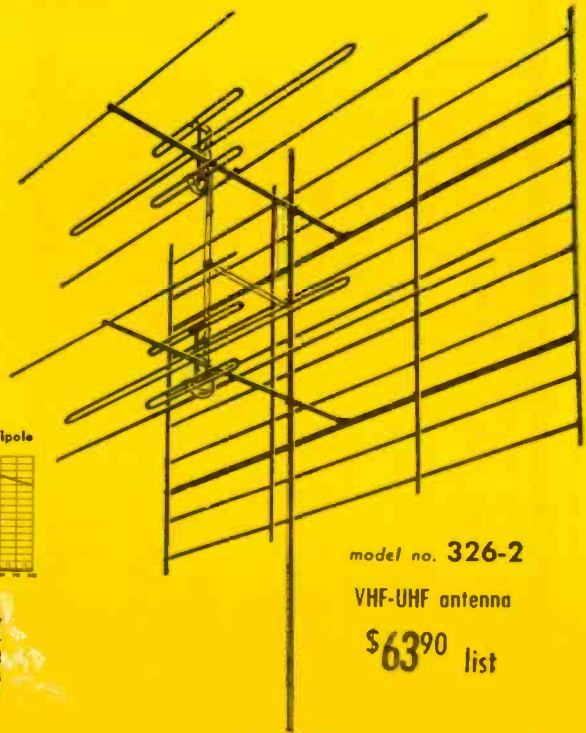
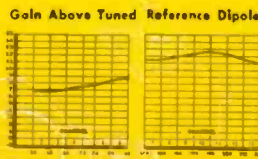

model no. 326-2

VHF-UHF antenna

\$63⁹⁰ list

2 radical new antennas by CHANNEL MASTER

The most beautiful antenna ever made! The only indoor antenna featuring powerful outdoor design principles — Bow-Tie and Screen.

Wonder Bow *

VHF-UHF
indoor
antenna

DESIGNED FOR POWER!

On UHF: For primary and secondary areas. In many cases, performance is equal to actual outdoor installations. Good directivity on all channels.

On VHF: Ideal in areas of strong VHF signals.

STYLED FOR BEAUTY!

Designed by a well-known industrial designer, the WONDER BOW is proof that indoor antennas can be beautiful as well as powerful. Wins customer approval on beauty alone!

The first gain figures ever to be published for an indoor antenna!

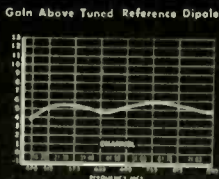

Gold and black

model no. 416

Silver and black

model no. 417

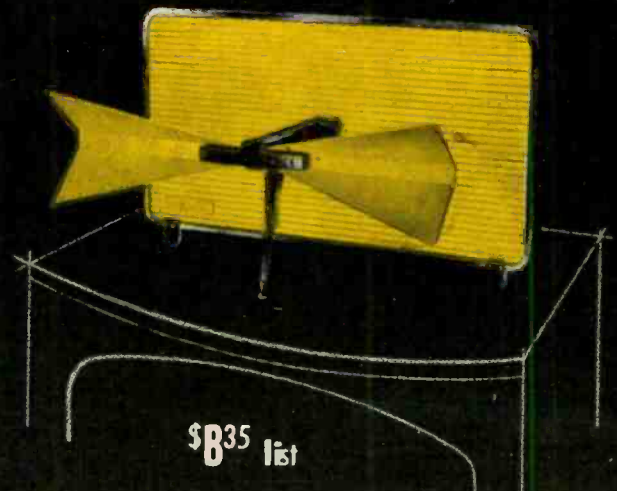

\$83⁵ list



CHANNEL MASTER CORP. ELLENVILLE, N. Y.

The World's Largest Manufacturer of TV Antennas

Write for complete technical literature.

Copyright 1954, Channel Master Corp.

*Pat. No. D-171560

NOW... 2 SENSATIONAL EICO SCOPE VALUES!

NEW AMAZING FEATURE PACKED
7" PUSH-PULL OSCILLOSCOPE

Only EICO Has All These Features

- VERTICAL FREQ. RESPONSE: flat ± 2 db 10 cps - 1 mc
- VERTICAL SENS.: .01 volts rms/inch
- HOR. FREQ. RESP.: flat ± 0 db 10 cps - 200 kc, -4 db at 500 kc
- HOR. SENS.: .3 volts rms/inch
- SWEEP RANGE: 15 cps-100 kc
- 3-STEP FREQ.-COMPENSATED ATTENUATOR eliminates freq. distortion, overloading.
- CATHODE FOLLOWER inputs to both amplifiers
- PUSH-PULL outputs in both amplifiers
- RETURN TRACE BLANKING
- INT. VOLTAGE CALIBRATOR
- V & H TRACE EXPANSION & CENTERING: 1.5X full screen without distortion.
- DIRECT CONNECTION to vert. CRT plates.
- PHASING CONTROL of internal 60 cps sine wave sweep.
- AT FRONT PANEL: Intensity mod. input; 60 cps, sawtooth outputs.



MODEL 470K
KIT \$79.95. WIRED \$129.50.

EICO EXCLUSIVE! 5" PUSH-PULL SCOPE, 425K,
Amazing feature-packed economy-priced
Wired, \$79.95. KIT, \$44.95.

- PUSH-PULL V & H amplifiers. Sens: 0.5-1 rms v/in. Useful to 2.5 mc.
- SWEEP. 15 cps-76 kc. Z-axis intensity modulation. Dual trace positioning controls.

SCOPE VOLTAGE CALIBRATOR KIT
495K KIT \$12.95. WIRED \$17.95.

- Sq. wave output at power-line freq. with full-scale readings of 1, 10, 100 V. peak-to-peak
- Accuracy $\pm 5\%$ of full-scale on each range.

6V & 12V BATTERY ELIMINATOR KIT
1050K KIT \$29.95. WIRED \$38.95.

- DC output: 0-8 V or 0-16 V.
- Continuous current rating: 10 A at 6 V, 6 A at 12 V.
- Intermittent current rating: 20 A at 6 V, 12 A at 12 V.
- Separate voltmeter & Ammeter.



NOW! ONLY EICO KITS & WIRED INSTRUMENTS Gives You LIFETIME SERVICE & CALIBRATION GUARANTEE*

*at less than our cost of handling (See EICO Guarantee Card enclosed with each Kit & Instrument).

221K VTVM KIT \$25.95. WIRED \$39.95.

- AC & DC volts: 0-5, 10, 100, 500, 1000 V (30 KV with HVP-1 probe).
- 5 ohm ranges from .2 ohm to 1000 megohms.
- DC input Z 26 megohms.
- 4 1/2" meter movement in cant'-burn-out circuit.
- 1% mult. resistors.



HIGH VOLTAGE PROBE \$6.95

- Extends range of VTVMs & voltmeters to 30 KV.

CATHODE RAY TUBE CHECKER
630K, WIRED \$24.95 KIT \$17.95



- Checks all types of TV picture and C.R. tubes in the set or carton. Bridge measurement of peak beam current (proportional to screen brightness).
- Detects shorted & open elements

625K TUBE TESTER KIT \$34.95. WIRED \$49.95.



- Illum. gear-driven "Speed Rollchart."
 - New lever-action switches for individual testing of every element.
 - Tests all conventional & TV tubes.
- PIX TUBE ADAPTER for Tube Testers \$4.50. Checks TV picture tubes while in set.

360K SWEEP GEN. KIT \$34.95. WIRED \$49.95.

- Continuous coverage of all TV & FM freqs. from 500 kc to 228 mc.
- Sweep width variable 0-30 mc.
- Crystal marker oscillator, variable amplitude.

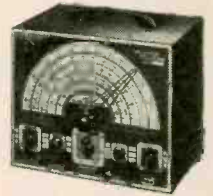

214K VTVM KIT \$34.95. WIRED \$54.95.
249 K P-P KIT \$39.95 WIRED \$59.95



- Large 7 1/2" meter, cant'-burn-out circuit.
- AC/DC volts: 0-5, 10, 100, 500, 1000 (30 KV with HV Probe).
- 5 ohms ranges from .2 ohm to 1000 megohms.
- DC input Z 26 megohms.
- 1% mult. resistors.

Large 7 1/2" meter

950A-K R-C BRIDGE & R-C-L COMP. KIT \$19.95. WIRED \$29.95.

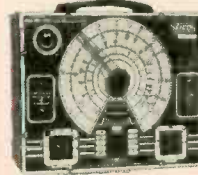

- Measures & tests all resistors; 5 ohm to 500 megohms.
- Every type condenser, 10 mmf to 5000 mfd.
- 0-500 DC voltage source for capacitor leakage testing.

BAR GENERATOR 352K, WIRED \$19.95 KIT, \$14.95

- Enables rapid adjustment of TV picture V & H linearity without hard-to-find station transmitted test pattern.

- Produces 16 V or 12 H bars. Operates on TV channels 3, 4, or 5.



Prices 5% higher on West Coast. Specifications and prices subject to change without notice.

New! EICO SCOOPS!

232K PEAK-TO-PEAK VTVM with DUAL-PURPOSE AC/DC *Uni-Probe* *
KIT \$29.95 WIRED \$49.95



Measures directly p-p voltage of complex and sine waves: 0-4, 14, 42, 420, 1400, 4200 V p-p. DC/RMS sine voltage range: 0-1.5, 5, 15, 50, 150, 500, 1500 v. Ohms: 0-1000 megohms. 7 non-skip ranges on every function. Calibration without removing from cabinet. Zero center. Freq. Resp. 30 cps-3mc. 1% precision ceramic multipliers. Exceptional stability and accuracy. Compact, portable (8 1/2"x5x5"), smart, rugged.

NEW! UNI-PROBE! Terrific time-saver! Only 1 probe for all functions—a half-turn of probe-tip selects DC or AC-OHMS!

249 K PEAK-TO-PEAK VTVM with 7 1/2" METER KIT \$39.95 WIRED \$59.95

944 K FLYBACK TRANSFORMER AND YOKE TESTER
Kit \$23.95 Wired \$34.95

Tests all flybacks and yokes, in or out of TV set—in just seconds! Detects even 1 shorted turn! Exclusive separate calibration for air—and iron-core flybacks assures utmost accuracy. Large 4 1/2" meter, 3 colored scales. Compact, portable (8 1/2"x5x5"), smart, rugged.



1171K RES. DECADE BOX KIT \$19.95 WIRED \$24.95
DECADE CONDENSER BOX KIT \$14.95 WIRED \$19.95
RTMA RESISTANCE SUBSTITUTION BOX \$11.00 WIRED \$9.95 KIT \$5.50

315K DELUXE SIG. GEN. KIT \$39.95. WIRED \$59.95.

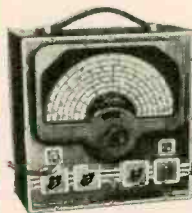

- Covers range of 75 kc to 150 mc.
- 7 calibrated scales: accuracy better than 1%.
- Bandsread vernier tuning.
- 4-step RF shielded output multiplier: constant output Z.

377K SINE & SQUARE WAVE AUDIO GEN. KIT \$31.95. WIRED \$49.95.



- Complete sine wave coverage, 20-200,000 cps in 4 direct-reading ranges.
- Complete square wave coverage, 60-50,000 cps.
- Cathode follower output circuit.

536K MULTIMETER KIT \$12.90. WIRED \$14.90.
526K MULTIMETER KIT \$13.90. WIRED \$16.90.



- 1% Precision resistors.
- 1000 Ω /V, 31 ranges
- DC/AC volts: Zero to 1, 5, 10, 50, 100, 500, 5000.
- DC/AC Current: 0-1, 10 ma; 0.1, 1 A.
- Ohms: 0-500, 100 K, 1 meg.

565K MULTIMETER KIT \$24.95 WIRED \$29.95.



- 555K MULTIMETER KIT \$29.95 WIRED \$34.95. (1% precision resistors)
- 20,000 Ω /V; 31 ranges.
 - DC/AC/output volts: 0-2.5, 10, 50, 250, 1000, 5000.
 - DC Current: 0-100 ua; 10, 100, 500 ma; 10 A.
 - Ohms: 0-2K, 200K, 20 meg.

145K SIG. TRACER KIT \$19.95. WIRED \$28.95.

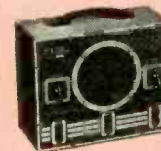

- Audibly signal traces all IF, RF, Video & Audio circuits from ANT to SPKR or CRT in all TV, FM, AM, etc. without switching.
- Germanium crystal diode probe responsive to over 200 mc.
- Integral test speaker.

320K SIG. GEN. KIT \$19.95. WIRED \$29.95.
322K SIG. GEN. KIT \$23.95. WIRED \$34.95.



- Fundamentals 150 kc to 34 mc, harmonics to 102 mc.
- 5-step band switching.
- Colpitts audio oscillator generates 400 cps pure sine wave voltage.
- Permits pure RF, modulated RF, or pure AF.

Write NOW for FREE latest Catalog C-7

Ask your jobber for FREE EICO business building decals.

Separate Assembly & Operating Manuals supplied with each EICO KIT!

You build EICO Kits in one evening, but... they last a lifetime!

SAVE OVER 50%! See the famous EICO line TODAY, at your local jobber.

ELECTRONIC INSTRUMENT CO., Inc. 84 Withers Street, Brooklyn 11, N. Y.

Our
25th Anniversary

**RADIO -
ELECTRONICS**

Hugo Gernsback, Editor

Radioelectronics in 1980

. . . To read the Future aright, we must look back to the past . . .

TWENTY-FIVE years ago this month saw the birth of this publication—then named RADIO-CRAFT. Conceived and founded by the present writer, he stated the future publication's platform in these words in the opening—July 1929—issue:

" . . . RADIO-CRAFT will be a strictly-specialized class publication, covering only a restricted field, namely: Radio set builders, radio constructors, short-wave fans, service men, amateurs (hams) and television enthusiasts."

Through the years, this broad policy has kept pace with the rapidly, ever-expanding radio-electronic field. Certain departments of the publication have been expanded—or contracted—to stay abreast of the changing times.

Let us now take a quick look at the radioelectronic age of the 1929 vintage, which, from this distance, in time-progress, may surprise us.

In 1929, many of our radio receivers then in use were still battery-operated. The house-current a.c. or d.c. sets were gradually coming into favor. In 1929 there were less than 11 million radio sets in use in the U. S. In 1953 there were over 118 million. Most of the present-day radio tubes were unknown—the screen-grid tube had just been brought out, coast-to-coast broadcasting hookups were entirely via land lines—the coaxial cable still was in the future, as was microwave relay cross-country transmission. Television still was in the rotating, Nipkow disc stage—the modern TV picture tube was in the blue-print, laboratory stage. In 1929, there were no transistors, no light portable radios with concealed aerials, no pocket radios, no hi-fidelity, no FM broadcasting, no beam-power tubes. Servicing instruments were few and crude. There were no signal tracers, no magnetic recording tape, no selenium rectifiers, no germanium rectifiers, no proximity fuse, no radar, no guided missiles, no electronic instrument landing for airplanes, no handy-talkies, no two-way taxi radio, no telemetering, no appliquéd (printed) circuits, no radio astronomy, no electronic computers, no Ultra-High-Frequency transmitters, no intercoms, no atomic batteries, no solar batteries and several hundred other radioelectronic inventions commonplace today, but unknown in 1929.

Since we developed these almost incredible marvels in a short twenty-five years, what—from this vantage point of accomplishment—can we expect at the end of the next twenty-five years, say by 1980?

We shall try here to describe only a few rather "safe" predictions, which appear reasonably certain—the too-fantastic ones unmentioned here will also sound commonplace by 1980.

▼ **Semiconductor Boom.** The semiconductors germanium and silicon, which now begin to rival the vacuum tube in the form of the transistor, the crystal diode, the photo transistor, as heavy current rectifiers and as a converter of solar power, will probably be responsible for major and far-reaching developments during the next quarter-century. We have but made a start in this direction, with the greatest electronic inventions yet to come.

Germanium and silicon are only two semi-conductors now in this field—there will be many others, all with different functions and purposes. There will also be *autopowered* radio-active semiconductors that can generate their own current—a start of which was made in the atomic battery.

▼ **Atomic Power via Semiconductors.** The writer has pointed out a number of times that atomic power today is grossly inefficient. To harness it now, you throttle down the atom and in the process obtain a large percentage of un-

wanted heat. Some of this heat then creates steam in a boiler which finally is used to run an electric generator. Most of the heat, however, is lost by "shielding", to do away with harmful radiation. Yet *this powerful radiation is electromagnetic in nature*—but so far has never been used efficiently. It seems very likely that in the future we may use *semi-conductors for a dual purpose*—for shielding and absorbing gamma and other atomic radiation, *while the shielding itself simultaneously will generate useful electric current.* When we do this, the atomic airplane and automobile will be the next logical and practical step.

▼ **Self-Powered Radios.** The 1980 radio receiver will bear little resemblance to the present-day type. For the most part, radios will be *much smaller* than the ones we now know. For home and office use, they will be mostly functional and utilitarian. They will be combined with cigarette-boxes, book-ends, table lamps, ash-trays, desk clocks, fancy ink-stands, calendars, paper-weights—or in combination with these.

Large radios will be in the minority, except in combination with TV and high-fidelity phonograph sets. There will no longer be a reason for large radios, because the 1980 type has no tubes and all the components are minute, compared to those in use today.

▼ **Cordless Radios.** You will no longer "plug in" a radio receiver twenty-five years hence, *for it will be completely self-powered.* The transistors (or a transistor combination) will generate all the necessary power atomically, hence the future radio will cost very little to operate for years. Yes, it will have to be serviced once in a while by a service technician, because even the radio set of the future may go out of order.

▼ **Battery-less, Auto-powered Pocket Radios** will be made in profusion by 1980. They, too, will come in a variety of styles: Pen-radios, cigarette case-radios, compact vanity-case radios for milady, and many other types come to mind.

▼ **Smaller Television Receivers** for black and white and multichrome reception will surely supplant our present day, cumbersome and bulky sets. Auto-powered and transistor-equipped, the size of our TV receivers will shrink in bulk from 50% to 75%. The great depth of present-day sets, due to the long bottleneck of our picture tubes will not prevail in the future. The picture "tube" of 1980 will probably be less than 3 inches deep, against 15 to 28 inches of our present-day tubes. The scanning means (if we still scan in 1980) will probably be a sort of electronic pantograph which will operate *from the top or side*, parallel to the face of the tube rather than at right angles (perpendicular) to it, as the tube's electron gun does today.

This arrangement also will make it possible to produce light-weight compact TV portables weighing less than 8 lbs. With an interior built in antenna, such portables can readily be carried from room to room, for traveling purposes, for the office, for picnics or the beach.

▼ **Phoneview—TV over the telephone**—proposed by the writer as early as 1910, will surely be commonplace by 1980. No longer will the telephone be "blind" in the future. Once we become accustomed to seeing each other during telephone conversations, we will marvel at how we ever lived without it.

Long an engineering project of the Bell Telephone Laboratories and already partially realized, *Phoneview* seems assured once we shall have produced a simplified and compact picture tube that does not require high-voltage to operate it. It probably will be a reality long before 1980.—H.G.

The Color CRT

By LEONARD LIEBERMAN

AS in the early days of monochrome, color TV circuitry will show a wide variation from set to set. An example of this situation can be seen in the color C-R tubes. Old-timers will remember a similar condition in the early days of monochrome when high-voltage supplies used 60-cycle a.c., r.f. and fly-back systems.

Many variations of color C-R tubes have been patented. At present, there are only two types either at or approaching the production level. These are the post-deflection focus type Lawrence Chromatron (Fig. 1) and the shadow-mask type represented by the CBS Colortron and the RCA 15GP22 (Fig. 2). Competition will probably result in a single standard picture tube.

While the various combinations of electrostatic and electromagnetic systems call for different circuits, the fundamental principles of monochrome C-R tube operation are the same. These are: the formation, focusing, and deflection of the electron beam. In color TV, the picture tube not only must perform these functions, but also must direct the beam to the exact color phosphor at the precise moment that color signal is at the signal input point.

The major difference in the various C-R tubes is in the method of directing the beam to the proper color phosphor. In the shadow-mask tube, a triangle consisting of the three color-phosphor dots (a triad) is located under a small hole (Fig. 3). An electron beam or beams are directed through the hole to the proper color at the proper time.

In the post-deflection focusing tube (PDF) the screen consists of the three colors in stripes. Between the electron gun and screen are one or two grids located close to the screen (Fig. 4). By adjusting the voltage on the grids the beam can be directed to the proper color stripe. The proponents of the PDF tube claim a 50% greater light transfer efficiency as against a three-gun shadow-mask tube.

The shadow-mask tube

A side view of the shadow-mask tube is shown in Fig. 5. The phosphor screen

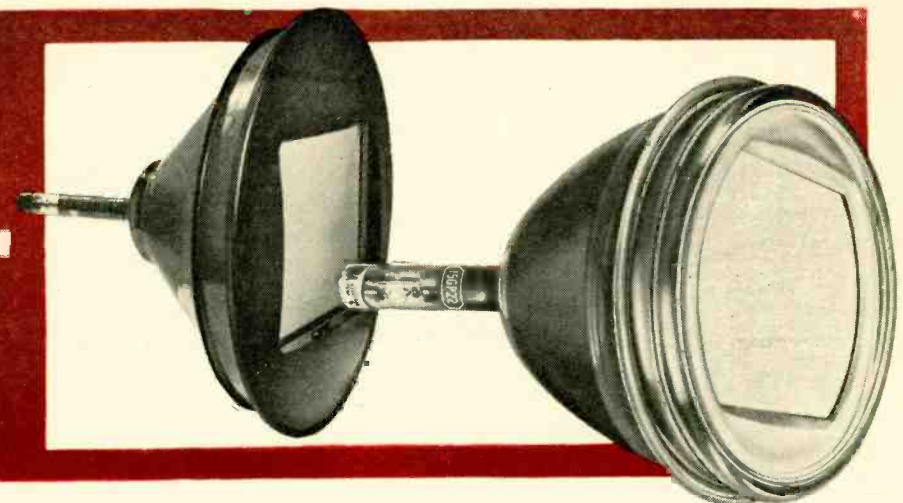

Fig. 1—Left, the Lawrence Chromatron.

Fig. 2—Right, the tricolor 15GP22.

contains approximately 600,000 dots in groups of three. Each triad consists of a dot of green, red, and blue fluorescent phosphor. Each dot is placed in its spot in a very precise manner. One of the differences between various shadow mask manufacturing processes lies in the manner that these dots are formed and located.

Between the phosphor screen and the electron gun is an opaque shadow-mask panel, which gives this type tube its name. This panel is a precision-machined piece of metal with approximately 200,000 holes. These holes are accurately spaced and positioned so that when the mask is correctly located, each hole lies in proper relationship to a triad.

The electron gun structure can consist of either one or three individual guns. In the one-gun tube the beam is put through the screen aperture hole and, using external circuitry, is rotated so that it enters the aperture hole, striking each dot in the triad sequence. The current shadow-mask tubes are the three-gun type. Fig. 6 shows these guns located 120° apart and concentric with the axis of the tube.

In this tube, each color gun is complete, with an individual cathode, control grid, and screen grid. The heater is common to all the guns. In addition, there is a common electro-static focusing electrode and a common convergence electrode.

In most color TV receivers the three cathodes are tied together to provide a common brightness control. The signal from each of the color channels is applied to its respective color-gun control grid (Fig. 7). In operation, each of the color signals is applied to its control grid simultaneously, and the three beams are formed, focused, and deflected to the proper aperture hole. By the construction of the guns, and by external circuits each color beam is made to strike the proper color dot in the triad on the screen (Fig. 8).

The mechanical problem of keeping the three beams focused and converged while scanning the entire screen is shown in Fig. 9. In position A, the

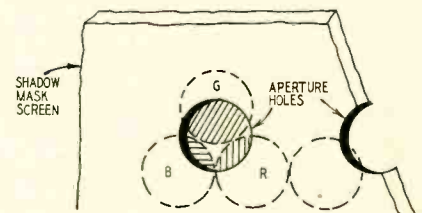

Fig. 3—Color triad as seen through a screen aperture by electron gun.

three beams are directed to the center of the screen and are converged and focused properly. Because the screen and mask are flat while the beams are deflected in an arc, the three beams would not strike the aperture hole if no correction were applied as in position B. With corrections as shown at C, the beams are made to focus and converge at the hole.

With respect to convergence, there is a difference between the RCA 15GP22 and the CBS Colortron. This is in the shape of the shadow mask and of the glass plate on which the phosphor dots are set. In the RCA tube the mask and plate is flat, and in the CBS tube they are spherical. The spherical shape makes the problems of dynamic focusing and convergence simpler because the correction distance at the ends of the sweep is not as great. However, some dynamic convergence and focusing is still required.

The convergence correction consists of applying a waveform to the d.c. potential on the focusing and convergence elements in the C-R tube. These waveforms are obtained from the circuit shown in Fig. 10. Pulses are taken off the cathodes of the vertical and horizontal output tubes and coupled to the input of the convergence amplifier. The potentiometer and adjustable coil phase the horizontal and vertical waveforms with respect to each other and to the start of the sweep.

The output of the dynamic convergence amplifier is applied through two transformers to the convergence electrode. The taps insure that the voltage ratio between the dynamic convergence

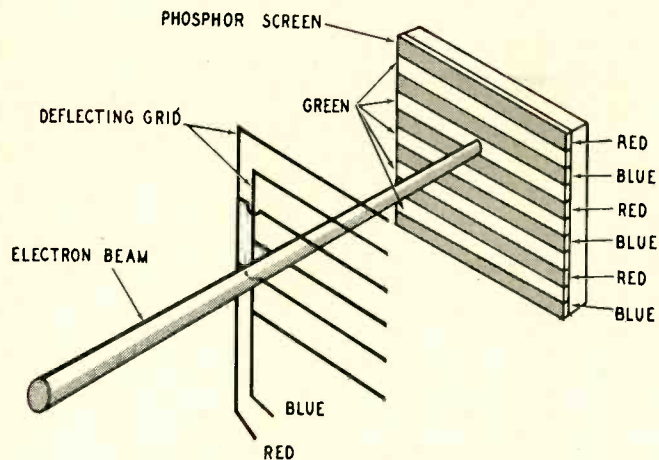

Fig. 4—Lawrence tube deflecting grid.

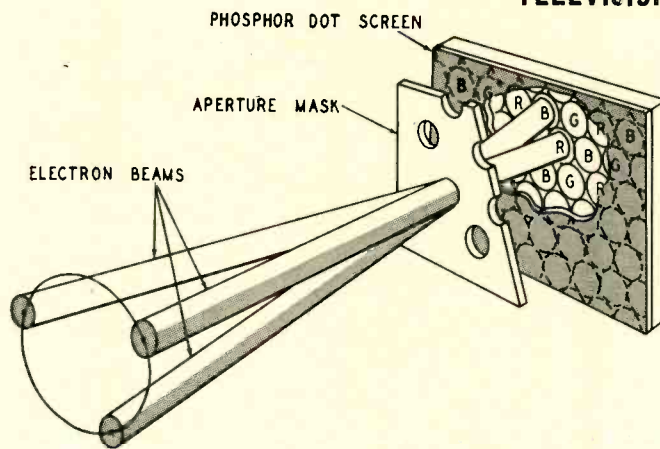

Fig. 8—Shadow-mask beam convergence.

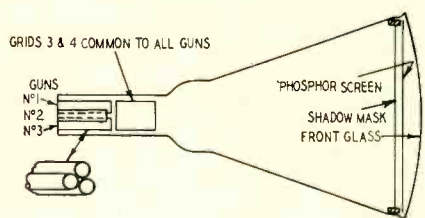

Fig. 5—Side view of shadow-mask tube.

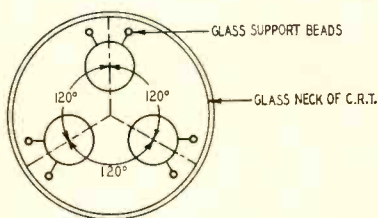

Fig. 6—Location of electron guns.

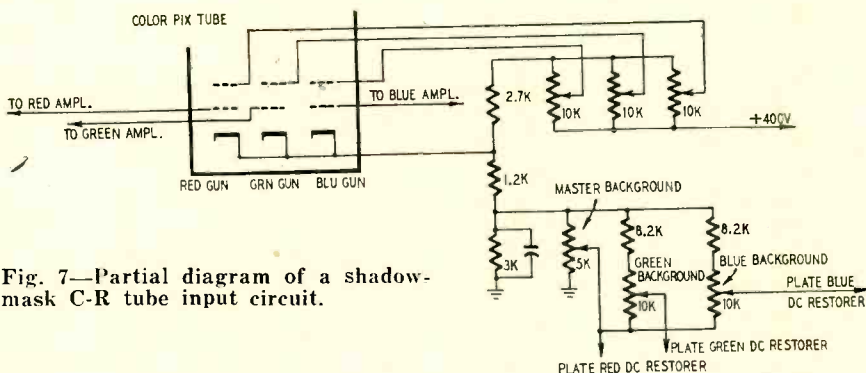

Fig. 7—Partial diagram of a shadow-mask C-R tube input circuit.

ments align the three beams in relation to each other and to the deflection axis of the neck.

One other operating requirement of this tube concerns the high voltage. Because the brightness signal is mixed directly with the chrominance signal and the cathodes are usually tied together, separate d.c. restoration is required for each color gun. Since brightness level is one of the elements of the picture, variations in beam current from any gun because of fluctuations in the high voltage will result in a distorted color picture. This makes a well-regulated high-voltage supply a very important requirement.

Post-deflection focusing

The Chromatron is based on the tube developed by Dr. Lawrence. In this, as in the shadow-mask tube, either a single- or three-gun system can be used.

grids between the gun and the screen. This is done not only so that the beam can be focused past the grids, but also to control the beam, so that it strikes the color stripes in the correct sequence. The colors are arranged in the sequence RGBGRGB.

In the single-gun system, the voltages on the grids are set so that when the voltages are equal the beam will go straight through to the stripe directly ahead. By varying the voltage relation, the beam can be deflected in an action similar to that of electrostatic deflection. In this case the electrostatic deflection of the beam doesn't sweep the tube face, but is micro-deflected only across a three-stripe color section. The focusing action of the grids are the same as in the three-gun tube.

The voltage on the grids is varied at a sine-wave rate. The simplest rate to use for this purpose is the 3.58-mc color subcarrier frequency. (The voltage of the sine wave is approximately 400 peak-to-peak.) This voltage is obtained by using the capacitance between the grids and connecting an external coil between them. This L-C circuit can be designed to resonate at 3.58 mc. The circuit Q is high and the current requirement is low—close to 25 watts of r.f. power is required.

Fig. 13 shows the position of the beam in relation to the switching sine wave. As the sine wave goes through zero the beam is on the green stripe. Because of this one of the suggested systems for using the PDF tube is that the input grid be keyed by the 6th harmonic of 3.58 mc so that the color signal be at the input in the following rotation: GRRGBB.

Advantages and disadvantages

The advantages of the single-gun PDF tube lie in the simplicity of the color decoding which is inherent in a single-gun system, ease of C-R tube construction which makes it possible for the developers to talk of a 24-inch-face tube by next year, and also a slightly higher light transfer efficiency from the glass face. It has several disadvantages such as noticeable horizontal line structure in the current models

and dynamic focusing electrodes is kept constant. The d.c. voltages for these electrodes are obtained from different sources. The convergence d.c. voltage is tapped off the high-voltage supply. The focus voltage comes from a rectifier in the horizontal output transformer circuit; a variable control in the cathode return circuit of the rectifier serves as the focus control.

Two other controls, external to the neck of the tube, are required for the operation of the three-gun shadow-mask C-R tube. They are the beam-position magnets (permanent magnets) and the purity coil. These two adjust-

The single-gun system is simpler to operate than the shadow-mask tube. Fig. 11-a illustrates the relationship of the grid and the screen. The screen consists of stripes of color phosphors. The beams are deflected as in the shadow-mask tube. A voltage (approximately 4.5 kv) is applied to the grid wires, which focus and converge the beams as they pass the wires (Fig. 11-b). The second anode voltage is 18 kv.

Present indications are that a single-gun type will become standard. Fig. 12 shows a cross-section view of one line in the one-gun tube. This tube has two

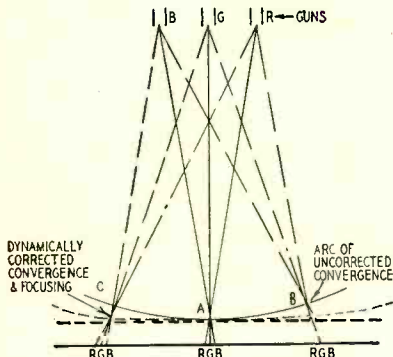

Fig. 9—Shadow-mask tube convergence.

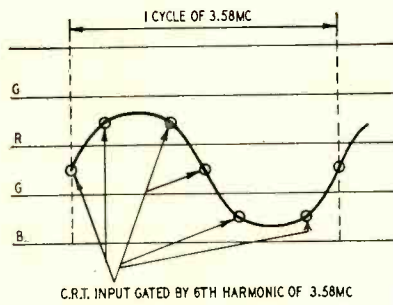

Fig. 13—Path of the electron beam when switched at a sine-wave rate.

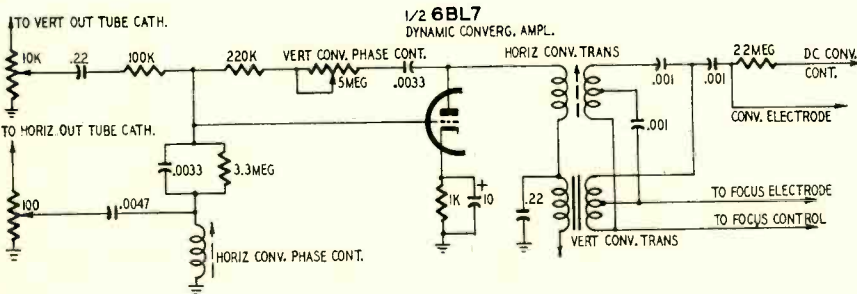

Fig. 10—Dynamic convergence circuit. Output is fed to convergence electrode.

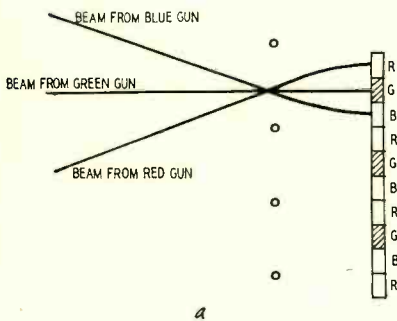

Fig. 11-a—Convergence of the three beams. 11-b—Focusing field in PDF tube.

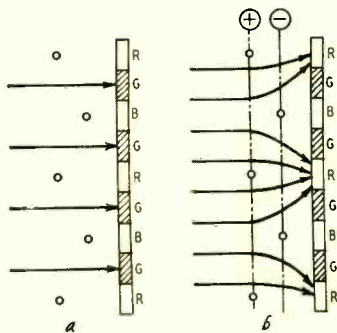

Fig. 12-a—Beam strikes green when voltage on both grids is equal. 12-b—Beam action as one grid voltage becomes more positive than the other.

when viewed from close up and the radiation resulting from the 25 watts of r.f. from the switching circuit.

The shadow-mask tube also has a number of disadvantages as well as advantages. Its advantages are that only the desired dot is struck by the beam, no complex switching system is needed, and there is no problem of color registration. On the other hand, the

shadow-mask tube has a number of serious drawbacks. The precision-machined parts, the extra convergence and focusing circuitry, the highly accurate high-voltage regulation required, and the small angle of deflection with its attendant small screen and long tube bell are among the disadvantages. The last-mentioned defect is one of the main reasons for the small (8½ x 11½-inch) screens—whose reign was just being broken when this article was written, by Du Mont's demonstration of a 19-inch tube and RCA's announcement of the imminent introduction of a 19-inch type, with even bigger tubes promised for 1955.

Servicing color C-R tubes

If, as it seems at present, the color tube is shipped separately from the set, the service technician will have to know how to set up the tube. It is therefore worth while to study the adjustments of the tube which the service technician most likely see first, the shadow-mask. After the tube is mounted in position in the set, the external units

are mounted on the tube neck. Turn the grid 2 (screen) voltage controls to minimum and the bias controls to maximum bias. Connect the tube socket and the high-voltage anode. Apply voltage to the set. After the tube has warmed up, increase the voltage on grid 2 of the red gun. At the same time, reduce the bias voltage of that gun until the screen lights up.

Purity coil adjustment

When the screen lights up, move the deflection yoke approximately one-quarter inch from the bell of the tube. Increase the voltage adjustment control of the purity coil. Move the purity coil along the neck of the tube while simultaneously rotating it in a manner similar to the way the ion trap is adjusted on the present monochrome set, until a pure red can be seen in the center of the screen. Then slide the deflection yoke back toward the bell of the tube until a uniform red color is seen on the entire screen. The other guns are then adjusted in the same manner, by varying the voltage control of the purity coil. Since the adjustments are interacting, it might be necessary to go back and touch the coils and the purity-coil voltage control until all the colors are uniform in turn.

In the purity coil are three beam-positioning magnets. To adjust these magnets as well as the convergence controls, a dot generator is required. With the generator output connected to the input of the video amplifier, the beam-positioning magnets are adjusted so that an equilateral triangle consisting of three adjoining color dots is produced in the center of the screen.

Convergence adjustments

The d.c. convergence controls are adjusted so that the three colors form a white dot in the center of the screen. The dynamic convergence controls are used to make adjustments at the edge of the screen. The horizontal dynamic convergence control is used to cause the dots to merge into white in the horizontal direction at the sides of the screen. The vertical dynamic control does the same thing for the dots in the vertical direction.

Color balance

The final adjustments are those concerning color balance, done in the following manner:

1. Adjust the voltage on the three screen grids (grid 2), to the same value.
2. Set the bias on each gun so that the screen has a grayish color.
3. Increase the brightness with the master brightness control and note which color seems to predominate.
4. Reduce the grid 2 voltage on the gun which predominates.
5. Repeat steps 2 and 3 until no one color predominates when the master brightness control is advanced to maximum.

END

COLOR

TV

CIRCUITS

THERE are many circuits in a color TV receiver that are required regardless of the type picture tube used—whether it be the three-gun dot type, the shadow-mask tube of RCA and CBS (*Colortron*), or the single-gun Lawrence (*Chromatron*) strip type tube.

The luminance channel in a color receiver consists of a number of video amplifiers identical to those found in a monochrome receiver, with the addition of a delay line and a 3.58-mc trap. The luminance channel has the same function as the video amplifier in a monochrome receiver in that it amplifies the luminance or monochrome portion of the color signal.

Fig. 1 shows the composite color video signal from the video detector coupled to the first video amplifier and then separated and fed to four different circuits: second video amplifier through a delay line, bandpass amplifier, burst amplifier, and sync separator for horizontal and vertical deflection synchronization. The sync separator and assorted circuits were covered in our previous article and the burst amplifier will be discussed in a future article.

A 4.5-mc trap is shown (Fig. 2) in the luminance channel to prevent interference patterns in the picture—the identical function of a 4.5-mc trap in a monochrome video amplifier. The two additional components not found in a monochrome video amplifier are the 3.58-mc trap and the delay line. The 3.58-mc trap performs two functions: it keeps the color burst and subcarrier (color information) out of the luminance channel to prevent an interfering dot pattern in the picture, and it acts as a pick-off coil for the signal coupled to the burst amplifier. The delay line slows up the luminance (monochrome) signal so that it arrives at the mixing (matrix) circuits at the same time as the chrominance (color) signal.

The delay line is necessary because, after the take-off from the first video amplifier, the chrominance signal must pass through the bandpass amplifier, demodulators and phase inverters, while the luminance signal usually passes through only one additional amplifier stage before being applied to the matrix circuits. The chrominance or color signal has a longer signal delay due to the greater number of stages (and also due to its narrower frequency band-

Part II—The luminance and bandpass circuits

By KEN KLEIDON AND PHIL STEINBERG*

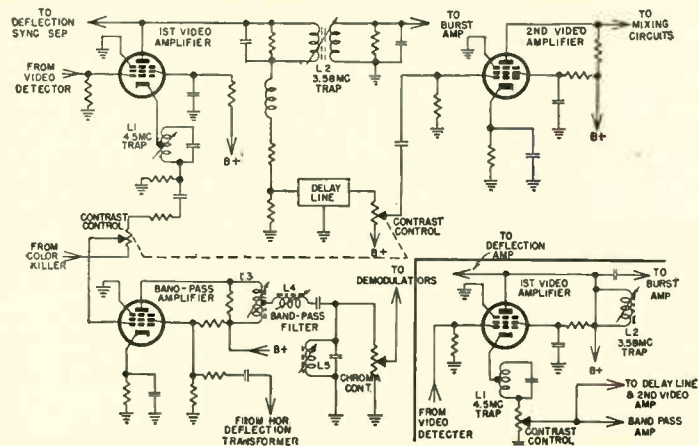
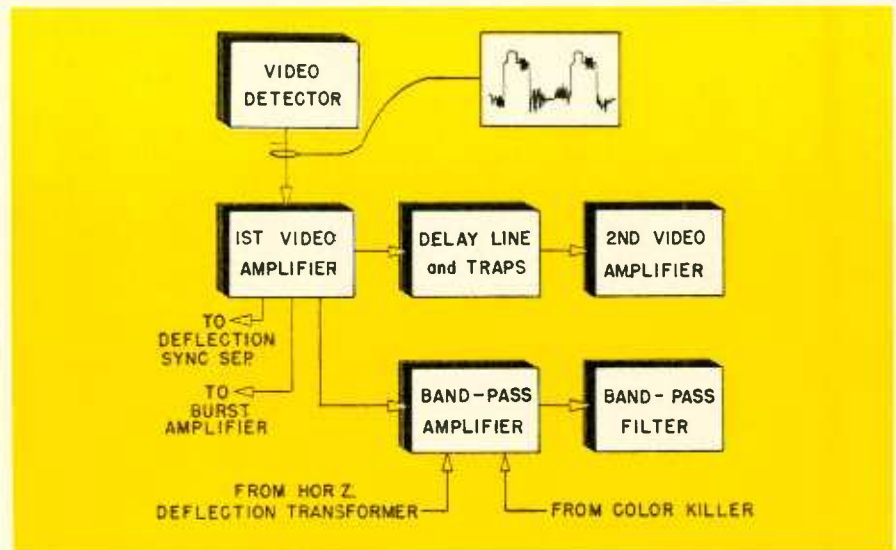

Fig. 1—Top, diagram shows signal path following the video detector.

Fig. 2—Bottom, schematic shows circuits as indicated in Fig. 1.

width as compared to the luminance signal), and therefore the 1-microsecond delay line in the luminance channel synchronizes the two signals at the matrix circuits where the final color signals (red, green, and blue) are obtained.

To illustrate the need for a delay line in a color receiver, a comparison can be made to color printing. A familiar occurrence is the appearance of a

blurred color picture in a newspaper or magazine due to the fine-detail black-and-white printing being offset from the color printing. Similar results would occur if the delay line was not included in the luminance channel. Fig. 3 shows a typical delay line (actually one-half of a delay line—two identical lines are used in series). The delay line is simply a number of coils (22 for two lines in series) in series with terminating

*Raytheon Manufacturing Company, Television and Radio Division.

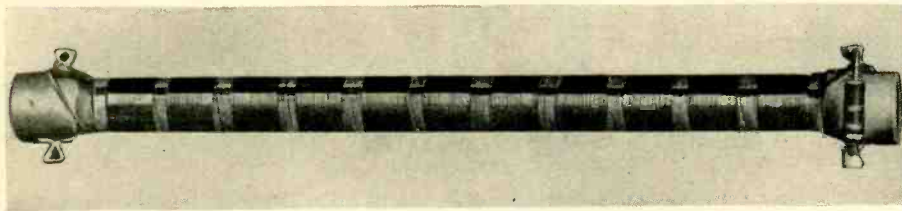

Fig. 3—Typical delay line—a series of coils terminating in resistors at ends of line.

resistors at either end of the line.

The second stage (some color receivers may employ three stages) in the luminance channel is a conventional video amplifier which builds up the luminance signal to the proper amplitude for application to the mixing circuits. The frequency pass-band at the output of the luminance channel is shown in Fig. 4.

As in a monochrome receiver a contrast control is included in the luminance channel to vary the gain. Two contrast-control hookup arrangements may be found in a color receiver, depending on the design of the luminance channel. In one case the contrast control is located in the first video amplifier's cathode circuit and the signals to both the bandpass amplifier and second video amplifier are coupled to their respective circuits from the center arm of this control. The other arrangement uses a dual contrast control. One section is located in the first video amplifier's cathode circuit and is used as a take-off point for the chrominance signal applied to the bandpass amplifier. The other control section is located in the plate circuit of the first video amplifier and varies the luminance signal to the second video amplifier. In either case a constant relationship is maintained between the luminance and chrominance signals. The two contrast-control hookup arrangements are shown in Fig. 2.

The contrast control in a monochrome receiver is a handy tool for the service technician and will prove just as useful when servicing color receivers. Whenever a service condition of "no picture—no sound" (raster normal) occurs, varying the contrast control will indicate which circuits are at fault. As a fast check to localize the possible cause of a "no picture—no sound" condition, observe the face of the picture tube at both maximum and minimum contrast-control settings. If no appreciable change is noticed between the two control settings, the trouble is usually in the last two or three i.f.-amplifier stages up to the sound take-off point. If at the maximum control setting an increase in snow is noticed, the trouble is most likely in the tuner or first or second i.f. amplifiers, or the antenna may be disabled.

Since color receivers will probably be of the intercarrier type, both the sound and video information are amplified simultaneously by the tuner and majority of the i.f. amplifiers. Therefore, if the sound appears to be normal, it can be assumed that there are no defects in the tuner and i.f. amplifiers up to the

sound take-off point. A no-picture condition with normal sound (raster normal) would probably be caused by a defect between the sound take-off point and the picture tube. If such is the case, rapidly changing the contrast control setting should produce a flicker effect in the raster if the luminance channel between the contrast control and mixing circuit is functioning properly. This will further localize the cause of the trouble.

The luminance channel should be serviced carefully. Rearrangement of leads and components could possibly cause regeneration, especially in those receivers where the first and second video amplifiers are in the same glass envelope. Since the input and output of any two-stage amplifier has the same signal polarity, it is always a good practice to keep the output leads and components as far from the input as possible. Stray wiring capacitances have a much greater effect at higher frequencies and could easily cause a ringing effect in the picture, very similar in appearance to ghosts. The delay line can be checked with an ohmmeter. Checking continuity from input to output of the delay line will determine whether it is open or of correct resistance, and measuring across either input or output terminals to chassis will determine whether it is shorted.

Bandpass amplifier

As mentioned previously, the composite color video signal from the video detector (Fig. 1) is coupled to the first video amplifier and then separated and fed to four different circuits, one being the bandpass amplifier. The bandpass amplifier selects the chrominance or color information (consisting of the color subcarrier and its upper and lower sidebands) from the composite color video signal and amplifies this color information sufficiently to feed the demodulators. The bandpass amplifier as shown in Fig. 2 is simply a tuned amplifier, similar to an i.f. amplifier except that it operates at video frequencies. The bandpass filter, which is the frequency determining factor of the amplifier, is placed in the plate circuit as in an i.f. amplifier. The bandpass characteristics will vary depending on the type of demodulators used and the i.f. amplifier response. Some manufacturers may peak the high-frequency response of the bandpass amplifier to compensate for the deficiencies in the i.f. amplifiers due to narrow bandwidth. The frequency passband at the output of the bandpass amplifier is shown in Fig. 4 and represents the bandwidth

for the R-Y and B-Y demodulator system in dotted lines and the I-Q demodulator system in a solid line. The only difference is that the bandwidth for the I-Q system extends lower in frequency than the R-Y, B-Y system. Demodulators will be discussed in a future issue.

The two signals, from the color killer and horizontal deflection transformer, applied to the bandpass amplifier (see Fig. 1) are necessary in a color receiver for the following reasons: The signal from the horizontal deflection transformer is a negative pulse which is applied either to the control grid or screen grid of the bandpass amplifier, depending on the design of the receiver, to keep the color burst out of the chrominance channel. This pulse occurs during the horizontal blanking interval and prevents the bandpass amplifier from conducting for the duration of this pulse. If the color burst were allowed to pass through the bandpass amplifier, it would be demodulated and passed to

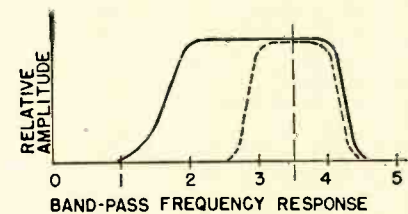
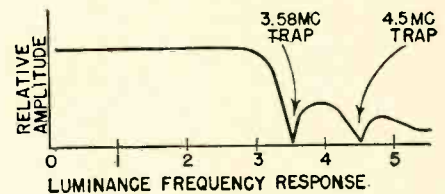

Fig. 4—Luminance channel pass-band.

the blue grid of the picture tube as a pulse of about the same magnitude as the sync pulse. This would cause an undesirable change in blue background as the signal varies from channel to channel or from color to monochrome, due to the action of the d.c. restorer for the blue gun. The signal from the color killer is simply a negative bias voltage which holds the bandpass amplifier cut off during monochrome reception to prevent noise from passing through the chrominance channel and affecting the picture. Some receivers may not include the stage required for an automatic color killer but will provide a

switch which disables the B plus to the bandpass amplifier and accomplishes the same purpose.

Fig. 2 shows the chroma control at the output of the bandpass filter. This control varies the amplitude of the chrominance signal to the demodulators which in turn affects the saturation or intensity of the colors appearing on the face of the color picture tube. The chroma control will be provided on the front of the receiver as the only added customer's control necessary for color operation. For the customer the chroma control will affect the intensity or shading of the various colors. As an example, increasing the chroma control setting will vary the red portion of the picture from a pink to a light red, to a deep red, or will vary the blue portion of the picture from a light blue to a medium blue, to a deep blue.

Servicing hints

Servicing a color receiver will be, approximately 75% of the time, identical to servicing a monochrome receiver. Since the N.T.S.C. system is compatible, a color receiver is capable of receiving a monochrome transmission in black-and-white. Because of this, the service technician can check reception on both color and monochrome signals as an aid to localizing troubles. If trouble is experienced when tuned to a color program, the first step should be to check the picture when tuned to a monochrome program. If the same trouble is noticed on both a color and a monochrome program, the monochrome circuits in the color receiver are at fault. However, if the trouble disappears when tuned to a monochrome program, the color circuits are at fault. It must be assumed that the picture-tube controls are correctly adjusted when making this check.

Whenever it is determined necessary to check the bandpass amplifier, this stage should be treated identically to an i.f. amplifier and serviced accordingly. Alignment of the bandpass amplifier, as any tuned circuit in a color receiver, should be performed according to the manufacturer's alignment instructions, and the specified procedure should be carefully followed. A typical alignment procedure specified by one manufacturer is simply to feed an unmodulated signal to the grid of the first video amplifier and connect an a.c. voltmeter across the chroma control. L3-4-5 are adjusted for maximum reading at the frequencies listed in the alignment procedure.

The bandpass amplifier, sometimes referred to as the chrominance amplifier, selects and amplifies the color information; therefore any defects that occur in this stage may cause a loss of color on the face of the picture tube and result in a monochrome picture. The bandpass amplifier, color killer, and the color subcarrier oscillator and control circuits are the only stages that could cause a complete loss of color and result in a monochrome picture when tuned to a color program. (TO BE CONTINUED)



JULY-SEPTEMBER

If reports received in the first few months of 1954 are any indication, this year will break all TV dx records by a wide margin. The first four months of 1954 have already yielded about 150 sporadic-E reports, nearly twice last year's complete record for the same period, and May observations are piling in rapidly. From coast to coast, and from Yellowknife, Northwest Territory to Buenos Aires, Argentina, come indications that 1954 is almost certain to be a banner year in TV dx circles.

The season opened ahead of previous years, with observers around the Gulf Coast reporting plenty of both sporadic-E and tropospheric dx as early as March. In fact, tropospheric dx seems to be an almost daily occurrence in that region, regardless of season. Several observers report that regular reception up to 300 miles or more is not at all uncommon, and when conditions really open up it's hard to identify one kind of dx from the other as the distances for the two forms often overlap.

Atlantic seaboard observers got in some early licks, too. The fourth week in April saw tropospheric dx ranging from Halifax to Virginia. Canning in Halifax identified stations on every channel except 9 the night of April 20th, his list including WCBS, WPTZ, WBZ, WNBC, WNBW, WABD, WFIL, WNAC, WABC, WNHC, WGAR, WPIX and WATV. He suggests that dx-ers be on the lookout for CHSJ, St. John, New Brunswick, Channel 4, a recent arrival.

This same East Coast inversion enabled Collier of Arlington, Va., to log 11 u.h.f. stations at distances of 150 miles or more. His best dx in this department included WICC-43, Bridgeport, Conn., 290 miles; WKNB-30, New

Britain, Conn., 330 miles; and WWOR-14, Worcester, Mass., 385 miles. He was also seeing WNAC-7, Boston, 420 miles.

Our most northerly observer to date is Glick, of Yellowknife, NWT, who sees KOOK-2, Billings, Montana, occasionally, and has received signals from Seattle as well. The southern extreme of our reporting range is Amaro Detry, Buenos Aires, who reports reception of PRF-3, Sao Paulo, Brazil. This is a 1200-mile hop, a common distance for E_s propagation.

We also have a few third-hand reports of reception of various South American stations in this country. Has anyone seen signals from the Argentine, Brazilian or Venezuelan stations sufficiently well to be positive of the identification?

What can we expect for the balance of the summer and through September? Well, the sporadic-E season should be just hitting its early summer peak as you read this. The closing days of June, and the entire month of July should provide frequent and widespread sporadic-E dx, 600 to 1200 miles being the most common distances. Be on the watch for multiple-hop effects also, as this is the season when it should be possible to pull in trans-continental dx, up to 2500 miles, interference conditions permitting. Eastern observers will find this most likely after about 10 pm EDST.

Sporadic-E dx will probably continue through at least the first ten days of August, though it will be tapering off in both signal strength and duration after the latter part of July. August and September will be more notable for tropospheric dx, however. September, particularly, should provide some really fine examples of this type of propagation. This is the season when the high channels go wild, and even u.h.f. may turn up some rather surprising stuff.

For best results in tropospheric dx work, watch for calm fair weather, possibly with gradually increasing cloudiness. The barometer will be high, or beginning to fall, as a storm area approaches after a protracted fair period. Paths along large bodies of water will open most often, but stable inversions capable of providing highband dx of 700 miles or more are quite capable of building up over our great plains states as well, at this season. Early morning, the period around sundown, and the hours after 10 pm or so are the favorable periods in the diurnal cycle. END



From the original "La Télévision? . . . Mais c'est très simple!" Translated from the French by Fred Shun-aman. All North American rights reserved. No extract may be printed without the permission of Radio-Electronics and the author.

Eleventh conversation: heterodyning in a television receiver

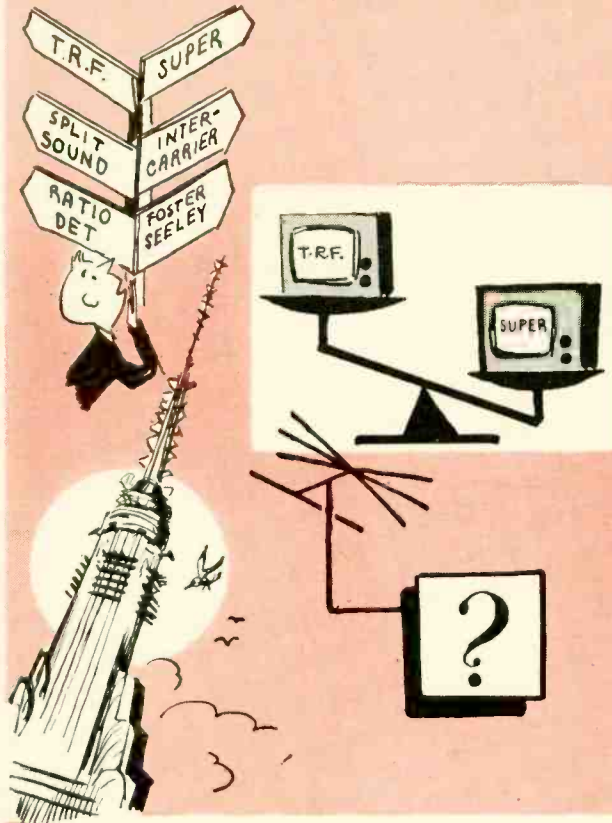

TELEVISION - - - It's a cinch

By E. AISBERG

WILL—I'm glad to see you again, Ken; I've been walking around with an awful empty feeling . . .

KEN—Why—what's the trouble?

WILL—Well, I feel something like a mother who abandons her child to run off to a bridge party. You remember, we left our waves carrying the TV image, sync signals and all that, floating around somewhere between heaven and earth . . .

KEN— . . . and now you want to bring all this high-frequency energy back down to earth . . .

WILL— . . . and use it to operate a TV receiver. Wasn't I supposed to be going to build one, as part of the job of learning how TV works?

KEN—And have you given your receiver any thought? Is it going to be a superheterodyne? Will it have a u.h.f. range? Or are you sticking to the v.h.f. for the present? Will . . .

WILL—Hold on a moment! I haven't had time to decide about all these things! Now this circuit question, for instance. You give me the idea I could use a t.r.f., but all the diagrams I remember looking at are supers.

KEN—I was kidding a little. You could use t.r.f. They do in England, where most sets are fixed-tuned, and get only one station. But the superhet is the universal circuit for TV reception today.

The superheterodyne TV receiver

WILL—I see you're making another one of those apple-box diagrams.

KEN—Will, you might as well learn to like these block diagrams! They're the best way to get a general idea of how assemblies are hooked together. Suppose I had a visitor who wanted to get acquainted with New York. Would I start in by taking him through all the picturesque lanes of Greenwich Village? Not at all; I'd take him to the top of the Empire State Building and give him a general view of the whole island. It's the same way with a TV receiver. If I were to draw a complete and detailed schematic for you at the start, all you'd get out of it would be a frustrated feeling!

WILL—Oh, that's O.K.! Don't get me wrong—I don't object to apple boxes. But talking of frustration—I can't make anything out of this at all!

KEN—Get a grip on yourself and take a look at the sound part! How different is it from the radio receivers we studied together years ago?

WILL—The sound part looks normal. But look—it and the video i.f. both share the same oscillator and mixer. That ought to be very economical, but can you get it to work?

KEN—Very well indeed! First of all, the r.f. amplifier is wide enough to cover a whole channel—including both video and sound—without too much trouble.

WILL—But how do you separate video and sound after the converter stage?

KEN—Nothing magic about that, either! The oscillator beats with the different video and sound carrier frequencies and produces two intermediate frequencies that can be separated by tuned circuits without any trouble.

WILL—I still don't dig it.

KEN—Let's suppose we're receiving channel 2, with the picture carrier at 55.25 mc and the sound at 59.75. Now, if we tune our oscillator to 101 mc, what will the sound and pix i.f.'s be?

WILL—For the sound we'll have:

$$101 - 59.75 = 41.25$$

and for the video:

$$101 - 55.25 = 45.75$$

KEN—And if you tune your sound and pix i.f.'s to those frequencies, you shouldn't have any trouble. That is one reason the superhet is almost universally used. We need selectivity. The tuned circuits have to be wide enough to

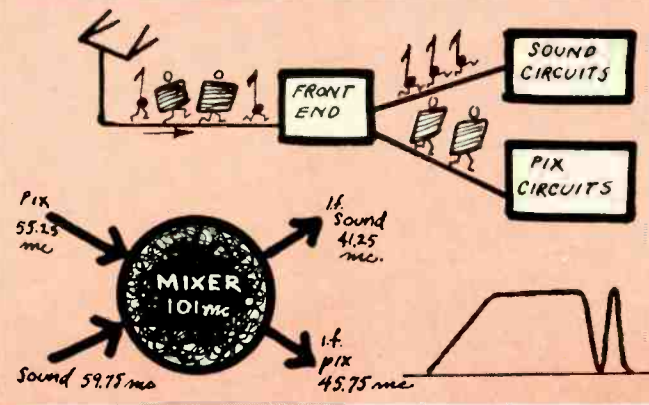
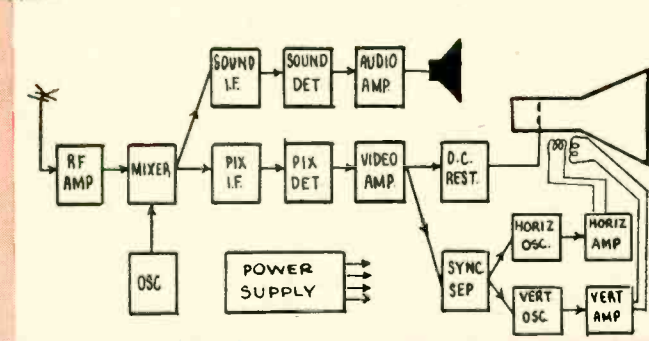

admit the whole band without attenuation, but the pix circuits have to keep the sound carrier and its sidebands out. So your selectivity curve must be flat and broad, yet have very steep sides. If not, you get sound mixed up with the picture. Then you really have trouble.

WILL—How? Does the picture-tube screen go into vibration?

KEN—Not quite as bad as that, Will! When you get sound in your picture, you have black and gray horizontal bars over your picture.

WILL—That wouldn't be so good either. And you can keep the sound and picture apart without too much trouble?

KEN—We-e-ll—not without trouble. . . . First, you must give your selectivity curve a shape that passes the whole video curve without letting the sound in. Since the i.f. circuits are tuned to fixed frequencies, they can be adjusted very accurately. So you can produce that broad, flat-topped curve by tuning one (for example) to a point near 43 mc, the next to 45.5 and the next one to a point between them. That is called *stagger tuning*. Or you can tune them all to a point near the center of the video i.f. band and couple them so close that the response at the center frequency drops and the curve spreads out, giving about the same effect. Second, you then use rejector circuits—called sound traps—to further reduce the sound signal.

WILL—So it does look as if the super is best?

KEN—Except possibly where the set is fixed-tuned to one station, as is usually the case in Europe, for example. But the super has one disadvantage. By its very nature, it produces interference that shows up . . .

WILL— . . . as whistles!

KEN—In an AM broadcast receiver, yes. But in TV, the interference takes the form of stripes and bars, moire patterns and other visible figures instead of anything you can hear. But this disadvantage is balanced out by many other features of the super. It would be almost impossible to tune a multistage r.f. receiver to all the channels of the upper and lower v.h.f. bands, to say nothing of the u.h.f. And we've seen that the fixed-frequency tuning of the i.f. circuits makes it easier to get a curve broad enough for the pix signals, yet sharp enough to separate the sound from the image. But a stable oscillator is very important. If it drifts just a little, it may have no effect on the picture, but the sound suffers because of its narrower bandwidth.

WILL—Why should a narrow bandwidth be so disastrous?

KEN—Well, suppose the oscillator changed from 101 to 101.1 mc, or 1 part in 1,000. You probably couldn't see the effect on the picture. The sound i.f. would move from 41.25 to 41.35 mc. Let's put it in kilocycles: The sound moves 100 kc, from 41,250 to 41,350. With a 25-kc deviation each side of the carrier, or a sound bandwidth of 50 kc, you can see that the new sound i.f. is completely outside the sound i.f. channel's passband. You wouldn't hear any sound at all.

WILL—Considering some of the jokes and commercials, not to mention the sopranos—would that be bad?

KEN—Making jokes about a thing is often an excuse for having no positive ideas in your head. Couldn't you think of some way of remedying the condition instead?

WILL—Just stabilize the oscillator better.

KEN—That's one way, and it works to a limited extent. Another is to make the passband of the sound i.f. broader than the range of frequencies it has to amplify. Thus you have a safety margin if the oscillator varies a little. More popular is the *intercarrier* system. Both sound and pix signals are carried through the same composite i.f. amplifier to the detector or video amplifier. Then the sound is picked off on an intermediate frequency of 4.5 mc produced by the *sound and picture carriers beating together*. This sound signal is amplified through one or possibly two stages at 4.5 mc and demodulated with an ordinary discriminator. The sound and pix signals then always stay the same distance apart, no matter whether the receiver oscillator drifts or not.

WILL—Sounds simple, but I can't figure it out at all!

KEN—Probably your brain has taken too much of a beating already today. Maybe we'd better continue our studies another time!

(TO BE CONTINUED)

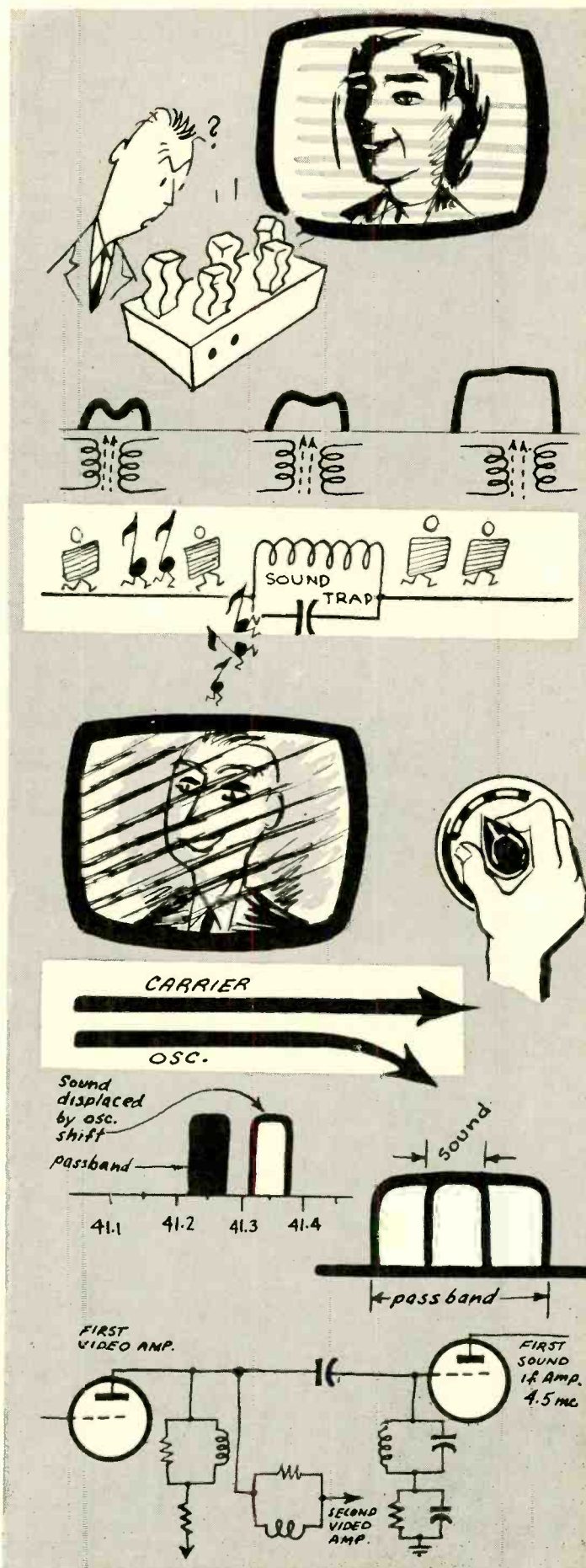

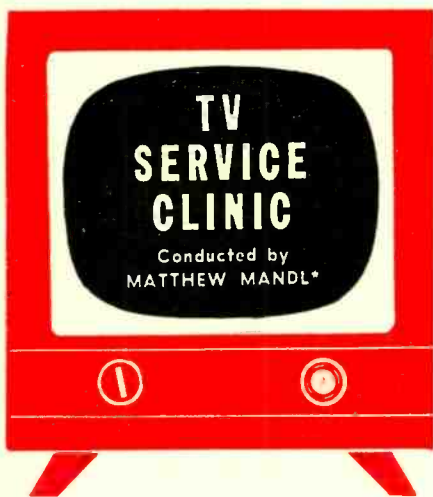

Fig. 1—Corner shadows on screen.

THERE is some disagreement among servicing technicians regarding the afterglow which occurs in some receivers after the receiver is shut off. Some contend that this is injurious to the tube and will eventually cause an ion burn. Others assert that the afterglow is no more serious than any white picture area which would occur during reception.

I am inclined to agree with the latter group, provided that the components on the neck of the picture tube have been properly adjusted. The vast majority of picture tubes currently in use utilize either the slashed gun or bent gun ion-trapping principle. This means that initially both the electrons and ions are deflected downward toward the gun structure. A beam bender is then used to exert a magnetic force to lift the electrons up so they will travel to the tube face. Since the mass of an ion is greater than that of an electron, the ion is influenced only slightly by the magnetic field and thus is not lifted up and propelled toward the screen. The beam bender (ion trap magnet) must be properly adjusted, however, so that the ions go through the gun aperture and do not strike the edges of the aperture. If the brilliancy control is turned high and the ion trap is misadjusted, electrons strike the rim of the aperture and decompose the metal. This may generate additional ions which can reach the tube face and damage the screen; and the circular aperture hole will be distorted, resulting in poor focus.

With a properly adjusted trap magnet, however, no ions will reach the tube face. When the receiver is shut off, the sweep fields collapse, causing the raster to shrink rapidly. Filter-capacitor charges maintain sufficient potential to cause electrons to reach the screen and produce the afterglow. Since the high voltage also is collapsing, the afterglow rarely has the intensity of a brilliant white portion of a televised scene. For this reason, little screen damage occurs even over extended periods of time. There are a number of 10-inch receivers still in use with no ion burn

*Author: Mandl's Television Servicing.

which have been subjected to persistent afterglow for years.

Some technicians advise the set owner to turn the brilliancy on full prior to shutting off the set so that the afterglow is eliminated. This may cause more damage in a short time than any afterglow could over extended periods. With the brilliancy control on full, and with more than normal high voltage, the picture-tube cathode emission can be impaired. If the ion trap magnet is not adjusted properly, the excessive setting of the brilliancy control will aggravate ion burn conditions. In our opinion, therefore, the ion trap should be adjusted properly and the receiver kept at normal brilliancy when turned off.

Proper adjustment of the ion trap magnet consists of rotating it with a forward and back movement until maximum brilliancy is obtained. If corner shadows are present as shown in Fig. 1 they should be eliminated by adjustment of the focus ring or focus-coil assembly. A misadjusted ion trap magnet will contribute to some corner shadow conditions but if the magnet is set for maximum brilliancy, any remaining corner shadows should be eliminated by the focus unit. Lately we have seen four receivers which have developed bad picture tubes within a year. In each instance the tube emission had declined to the point where brilliancy was extremely poor. In each instance, also, the owner had been told to turn the brilliancy up full before shutting the set off. It seems likely that the foregoing factors have contributed to the short-lived tubes, though of course the tubes may have developed defects for other reasons. We would be interested in hearing from readers regarding their experiences or opinions of the foregoing.

Sometimes statements appear in print which are in direct contradiction to design limitations. I once noticed a statement in the service notes of a well-known receiver which suggested misadjustment of the ion trap if difficulty is encountered in eliminating corner shadows. The service notes went on to say that the technician need not worry about ion burns because this manufacturer's brand did not develop

ion burns. Later I talked to one of the design engineers for this company and queried him about this statement. I also pointed out that I had seen a number of these receivers with pronounced ion burns in them. The engineer said, "Our tubes get ion burns as well as do other tubes if the trap is not adjusted properly. The statement in the service notes was the erroneous opinion of one of our technical writers."

Picture shimmer

What causes the background shimmering sometimes present in our area during u.h.f. reception? I am not referring to snow, weaving, jumping, or other types of interference. There is always some shimmering, but at times it is so decided, though it gets close to looking like snow and is very annoying. Is there any remedy for it? F.O.W., Evansville, Indiana.

In weak-signal areas there is some "signal to masking" effect. Under such a condition general noise pulses which are received or which are generated within the tubes are not sufficiently strong to produce snow, but still affect the horizontal line trace to a slight extent to produce the symptoms you describe. It is difficult to entirely eliminate the faint type of shimmering effects in weak-signal areas. Improvements consist of a higher or better antenna, plus better antenna orientation. The r.f. tube in the v.h.f. tuner also may be a contributing cause, and several should be tried so that one can be found which has a minimum of generated noise.

If the effects which you describe are not noticeable a few feet away from the receiver there would be little purpose in trying to correct the condition, since entire elimination of background effects is possible only in strong-signal areas.

Ringin coil Q

In a Westinghouse H-620 receiver, I have had trouble with poor horizontal synchronization. Normal adjustments did not help, nor did tube and part changes. I then modified the circuit according to the manufacturer's recom-

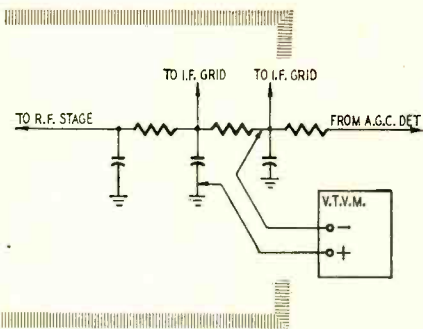

Fig. 2—Measuring the a.g.c. voltage.

mendations, but this did not cure the trouble entirely. The set would remain in good sync for a few days and then drift again. I then put a 22,000-ohm resistor across the ringing coil and re-adjusted the receiver. This cured the trouble except in one instance when the line voltage dropped below normal. Are there any other suggestions you may have to improve this receiver? W. G., New York City.

Since you have changed tubes and parts and modified the horizontal circuit according to the manufacturer's recommendation, the horizontal instability should have been minimized. These particular sets have been giving trouble of this sort and your use of the 22,000-ohm resistor across the ringing coil was a good idea. This broadens the Q of the coil and helps maintain stability. In this type of horizontal a.f.c. circuit, component parts and voltages are critical to maintain good synchronization, and if the line voltage drops below 110, considerable instability often occurs. In areas where line voltage fluctuations persist, a voltage-regulating transformer is necessary. In these receivers the horizontal output system also has considerable influence on horizontal stability because of a change in loading. Excessive current in the horizontal output section or a change of parts will thus affect the stability of the horizontal oscillator. Since the receiver is now fairly stable, there is little else that you could do except recheck alignment and make sure sync tips are of proper amplitude by checking with a scope.

Synchroguide adjustments

I am experiencing trouble with the synchroguide circuit of a Silvertone model 102-A receiver. I have checked all parts and also replaced the horizontal oscillator transformer. I then aligned the circuit in accordance with the instructions given in the service notes for this receiver.

I found that now I cannot get synchronization except by placing a shorting jumper between C and D of the Merit replacement transformer. G. R. P., Brigantine, N. J.

The fact that you get good stability

when you short C and D of the transformer indicates incorrect alignment of the horizontal a.f.c. system. If you align this with an oscilloscope having a shielded lead, you will be unable to get good results. Evidently the service notes did not emphasize that it is necessary to use unshielded leads or a low-capacitance oscilloscope input cable for observation of the waveform. If the system is adjusted with a high-capacitance lead, the shunting capacitance in the cable will alter the characteristics of the horizontal a.f.c. circuit and thus produce false waveforms on the oscilloscope. Try realignment according to the step-by-step procedures given in the service notes, using a low-capacitance scope cable.

Loss of brightness

I have converted an Admiral 20A1 for a 16DP4 tube. I have installed a Merit HVO-7 horizontal output transformer, a MDF-70 yoke, and the appropriate focus coil and width control. Linearity is good and there is sufficient sweep but the set lacks brightness. My measurements indicate only 9,000 volts. If I leave in the capacitor which connects from the secondary of the transformer to the grid of the 6BG6-G it upsets horizontal frequency. I have not changed the sweep circuits except to install the transformer and substitute new tubes. How can I get sufficient voltage? R. A., Brooklyn, N. Y.

The horizontal output transformer and yoke which you are using are intended for tubes having a deflection angle from 66 to 70 degrees. The 16DP4 tube has a deflection angle of only 60 degrees and should have had a transformer and yoke suitable for the lower deflection angle.

The Merit HVO-7 transformer will deliver 14,000 volts when properly installed. Such voltage, however, also depends on the proper function of the horizontal output tube circuit and the grid-drive signal. Adjust the drive just below the point where left-hand stretch or center compression of the picture occurs. This should be done with a station pattern or a cross-bar generator. Try various values in place of the original feedback capacitor to get the proper pulse amplitude for correct drive. You will also have to check the voltage-boost circuit because it may be applying excessive voltage to the original oscillator circuit via the 22,000-ohm resistor connected to the linearity coil. You may have to increase the value of this resistor to establish the former voltages at the plate of the 6SN7-GT oscillator to prevent loss of sync when the proper feedback pulse is applied. You will have some difficulty in correcting this if you continue to use 70-degree deflection components.

16GP4 to 21AP4 conversion

The RCA TC-165 receiver uses a 16GP4 picture tube. I would like to replace this with a 21AP4. Can I do

this without making circuit changes? H. S., Chula Vista, Calif.

The 16GP4 has a deflection angle of 70 degrees and operates with 11,700 volts on the high-voltage electrode in this receiver. The 21AP4 would give better definition and brightness at 16,000 volts, though direct substitution of the 21AP4 may work provided the original output system is operating at peak efficiency. If the high voltage is too low, some blooming and defocusing will result.

A.g.c. loss

I have an Arvin model TE-315-9 which develops trailing whites and turns partially negative when the contrast is turned up more than three-quarters of the way. The trouble started a day or two after WTMJ-TV (Milwaukee) changed to channel 4 and increased power. The antenna is a channel 3 Yagi, but since the set operated all right for a while, I haven't blamed the trouble on the antenna. I found several leaky capacitors and replaced them, and got peak performance again. This lasted only about two weeks, and on recheck, I found a number of other capacitors defective, plus several off-value resistors and weak tubes. I replaced all defective units, but the a.g.c. on the video i.f. tubes is positive. I assume the a.g.c. is inoperative, but can't seem to localize the trouble. Do you think the a.g.c. trouble is caused by the additional power of the station (which doesn't sound logical) or some trouble in the set? J. G. P., Waldo, Wis.

Since your initial replacement of defective components restored the receiver to peak performance for a couple of weeks, the trouble is not caused by an excessive signal from channel 4. An excessive signal normally creates a high negative a.g.c. bias. This in no way would cause repeated component breakdown or make tubes go defective. The fact that you found so many defective components and tubes when you rechecked the receiver simply indicates the results of normal aging of parts; or the troubles which occur if original parts and replacements are overloaded because of excessive line voltage; or some defective parts loading down others.

When a station is tuned in, a negative bias should be present at the grids of the video i.f. amplifiers (Fig. 2). The positive voltage probably indicates either leaky coupling capacitors, gassy or otherwise defective tubes, or open series resistors in the a.g.c. bus. Thus, you will have to make a thorough check of tubes and parts in the a.g.c. system as well as the video i.f. stages controlled by the a.g.c. Any defective part in one of these stages can cause a positive a.g.c. voltage to appear at the grid of the other circuits. If the receiver is tuned off a station, no negative a.g.c. bias should be developed, but the grids of the tubes should still not be positive. END

Most Useful TV Circuits of 1954

Westinghouse chassis V-2243-4 and V-2263

Models H-830K21, H-831K21, H-830KU21 and H-831KU21

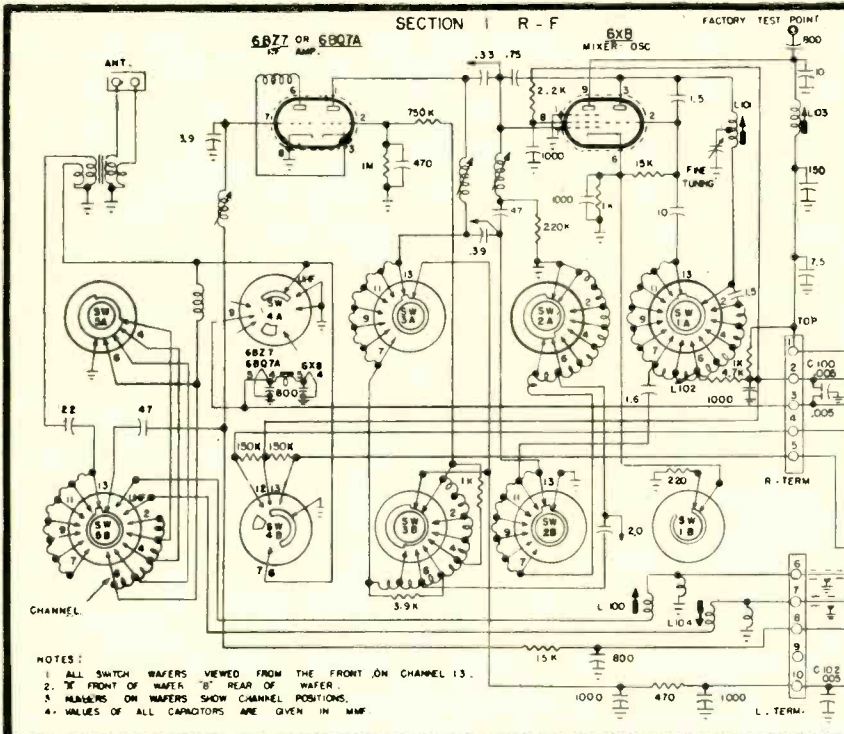

The 830 model numbers indicate mahogany cabinets — the 831's blond cabinets. The model numbers with a "U" indicate a V-2273 chassis. This is identical with the V-2263 chassis shown, with an additional u.h.f. tuner for channels 14 through 83.

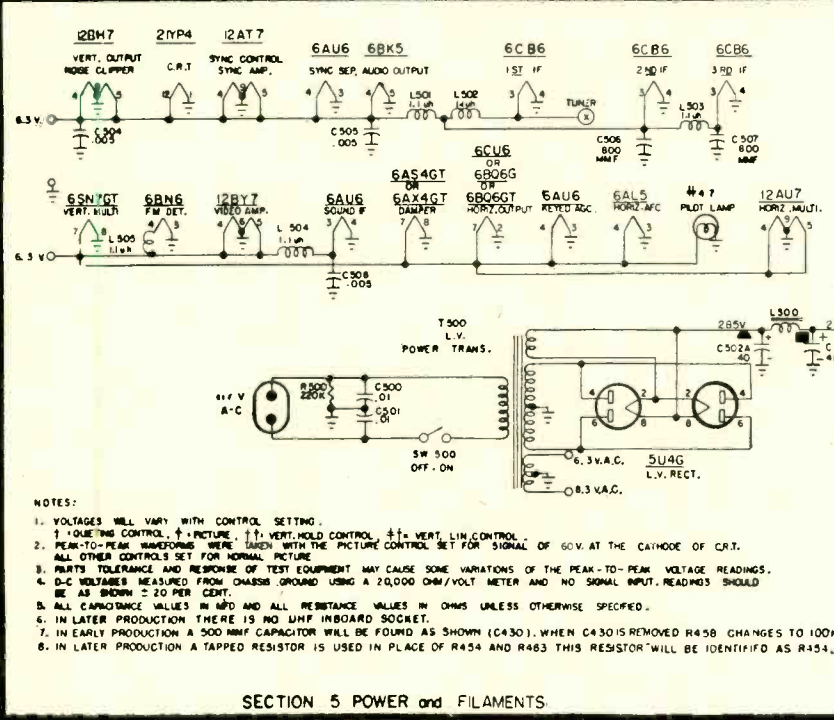
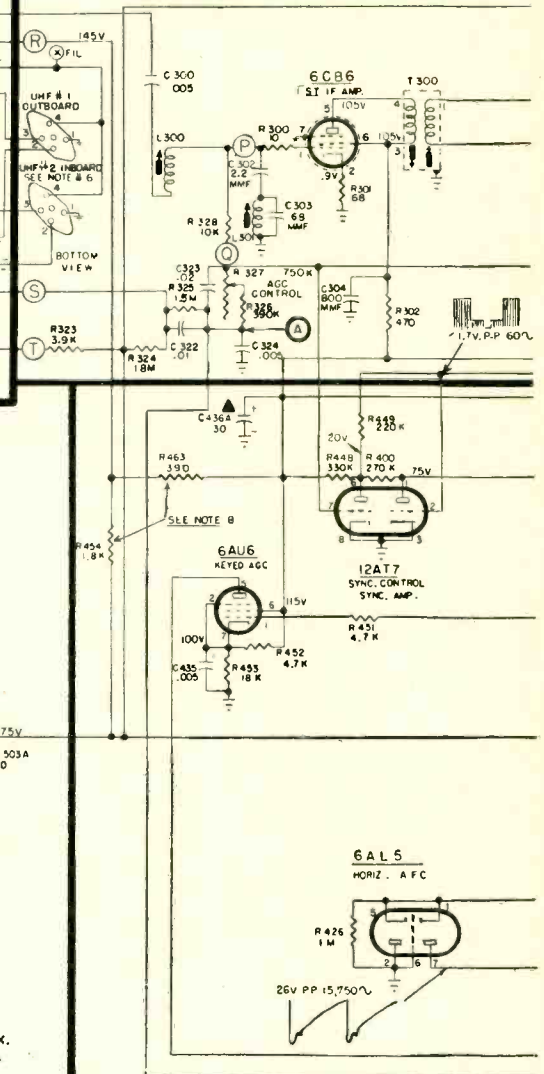

Several different combinations of u.h.f. and v.h.f. tuners are used in the V-2273 chassis. The dash number following the basic chassis number identifies these tuners. Refer to the following chart:

Chassis Number	V.H.F. Tuner	U.H.F. Tuner
V-2273-11	V-11794-1	V-12325-1
V-2273-12	V-12400-1	V-12390-1
V-2273-12A	V-12400-1	V-11972-1
V-2273-13	V-12100-1	V-12390-1
V-2273-13A	V-12100-1	V-11972-1

SECTION 2 SOUND I-F and AUDIO

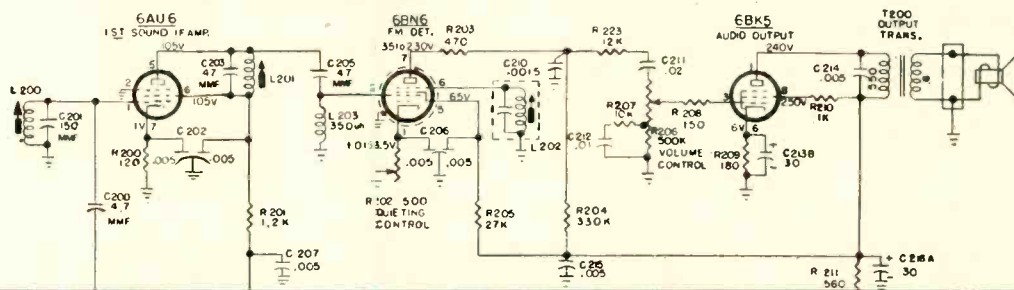

SECTION 3 VIDEO

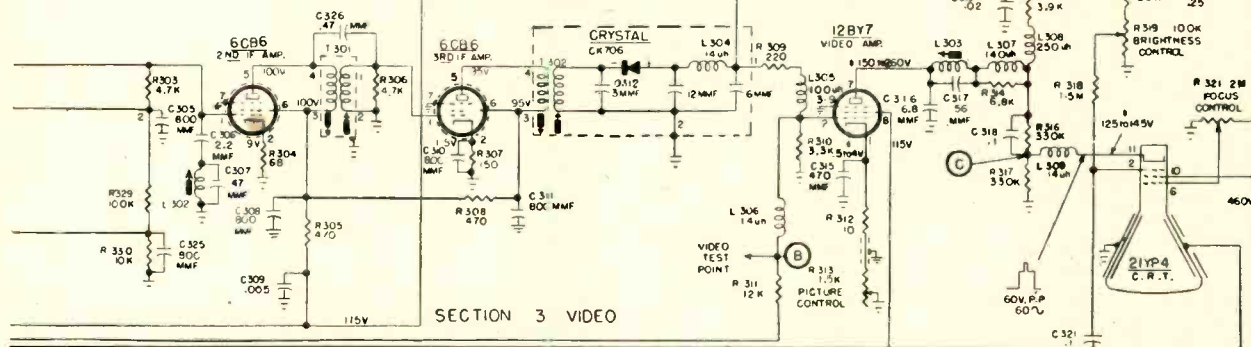

SECTION 4 SWEEP

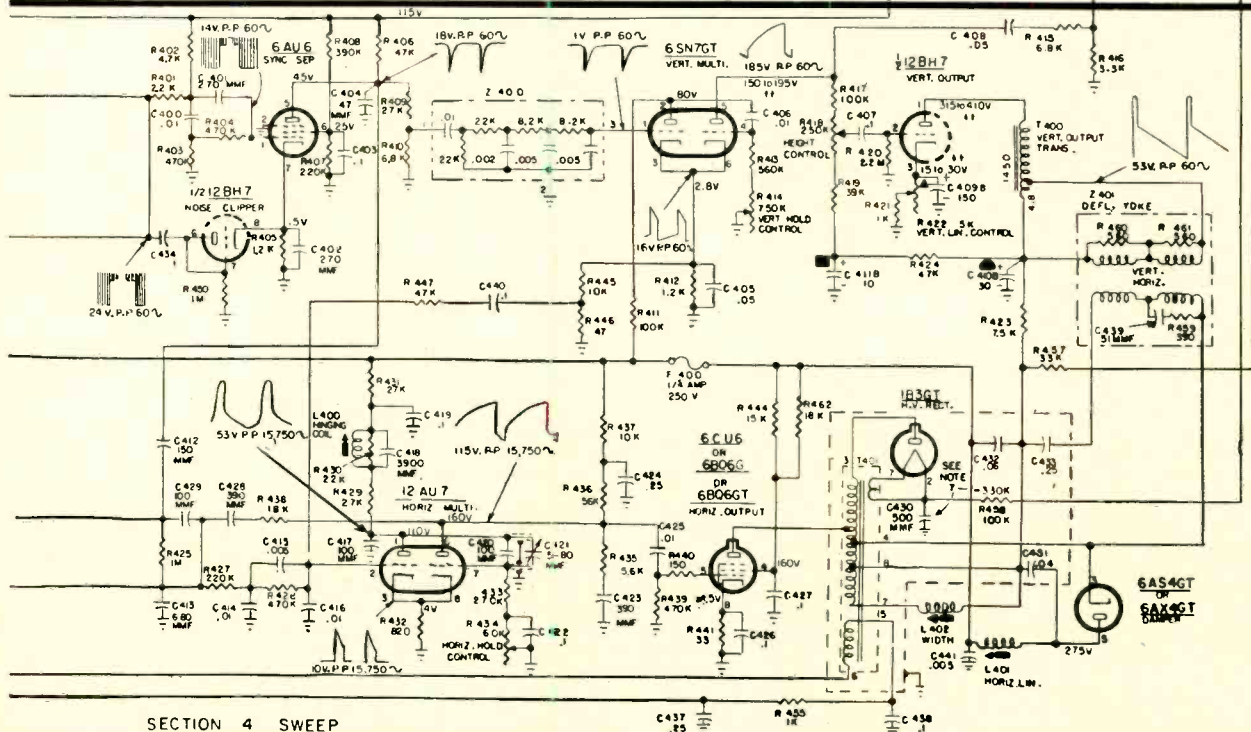

Stromberg-Carlson Series 21T-22T

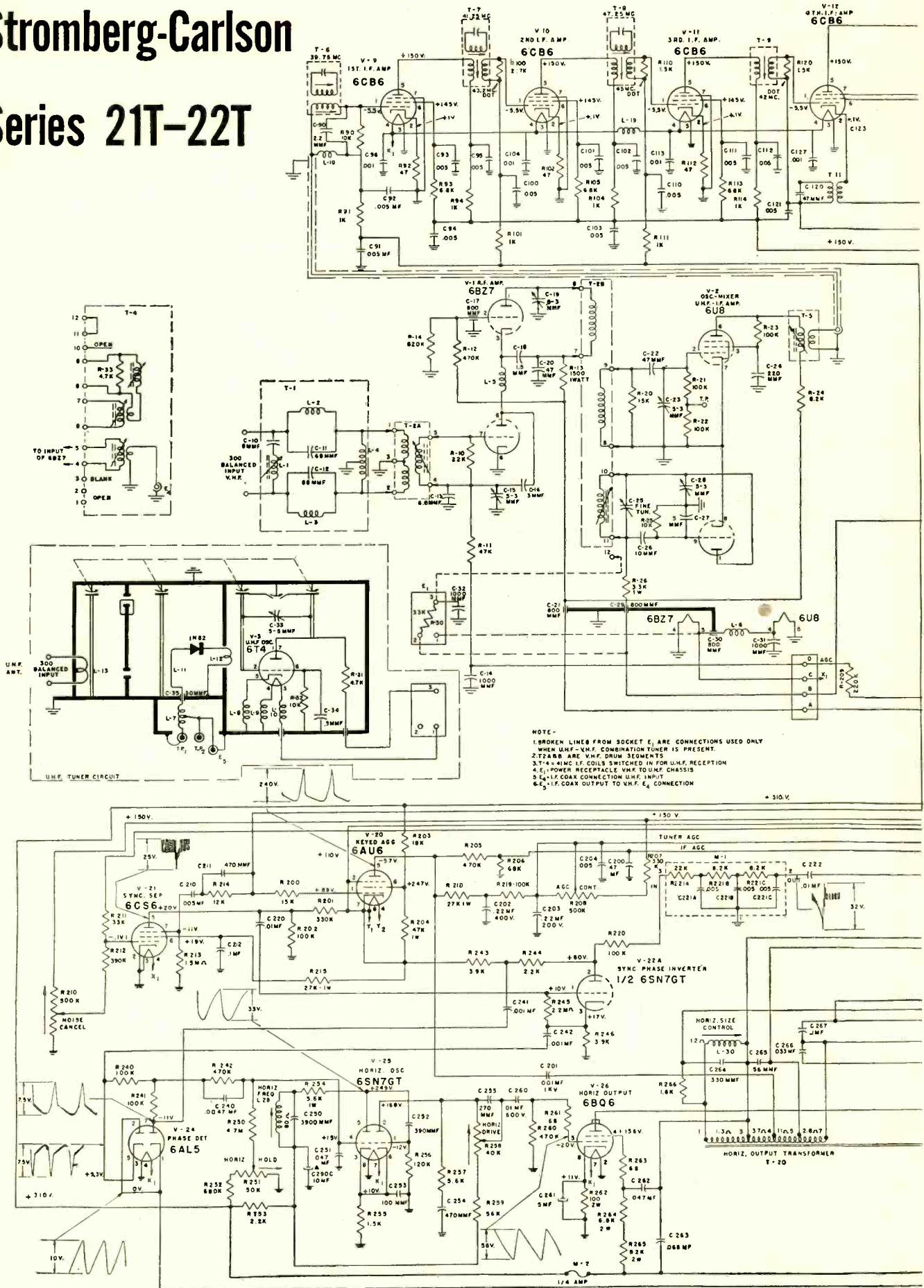

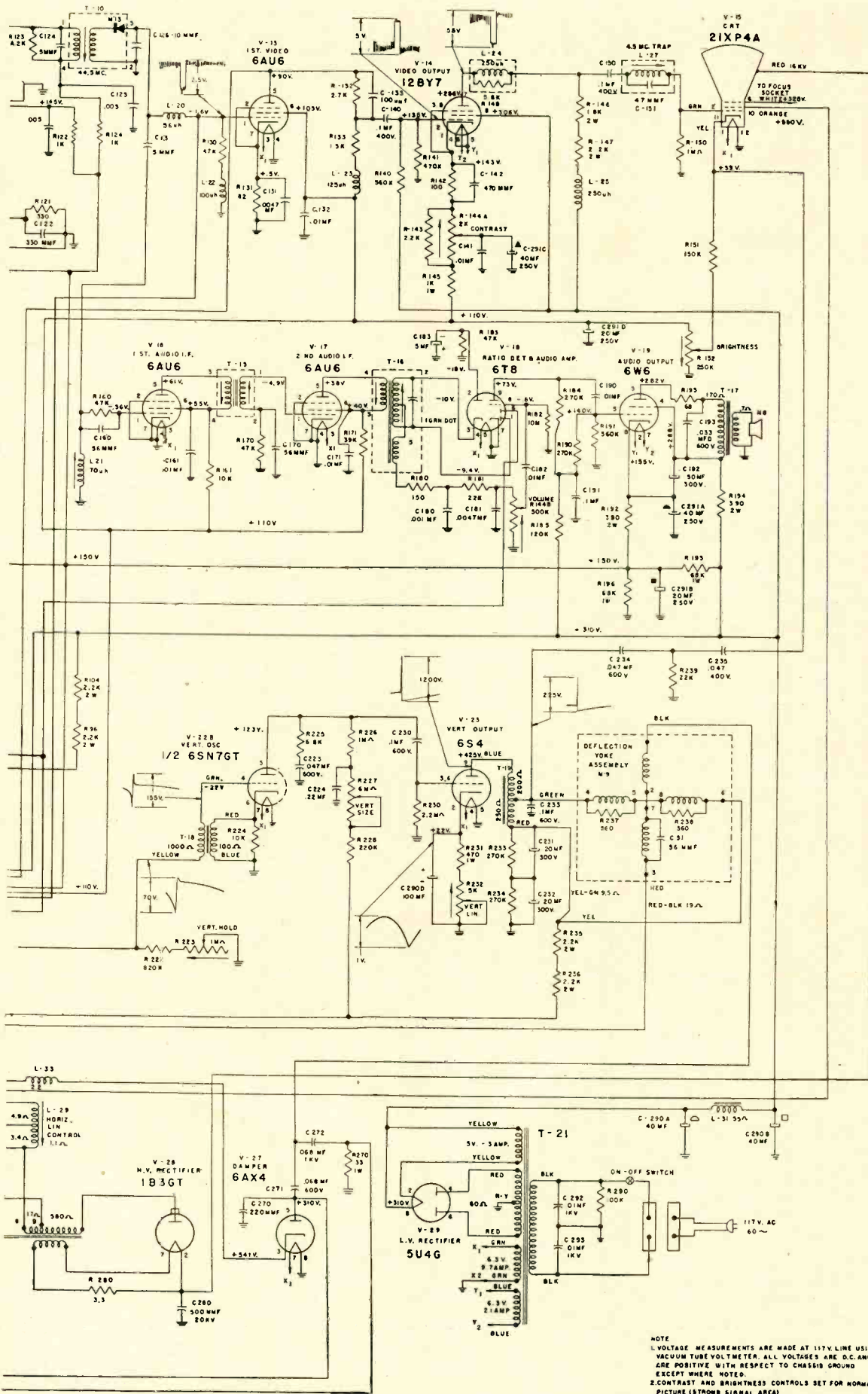

NOTE
 L VOLTAGE MEASUREMENTS ARE MADE AT 117V LINE USING
 VACUUM TUBE VOLTMETER. ALL VOLTAGES ARE D.C. AND
 ARE POSITIVE WITH RESPECT TO CHASSIS GROUND
 EXCEPT WHERE NOTED.
 CONTRAST AND BRIGHTNESS CONTROLS SET FOR NORMAL
 PICTURE (STRONG SIGNAL AREA)

RCA Models 21-S-348KU to 21-S-369KU

CHASSIS KCS88F and KCS88H.

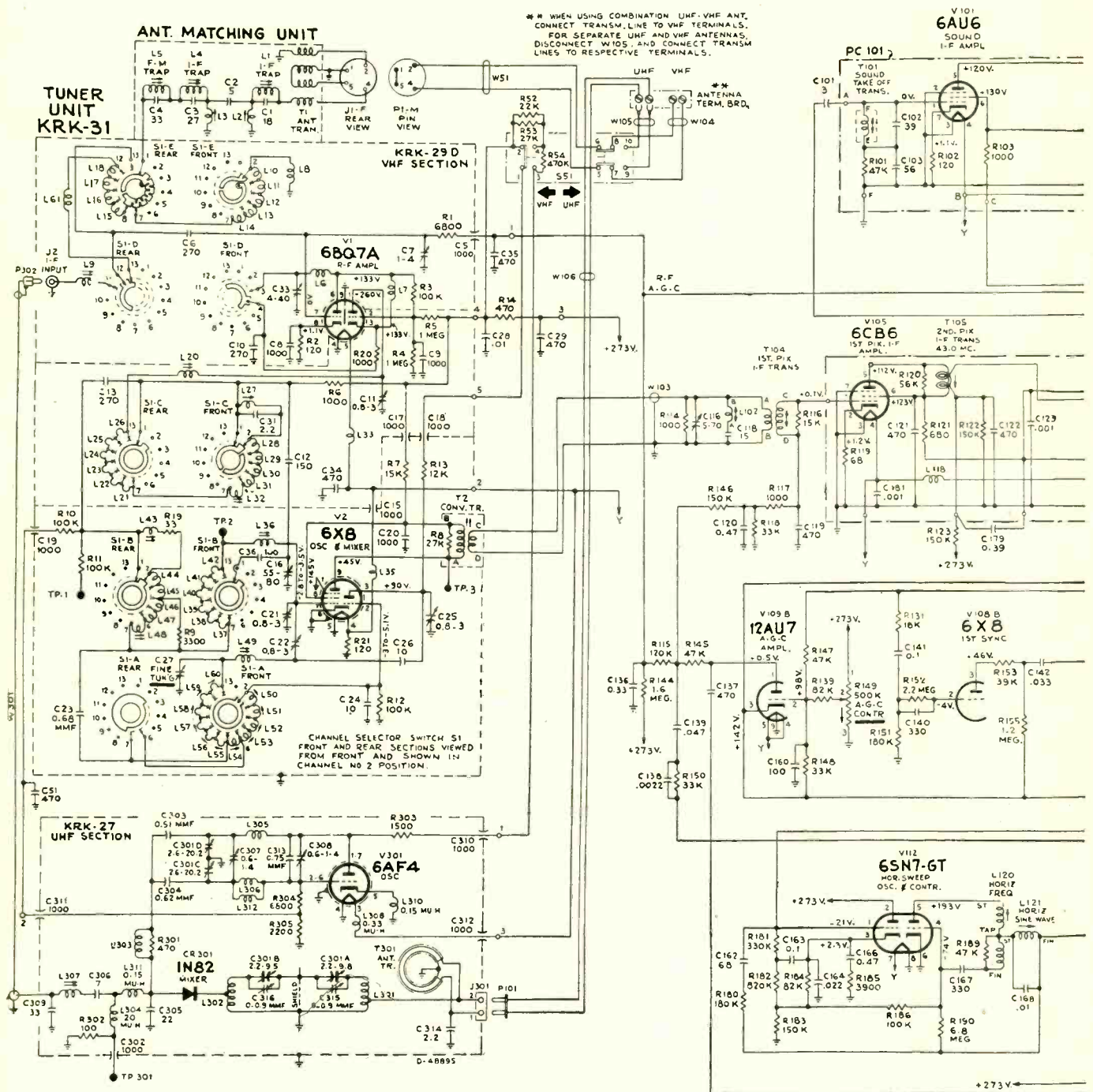

All resistance values in ohms. K= 1000

Direction of arrows at controls indicates clockwise rotation.

All voltages measured with Volt-Ohmyst and with no signal input. Voltages should hold within $\pm 20\%$ with a 117-volt a.c. supply.

TV r.f. range:

- 70 u.h.f. channels—470-890 mc.
- 12 v.h.f. channels—54-88 mc,
- 174-216 mc.

Front and rear sections of switch S101 viewed from front with switch shaft in extreme counter-clockwise position No. 1.

- Pos. 1—TV Min. Highs 4—Phono. Min. Highs
- 2—TV Normal 5—Phono. Normal
- 3—TV Min. Lows 6—Phono. Min. Lows

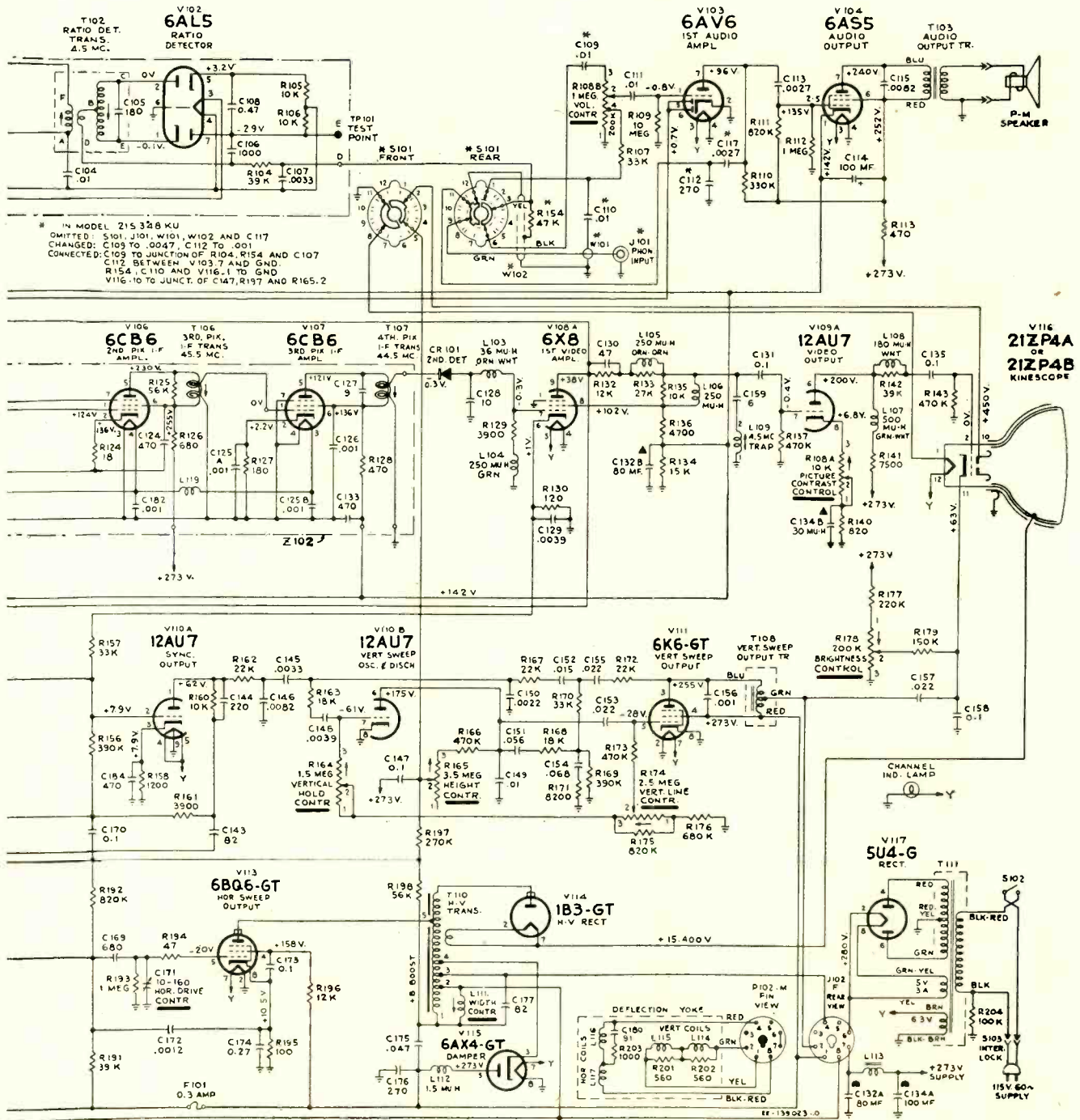

* Chassis KCS88H is identical to chassis 88F except as noted on diagram.

Picture i.f. carrier—45.75 mc.
Sound i.f. carrier—41-25 mc.

Sylvania 1-518-1, -2, -3 (TV Chassis C03)

- ☐ MEASURED WITH AN ELECTROSTATIC OR ZERO CURRENT METER AND AT LINE VOLTAGE METER READING OF 117 VOLTS, UNDER CONDITIONS OF NORMAL SIGNAL AND NO BRIGHTNESS.
- ☑ AGC CONTROL AT MAXIMUM COUNTERCLOCKWISE POSITION.
- * PICTURE CONTRAST CONTROL AT MINIMUM.
- ◇ BRIGHTNESS CONTROL AT MAXIMUM.
- ▲ HIGH PEAK VOLTAGE OF SHORT DURATION (APPROX. 5,000V) MAY DAMAGE METER USED FOR THIS MEASUREMENT.
- ◆ HIGH PEAK VOLTAGE (MORE THAN 1,000 VOLTS)

VOLTAGE SOURCES ARE INDICATED BY ENCIRCLED SYMBOLS. CORRESPONDING SYMBOLS WITHOUT CIRCLES INDICATE VOLTAGE SOURCE TIE POINTS. VOLTAGES ARE MEASURED TO CHASSIS UNLESS OTHERWISE INDICATED, D.C. TAKEN AT 20,000 OHMS PER VOLT, A.C. AT 1,000 OHMS PER VOLT. MEASUREMENT CONDITIONS, UNLESS OTHERWISE NOTED: SOURCE 117 VOLT 60 CYCLE, ANTENNA DISCONNECTED WITH NO SIGNAL INPUT, PICTURE CONTRAST AT MAXIMUM, BRIGHTNESS AT MINIMUM - OTHER CONTROLS AT NORMAL POSITIONS. AVERAGE VOLTAGES AND COIL RESISTANCES ARE INDICATED. RESISTANCE OF TAPPED COILS IS FOR ENTIRE WINDING. COIL RESISTANCE IS NOT SHOWN WHERE READINGS ARE TOO SMALL OR WIDELY VARIABLE. ARROWS AT CONTROLS INDICATE CLOCKWISE ROTATION.

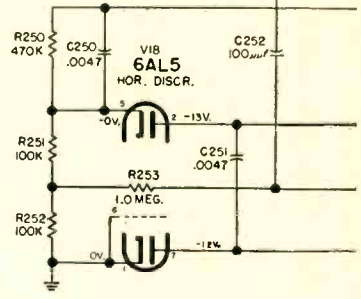
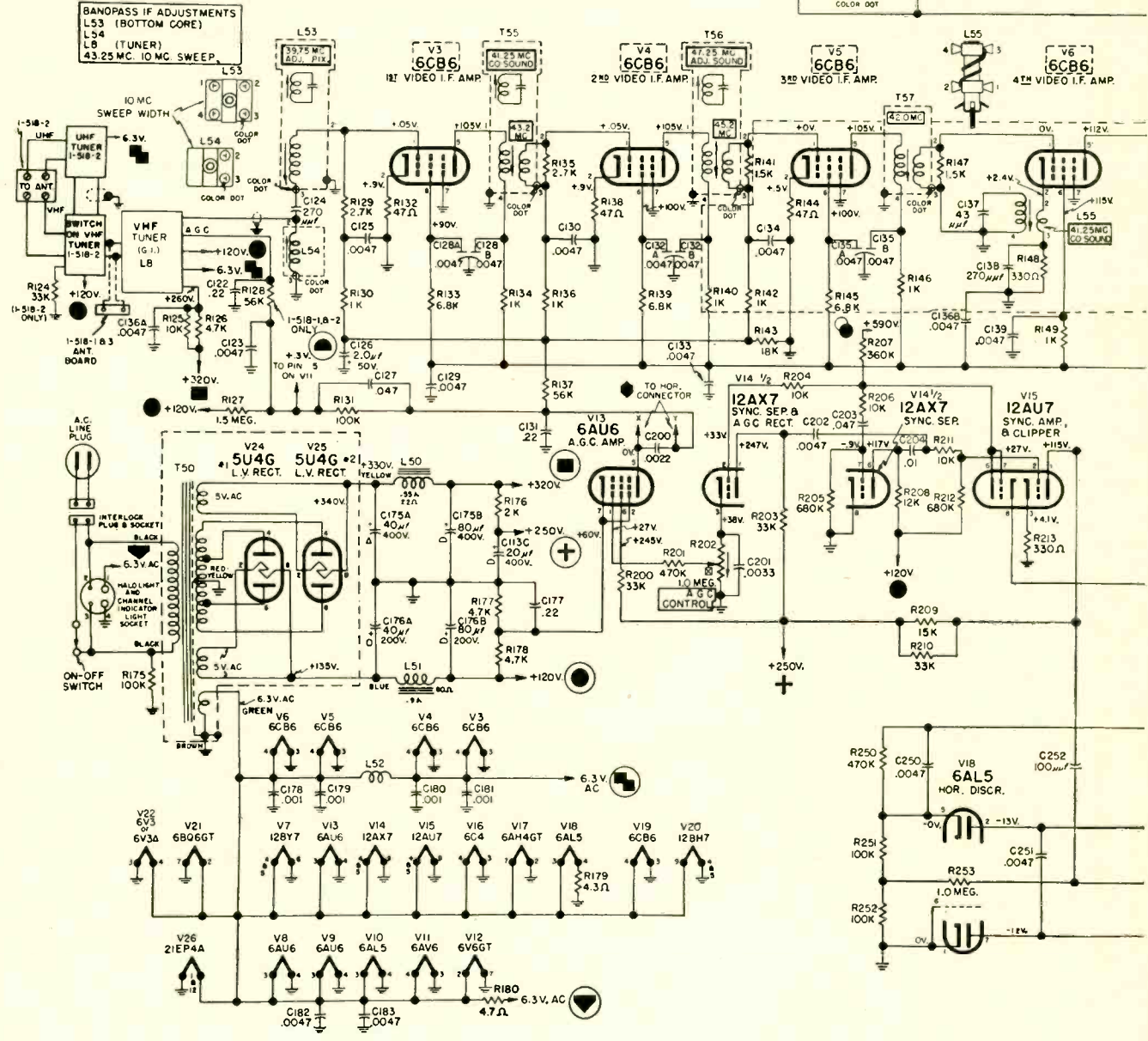
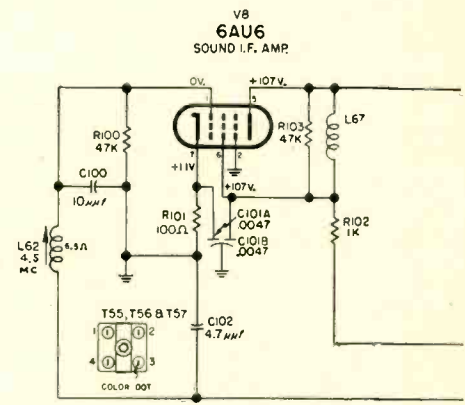

Caution: The high-voltage lead to the picture tube has a potential of 17,000 volts. Observe precautions when the chassis is out of the cabinet for servicing!

Do not operate the receiver with the high-voltage cover removed!
Always use safety goggles and gloves when handling the picture tube.

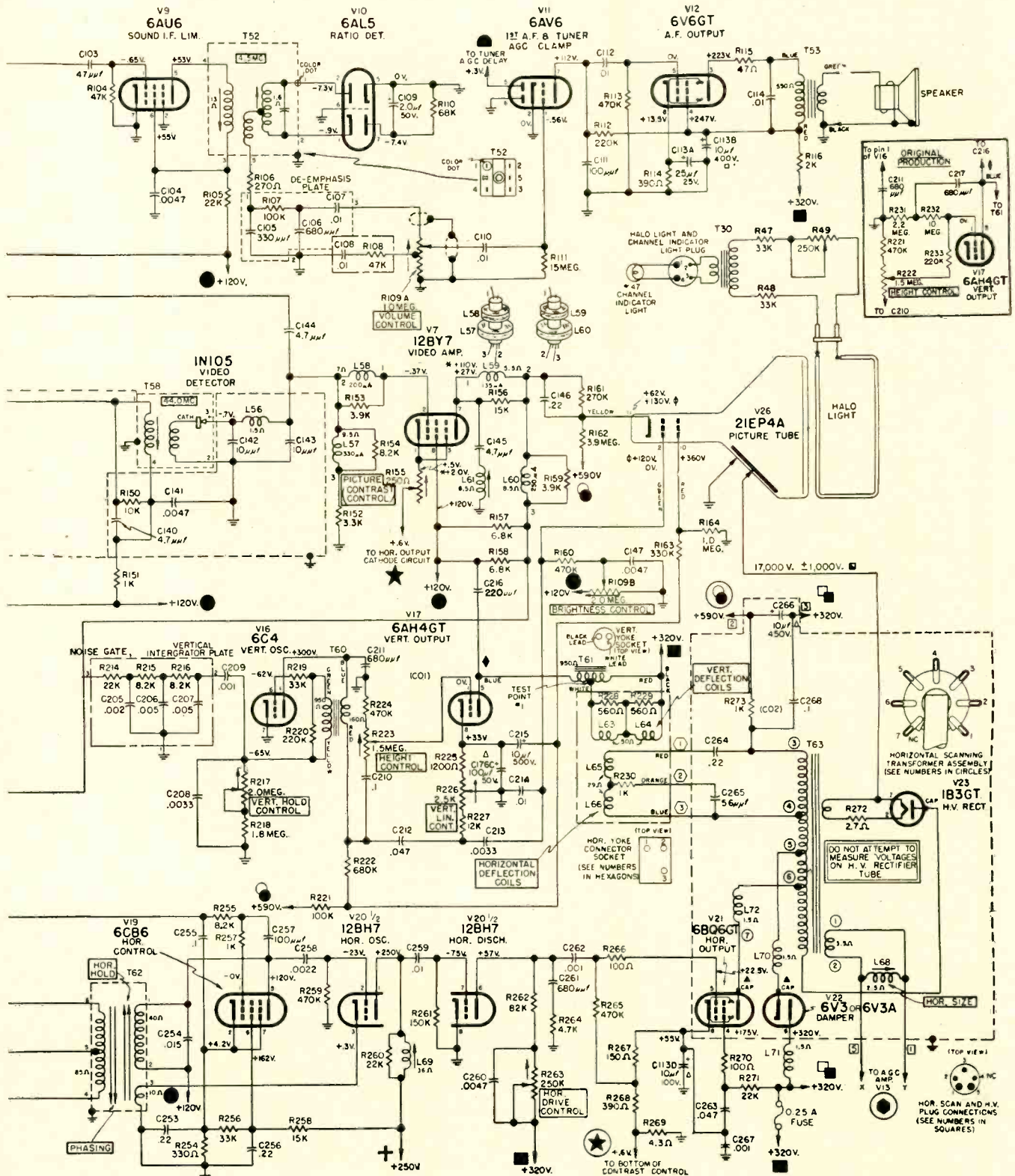



Fig. 1—Front panel view of generator.

CROSS-DOT LINEARITY PATTERN GENERATOR

By DAN LERNER and WINSTON STARKS*

A CHOICE of dot or bar patterns for adjustment of color or black-and-white television sweep circuits is provided by this instrument.

The linearity pattern generator is fast becoming one of the most useful pieces of test equipment in the television service shop. It permits accurate setting of the television sweep-circuit controls and may be used to preset the controls in the shop or make the final touch-up in the home. While not advertised as applicable to color TV work, the authors have successfully used this instrument for color convergence adjustments of the tri-gun type color kinescope.

Linearity pattern generators come in various types and sizes. Some are called *bar generators* and produce only vertical and horizontal bars. Others are known as *cross-hatch* generators and produce vertical and horizontal bars simultaneously. This type of pattern is usually imperfect and unstable unless standard sync pedestals and pulses of 60 cycles and 15,750 kc are also provided. This would make the instrument too expensive for anything but laboratory use. If the cross-hatch pattern can be made stable it becomes the most useful pattern because it allows adjustment of both vertical and horizontal sweep-circuit controls with the same pattern.

A third type of linearity pattern is the *cross-dot*. The Philco model G8004, shown in Fig. 1, produces the cross-dot pattern illustrated in Fig. 2. This type of pattern provides all the advantages of the cross-hatch and permits better synchronization and stabilization with simple circuits. The pattern contains horizontal black lines or bars which permit the adjustment of vertical deflection controls. It also includes verti-

cal rows of *dots* which take the place of vertical lines and permit the adjustment of horizontal deflection controls.

An additional advantage of the cross-dot pattern is that the dots are useful in checking special performance factors of the television receiver, including such items as focus, astigmatism, and high-voltage regulation effect on focus and blooming.

Circuit description

The model G8004 cross-dot generator produces an r.f. signal continuously tunable from channels 2 through 6. The r.f. signal can be modulated with a video pattern of any one of four types: (1) The cross-dot pattern shown in Fig. 2. (2) The horizontal bar pattern of Fig. 3. (3) The narrow, black vertical line pattern of Fig. 4. (4) The narrow white vertical line pattern of Fig. 5.

Fig. 6 shows the circuit diagram of the cross-dot generator. The heart of this circuit is a dual-triode 12AU7. The r.f. generator section uses one half of the 12AU7 (V1-b) as an r.f. oscillator, the frequency being controlled by C5-T2 in the grid circuit. Cathode feedback is used, and the r.f. output is taken from the plate circuit.

The other half of the tube, V1-a, operates as a pulse generator and modulator. With the function switch in either the left-hand or center position, this section of the tube operates as an L-C oscillator at about 189 kc when adjusted to produce 12 vertical lines on the television screen. The 189 kc figure was obtained by multiplying the 12 vertical lines by the horizontal sweep rate of 15,750 kc.

When the function switch is placed in the right-hand, or cross-dot position, the grid time-constant of the modulator is made very long. This fact, plus the unique design of the modulator transformer T3, results in a modified block-

ing-oscillator action. The frequency of the blockage is adjusted by the horizontal line DOT CONTROL, a 5-meg-ohm potentiometer used to control the grid time-constant. The blocking oscillator generates sharp pulses which, after clipping and shaping, are used to produce the horizontal bars in the pattern. When the horizontal line control is adjusted to produce an 8-line pattern, the frequency of the blocking oscillator is about 480 cycles. The 8-cycle figure is obtained by multiplying the number of horizontal bars on the TV screen by the vertical sweep rate (assumed to be adjusted to 60 cycles).

The unique feature of the circuit is the innovation by which the blocking action is made to produce rows of white dots superimposed upon the black bars.

The L-C circuit of the modulator, consisting of T3, C3, and C4, is shock-excited by the pulses produced by the blocking-oscillator action. Because the L-C circuit was pretuned to produce the vertical lines for the left-hand and center FUNCTION SWITCH positions, shock excitation of this circuit produces a ringing or damped oscillations at the same frequency. The coil will not ring long enough to produce a vertical line but will produce a white dot at the point on the television raster where we would imagine the vertical line to cross the horizontal black line. (See Fig. 2)

The damped oscillations, produced in the grid L-C circuit, are shaped by damping, differentiation, and clipping. The phase and frequency of the pulses which form the dots is controlled by the VERTICAL LINES control C4. Since C4 adjusts the phase and frequency of the dots, it also controls their stability or synchronization on the TV screen. Although the same synchronization effect can be had by adjustment of the horizontal hold control of the TV receiver, this method would cause a change in

*Test Equipment Section, Philco Corp.

the sweep frequency of the receiver.

An interesting feature of the cross-dot circuit is that the production of the dot pattern by excitation from the horizontal line pattern makes it easier to lock the vertical dot rows in step with the horizontal lines.

The clipper crystal D1 and the associated R-C circuit elements shape the various modulation pulses to provide sharper lines and dots. The modulation pulses and the r.f. signal are combined in the modulator crystal D2.

Since the generator does not produce standard vertical and horizontal sync pulses, it sometimes is difficult to obtain a stable pattern. The normal power-supply hum in a TV receiver is usually sufficient to cause pronounced *weave* in the pattern produced by any service linearity generator. The circuit has a built-in stabilization system designed to pick up sweep-frequency pulses radiated from the TV receiver into the power line. Capacitors C1 and C2 pass these pulses to the grid of the modulator to aid in stabilization. Whenever still better stabilization is needed, the EXT. SYNC jack may be connected to a wire which is simply wrapped one or two times around the yoke cable. (CAUTION: An actual connection to the yoke cable wires should never be made because of the very high pulse voltages on these wires.)

Vertical linearity

To adjust the vertical linearity of a television receiver, the r.f. output from the generator is fed into the antenna circuit, and the vertical hold control of the receiver is adjusted for the 60-cycle sweep rate (normal setting). The pattern is then synchronized by the line controls on the generator. The horizontal-line control of the generator is adjusted to give about 8 horizontal bars on the screen. Vertical linearity of the TV set is then adjusted by the height and vertical linearity controls. These two controls are adjusted to give a full raster with the horizontal bars equally spaced over the entire raster as shown in Fig. 2.

Picture height

Using the same setup as in the preceding paragraph, both the height and vertical linearity controls of the TV receiver should be adjusted so that the vertical linearity is maintained as the total vertical deflection is varied. The vertical size of the pattern (vertical sweep) may be adjusted by simply setting the raster height so as to overscan approximately $\frac{1}{2}$ to 1 bar space at both the top and bottom, assuming a total of 8 bars. The overscan is to allow for the blanking on the test pattern or program as transmitted by television stations. Maintain linearity in accordance with the procedure given in the preceding paragraph.

Horizontal linearity

The function switch on the cross-dot generator may be in any position for

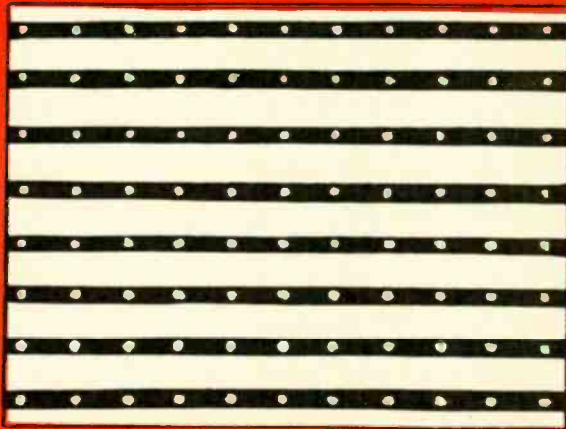

Fig. 2—Cross-dot pattern. Function switch is in right-hand position.



Fig. 3—A horizontal bar pattern.

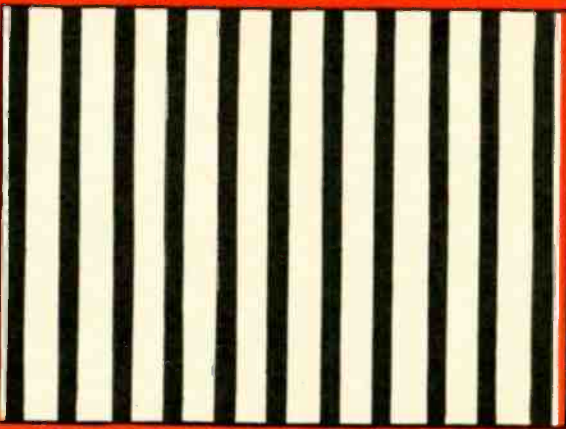

Fig. 4—Black vertical lines pattern.

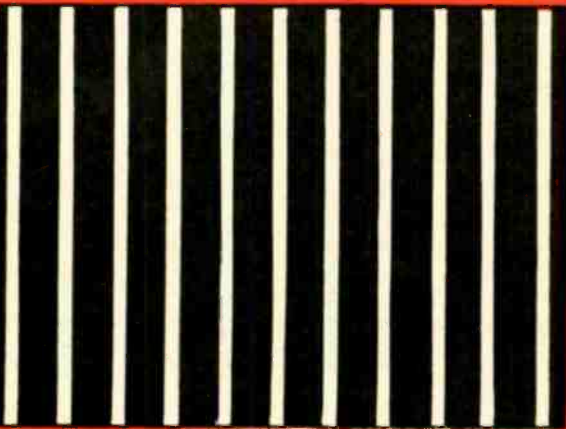

Fig. 5—White vertical lines pattern.

TEST INSTRUMENTS

the adjustment of horizontal linearity. Horizontal linearity is judged by observing the distance between the vertical bars (or the horizontal spacing of dots). If the bars or dots are equally spaced all the way across the raster (horizontally), the horizontal linearity may be considered satisfactory. However, if they are not, the horizontal linearity control of the TV receiver should be adjusted to obtain the best spacing possible. Some sets do not have a horizontal linearity control. If linearity appears unusually poor, check for circuit or tube defects. It should be kept in mind that the horizontal grid drive control (some sets do not have one) also affects linearity. Usually this control is set for the most high voltage (brightest picture and most sweep width). If this adjustment produces excessive Barkhausen lines, the grid drive may have to be reduced, giving a slight loss of brightness.

Where a numerical figure for linearity (vertical or horizontal) is desired, it is common practice to calculate it as follows:

$$\% \text{ nonlinearity} = \frac{D1 - D2}{D2} \times 100$$

where D1 is the distance between two adjacent lines with greatest spacing, and D2 is the distance between two adjacent lines with closest spacing.

A figure of 20% is not at all uncommon, but 10% or better is desirable. It is not unusual to have a squeezing together at the edges of the raster. In most cases this is accepted as normal if it does not give a linearity figure of more than 20%. Since it is common practice to make a raster overscan to take care of blanking and the effects of line voltage changes, the edge squeezing is at least partially hidden.

Horizontal width

The reaction between the width and horizontal linearity controls usually is not excessive. Therefore, with the generator set up for about 12 vertical lines, it will normally be sufficient to adjust only the width control to give an overscan of about one line or one dot space on each side of the raster.

Leveling and centering

The picture can be leveled by rotating the yoke to make the horizontal lines

level with respect to the edges of the picture-tube mask. This adjustment is best made when a large number of horizontal lines are in the pattern. The horizontal line control of the generator may be turned to give the maximum number of lines.

CAUTION: Avoid touching the yoke with the hands while the receiver is in operation, since very high voltage pulses are present on the yoke coils. To adjust yoke with the set in operation, an insulated rod or similar tool should be used. When tightening the yoke after it has been adjusted, keep the yoke all the way forward with the insulated tool. This is to reduce the possibility of shadow at the corners and edges of the raster.

Picture centering is accomplished by adjusting the centering control until the overscan is the same at the top and bottom of the screen. Likewise, the overscan should be made the same on the right as it is on the left. If a shadow is now visible on the edge of the pattern, the setting of the beam bender should be checked. Yoke positioning also may be at fault. A defective horizontal circuit or defective yoke can also cause this trouble. A slight readjustment of centering can sometimes clear up shadow, but should not result in excessive decentering of the raster. If none of these adjustments help, the high voltage and circuit operation should be checked.

NOTE: Most television deflection and picture-tube assembly adjustments have some interaction. Where this effect is apparent when a particular adjustment is performed, a readjustment of the other controls affected should be made. In particular, it will be found that there is an interaction between yoke adjustments, centering, beam bender, and horizontal and high-voltage controls.

Beam bender and focus

After making the above adjustments, the beam bender will usually need readjustment. A misadjusted beam bender can result in serious damage to the picture-tube gun or screen.

The cross-dot pattern is ideally suited for making focus adjustments. With this pattern on the screen, the TV contrast control should be set to a medium level and the brightness (or back-

ground) control is adjusted for normal brightness. The focus control is then adjusted for sharp lines and dots. It should be possible to see the sweep lines of the raster and the dots in sharp focus over the entire screen. If the television receiver does not have a cosine yoke it probably will not be possible to obtain sharp focus over the entire screen. In this case it will be necessary to compromise on the focus.

After the focus adjustments have been made, a check on defocusing and high-voltage regulation may be made by watching dots and sweep lines as the brightness and contrast controls on the television receiver are varied from minimum to maximum. Some defocusing is normal when both of these controls are set to maximum.

Circuit hum

Excessive hum in the circuits of a television receiver may cause poor sync or bending of parts of the picture. Also, on programs transmitted from relatively distant points, the residual hum in the receiver power supply may be out of step with the transmitted 60-cycle sweep, and the hum distortion will appear to drift through the picture. This effect is called *picture weave*. A horizontal shifting or weaving results from hum in the horizontal circuits. A shift in both directions simultaneously gives a circular motion to components of the picture. These effects are more apparent and more easily detected if a cross-dot pattern is viewed on the receiver screen. An extremely well-filtered power supply is used in the cross-dot linearity generator, so that any hum effects appearing on the TV receiver screen will be due to the hum originating in the receiver.

Generator alignment

Alignment of the model G8004 is simple and straightforward. The r.f. oscillator is aligned by first setting the channel dial pointer on the channel 2 mark and then adjusting the oscillator coil core to produce the strongest and clearest cross-dot pattern on a properly adjusted television receiver, also set to channel 2. Another method would be to use a grid-dip meter set at approximately 58 mc to peak the r.f. oscillator coil for channel 2 setting.

The modulator coil is usually adjusted to produce 12 vertical lines when the vertical-line control is set midway in its range. If a different number of lines is desired, the adjustment can be made with a screwdriver inserted through the hole provided in the rear of the generator housing.

If the modulator coil is adjusted when the cross-dot pattern is being used, a change in adjustment not only will vary the spacing and number of vertical dot rows, but also will pull the number of horizontal lines along with the change, thereby tending to maintain the same proportion between the number of vertical dot rows and the number of horizontal lines.

END

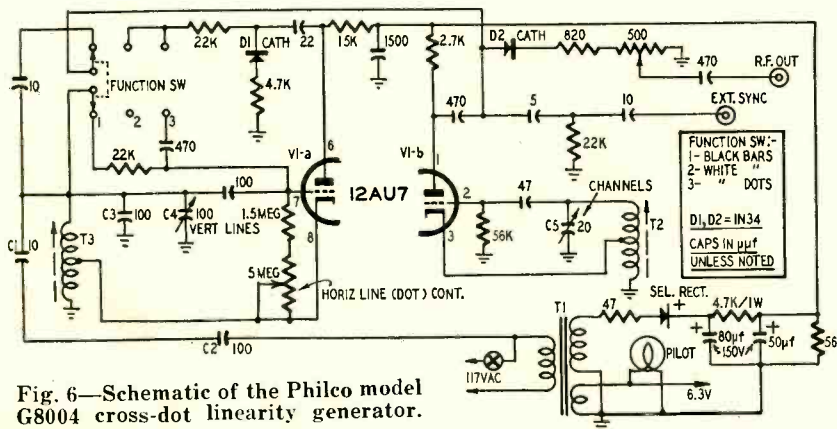

Fig. 6—Schematic of the Philco model G8004 cross-dot linearity generator.

Fig. 1—Sweep-linearity patterns.



new instruments for better servicing

Some recently developed test equipment for the radio and TV service technician

By Robert F. Scott
TECHNICAL EDITOR

DURING the past several months a number of new and revolutionary radio and TV test instruments have been developed and many improvements have been made in basic test instruments such as multimeters, tube testers, v.t.v.m.'s, and signal generators. It is my belief that a technician's ability to do an effective job is determined directly by the efficiency of his test instruments and his knowledge of their applications and limitations. I have studied the features of some of the latest developments, and in this article I will review the circuits of new capacitor and flyback transformer testers and the design features of a new v.h.f.-u.h.f. signal generator that uses an Inductuner as its tuning element.

Do-All TV signal generator

The Radio City model 750 TV signal generator combines the functions of AM signal, linearity pattern, and marker generators to justify its being called the *Do-All* generator. It is one of the most versatile instruments of its type currently available to service technicians. It covers all FM and TV intermediate frequencies and v.h.f. signal frequencies in three fundamental ranges: 9 to 11, 21 to 47, and 54 to 200 megacycles. On the fourth and fifth ranges, used for u.h.f., the third and fourth harmonics of a band of frequencies between 155 and 230 mc are used to cover from 465 to 690 mc and 620 to 900 mc.

Internal modulation frequencies of 360 cycles and 141.75 kc may be applied separately to produce horizontal or vertical bars or used simultaneously to check sweep linearity. The linearity patterns obtainable with this instru-

ment are shown in Fig. 1. The internal modulation frequencies are available at a separate output jack for testing audio and video amplifiers.

Performance

Checking the dial calibrations of the first three ranges against a BC-221 heterodyne frequency meter and an assortment of accurate crystals, I found the instrument unusually accurate for one of its type. In checking at least three points on each fundamental range, the calibration accuracy was found to be well within the 0.1% limits specified by the manufacturer for the 9-11-mc band and less than the 0.5% tolerance specified for the remaining bands. These checks were made after a 30-minute warmup period. With a cold start, the instrument drifts for about 3 minutes and then settles down on frequency.

Circuit of the 750

The complete *Do-All* generator is shown in Fig. 2. The r.f. tuning element is a 2-section Mallory spiral-type Inductuner. One section is connected across r.f. oscillator V2-a for the 9-11- and 21-47-mc bands; the other section is connected across V2-b for the bands covering from 54 to 900 mc.

Either section of V2 may be modulated by 360 cycles and 141.75 kc. The modulation signals are applied across a 10,000-ohm resistor (R9) common to the grid returns of V2-a and V2-b. The output of the r.f. oscillator is developed across the 91-ohm cathode resistor R8, common to both sections. The signal voltage is tapped off this resistor and applied to the 200-ohm

OUTPUT CONTROL.

The Fig. 3 diagrams show the basic

r.f. oscillator circuits for the various ranges. On band A (9 to 11 mc) coils L2 and L3 are connected in series with variable inductor L1, a part of the Inductuner, to limit the minimum inductance in the circuit of V2-a when L1 is shorted out. The circuit capacitance consists of C3, C4, C5, C6, C7, and C8 connected as in Fig. 3-a. The circuit tunes from 9 mc with L1 fully in the circuit to 11 mc with L1 shorted out.

On band B, the 21-47-mc range, L3 and capacitors C3, C4, and C5 are disconnected so the circuit of V2-b appears as in Fig. 3-b. On bands A and B, plate voltage is applied to V2-a through 1,000- and 5,100-ohm resistors to the center-tap on L2.

Band C, 54-220-mc, is covered by the basic range of the Inductuner section L4, connected between grid and plate of V2-b. The tuned circuit consists of series coil L5 and variable inductor L4 in series and shunted by a 3-12- μ f trimmer C12. The inductance of L5 establishes the highest frequency, and the setting of the trimmer establishes the low-frequency calibration point. B plus voltage is applied to the junction of L4 and L5 through a 10,000-ohm series resistor. The circuit configuration is shown in Fig. 3-c.

Bands D and D' are limited to a tunable range of 155 to 230 mc by a band-spread arrangement obtained by connecting shunt coil L7 across variable inductor L4 (see Fig. 3-d). With L7 shunting L4, the effective inductance in series with L5 is reduced, thus raising the low-frequency limit of the range. L5 and the trimmer capacitor determine the high-frequency end of the range with L4 shorted out. The third harmonic of this 155-to-230-mc

TEST INSTRUMENTS

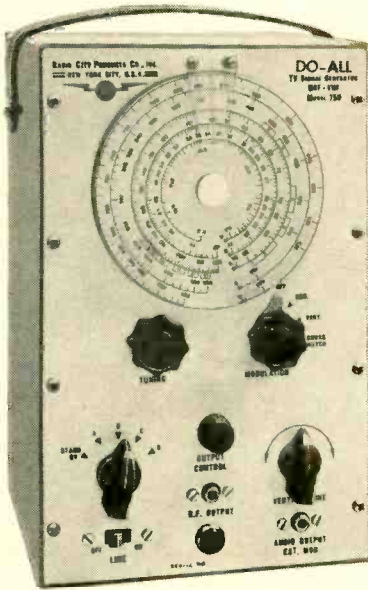

Versatile u.h.f.-v.h.f. signal generator.

range is used to cover from 465 to 690 mc, and the fourth harmonic is used between 620 and 900 mc.

Internal modulation is supplied by oscillator V1 (Fig. 2). Section V1-a is tuned to approximately 360 cycles to produce six horizontal bars on the TV screen. V1-b produces vertical bars. Its frequency is adjustable over a narrow range so it can be adjusted to precisely 141.75 kc. At this frequency, the TV set will sync with the pulses at the output of the generator. The frequency of V1-b is varied by the VERTICAL LINE control.

The B plus lines to the plates of V1-a and V1-b are controlled by S2, the MODULATION switch. When set to OFF, the B supply is disconnected from both sections of V1. If external modulation is desired, the modulating signal can then be applied to the r.f. oscillator through the AUDIO OUTPUT-EXT. MOD. jack.

The HOR. position of S2 applies B plus voltage to V1-a; the VERT. position

applies plate voltage to V1-b; and the CROSSHATCH position turns on both sections of V1 to produce the checkerboard test pattern on the TV screen. The outputs of V1-a and V1-b are taken from their respective plate circuits and applied across the R9 in the grid circuits of the r.f. oscillators.

Flyback transformer tester

The Kirby model 68 flyback tester is one of the most recent test instruments developed to minimize second-guessing by the service technician. Designed especially to test flyback transformers for shorts, open circuits, and intermittents, it can be used also for similar tests on audio, power, and vertical output transformers, and r.f. chokes with inductances above 10-20 millihenries.

The tester in Fig. 4 is essentially a 1,500-cycle triode oscillator. Raw a.c. on the plate keys the oscillations on and off at a 60-cycle rate. The keying transients thus produced are useful in causing a permanent breakdown in intermittent open or short circuits. The strength of oscillations is indicated by a 20,000-ohms-per-volt meter across the grid resistor. Meter sensitivity is controlled by the 2-megohm CALIBRATE control.

In most instances, flyback transformers can be checked without being removed from the TV set. Continuity tests are made by connecting test leads across adjacent terminals on each winding of the transformer. If the circuit is unbroken, it shorts out the oscillator grid voltage and the meter reads in the GOOD portion of the bottom scale.

Short tests are made by connecting the transformer primary directly across the primary of the tester oscillator coil. The test leads connect across the high-voltage section of the primary on 70° to 90° transformers and across the full primary (B plus and rectifier plate terminals) on transformers of less than 70°. The inherent inductance of direct-drive and air-core flyback transformers is too low for reliable tests, so the inductance is raised by removing the powdered-iron core from a defective transformer, breaking it in half, and inserting it in the air core of the transformer being tested.

One or more shorted turns in the primary or secondary of the transformer short-circuits the magnetic circuit and places an unusually heavy load on the oscillator. This lowers the efficiency of the circuit so the grid voltage drops and the meter reading falls to REPLACE on the center scale.

Most linearity and width coils can be checked for short and open circuits in the same way as transformers.

The Sprague Kwik-Test

The model KT-1 capacitor tester is a new test instrument designed to supplement the standard capacitor analyzer or bridge by testing capacitors from 30 μf to 2,000 μf for shorts, opens,

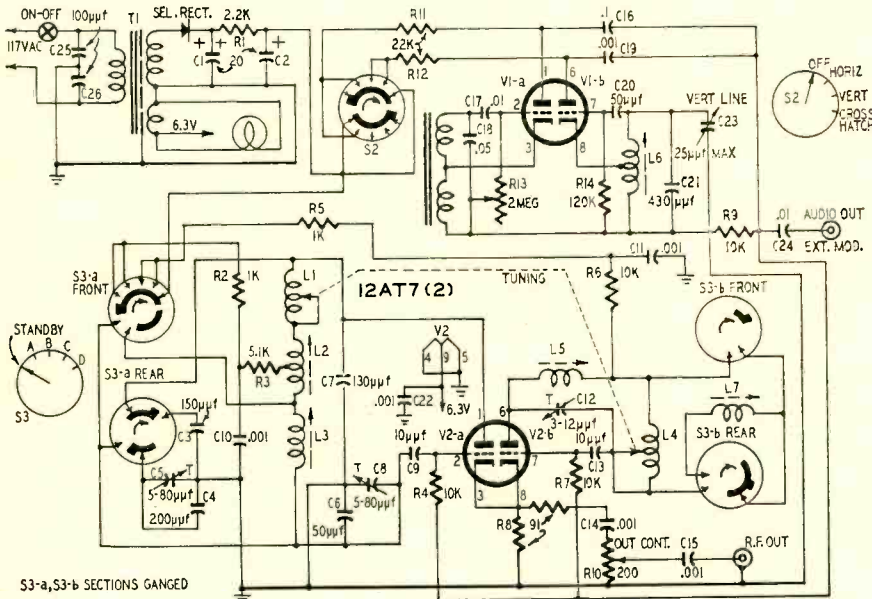

Fig. 2—Schematic of the Radio City model 750 Do-All signal generator.

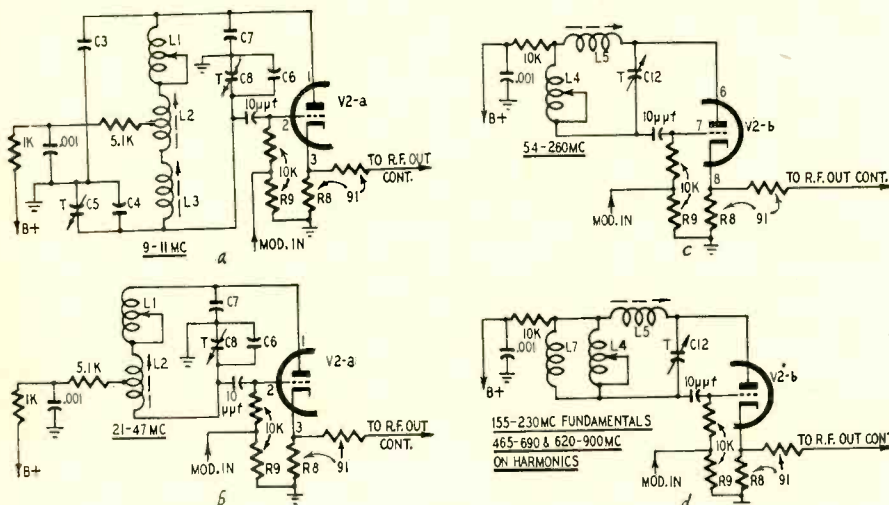
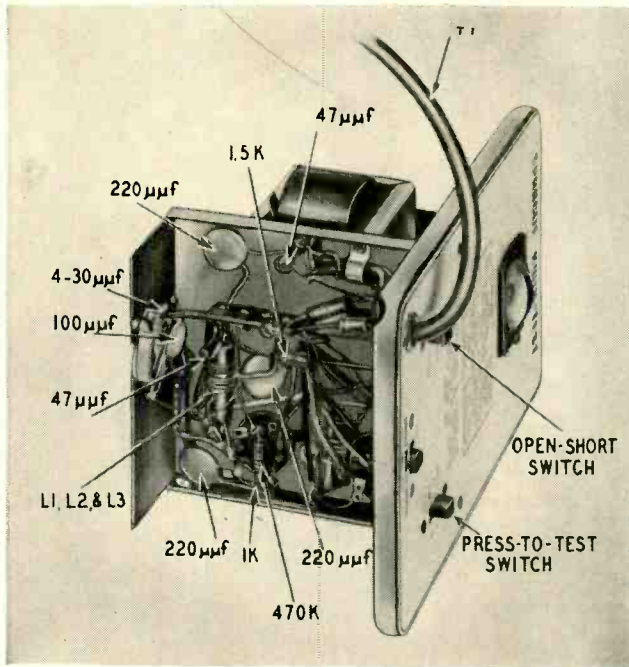
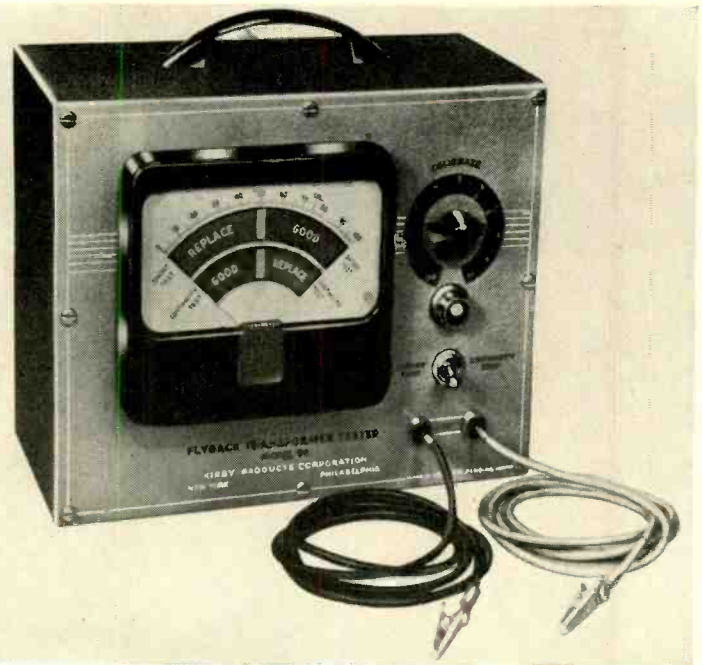

Fig. 3—The radio-frequency oscillator circuits for the various ranges.



Instrument tests capacitors from 30 μf to 2000 μf .



Unit tests wide range of horizontal flyback transformers.

and intermittents without disconnecting them from their associated circuits. These tests can be made even when the capacitor is shunted by a resistance as low as 60 ohms. In the range of 0.1 to 2,000 μf , capacitors can be checked for shorts when shunted by a resistance as low as 2 ohms.

The circuit of the KT-1 *Kwik-Test* is shown in Fig. 5. Tests are made with the apparatus turned off and the test leads clipped to the capacitor under test. When the OPEN-SHORT switch is set to SHORT a 60-cycle voltage is applied to the capacitor through a series circuit

consisting of a 30-ohm resistor and a 470,000-ohm resistor shunted by a 0.1- μf capacitor. When the TEST switch is pressed the capacitor is connected between ground and the grid of the 1629 electron-ray indicator tube. A shorted capacitor grounds the grid of the 1629 and the eye remains open. If the capacitor is not shorted, a part of the 60-cycle voltage biases the grid and causes the shadow angle to decrease. The amount of eye closure depends on the value of the capacitor and the circuit in parallel with it. A large capacitor shunted by a small resistance produces only a slight change in shadow angle. Intermittent shorts can be detected by tapping the capacitor.

Testing for open circuits

A 20-mc oscillator is used when checking capacitors for open circuits. Coils L1 and L3 form the oscillator circuit. L2 feeds power simultaneously to the grid of the indicator tube through a 1N51 germanium diode and to the test clips through a pi-section impedance-matching network Z1 and

a 48-inch length of RG-54/U coaxial line, T1.

The r.f. voltage applied to the diode is rectified to provide grid bias for the 1629 when the PRESS-TO-TEST switch is closed. The bias on the 1629 grid reduces the shadow angle (closes the eye) in proportion to its d.c. value. With zero voltage the eye is wide open; a low voltage causes a slight closing, and a high voltage closes the eye.

The 30- μf trimmer (C1) on the input side of Z1 is adjusted at the factory so the combination Z1-T1 represents a transmission line exactly one-quarter wavelength long (electrically) at 20-mc. The transmission line and the diode rectifier are paralleled across L2. A capacitor to be checked is connected between the clips at the load end of the transmission line. If the capacitor is open the impedance-reversing characteristics of the quarter-wavelength line will make it appear as a short circuit across L2. Under this condition, L2 will not deliver voltage to the 1N51, so the eye remains open when the PRESS-TO-TEST switch is operated.

The reactance of a good capacitor appears as an impedance between the clips. A small capacitor has a comparatively high reactance, so L2 sees a partial short, and the voltage delivered to the diode is low. The eye will then show only a small closing. A large capacitor causes a greater closing because its lower reactance appears as a higher impedance across L2 as it delivers a larger voltage. Good capacitors of 200 μf or larger close the eye completely. Smaller capacitors close the eye in proportion to their capacitance.

When testing for opens or shorts, closing of the eye, no matter how slight, when the test switch is operated indicates that the capacitor has passed that particular test.

END

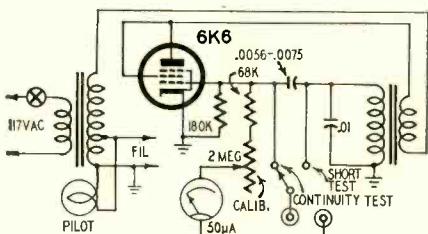

Fig. 4—Flyback transformer tester.

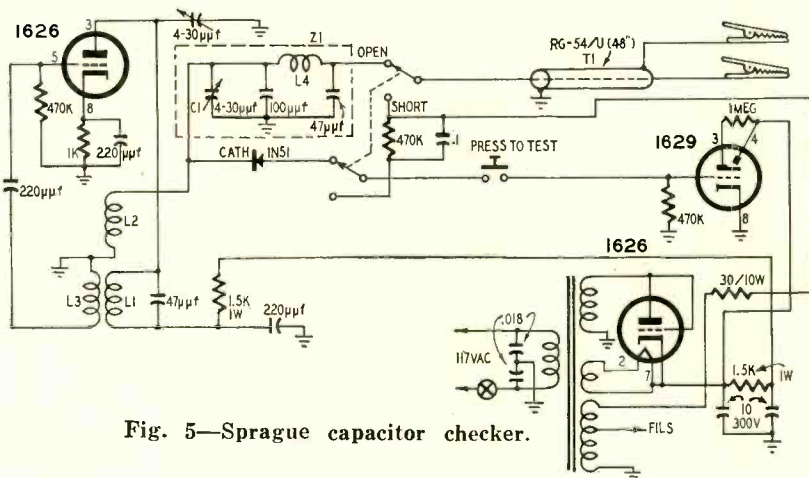

Fig. 5—Sprague capacitor checker.



Front view of the compact wide-range oscillator

COMPACT WIDE-RANGE OSCILLATOR

By RICHARD GRAHAM

As electronic equipment gets smaller and more complex, miniaturized test and service instruments become important. Increased circuit complexity means that more test equipment must be on the bench. The result is often bedlam and confusion, particularly with today's oversize test equipment.

Compact test equipment is often viewed with distrust for too often its small size has been obtained at the expense of performance. However, in the oscillator described, nothing is sacrificed to achieve compactness. While the unit measures only 6 inches on each side, the frequency range extends from 20 cycles to 2 megacycles. The output is a constant 5 volts \pm 0.5 db and has a distortion of only 0.25% through the audio range. Furthermore, to make duplication of the unit easy, no special selection or matching of resistors is necessary. Compactness is achieved mainly through the use of miniature tubes and careful placement of parts.

Circuit

The oscillator is basically the popular

bridged-T with a cathode-follower output stage (Fig. 1). The 6AU6 (V1) serves as a high-gain broad-band amplifier. The two 6AK6's following are both cathode-follower stages. Regeneration at all frequencies is provided by the cathode-to-cathode coupling between V1 and V2 through the 3-watt lamp. A degenerative path between the two stages is provided from the cathode of V2, through the bridged-T network to the grid of V1. The amount of degeneration between the two stages will vary with frequency for a particular set of R1-5, R6-10 and C1 values. This is illustrated in Fig. 2. The frequency of oscillation will then be at the frequency of minimum degeneration—i.e., the frequency at which the voltage fed back through the network is at a minimum.

By switching in five sets of resistors in the bridged-T network (R1 through R10) and varying C1 over each range, continuous oscillations are produced from 20 cycles to 2 megacycles. (Band A—20–300 cycles; Band B—250–3,000 cycles; Band C—2.1 kc–25 kc; Band D—22 kc–250 kc; Band E—250 kc–2 mc). Circuit adjustment and calibration is

greatly simplified by using regular 10% tolerance resistors in the bridged-T network. This makes it necessary to calibrate each frequency range individually to compensate for the resistor variations, but it eliminates tracking difficulties which would become evident on the higher frequency ranges. Needless to say, 10% tolerance resistors are a lot cheaper too.

The 3-watt lamp LM keeps the amplitude of the output constant by controlling the regenerative feedback current. The lamp resistance increases with the current being fed back, thus stabilizing the output.

The 100- μ f capacitor, C2, introduces some positive feedback peaking which boosts the output on the higher frequency range.

The output of the oscillator is taken from the cathode of V2 and fed into another cathode-follower stage, V3. This stage provides complete isolation between the oscillator and the output. The output is controlled by a log-taper potentiometer which permits an output adjustment down to the millivolt region, easily and accurately.

The power supply is a compact transformer-operated half-wave voltage doubler using selenium rectifiers. This supply has an output of 180 volts under load at the output of the two-section R-C filter.

Construction

The layout of the components both above and below chassis is shown in Fig. 3 and Fig. 4. As might be expected in any circuit in which the grid is 30 megohms above ground (on band A) and which has a large unshielded metallic mass (C1) connected to the grid, there can be a serious amount of hum pickup. The extent of this problem, if there is any at all, depends almost entirely on the parts layout. Since compactness necessitates arranging the components very close to each other, the possibility of hum pickup is greatly increased. A.c. pickup is not noticeable in this unit. However, in preliminary models the problem was severe. Thus the general layout shown is suggested.

If the constructor wants to change the layout to fit a cabinet and chassis

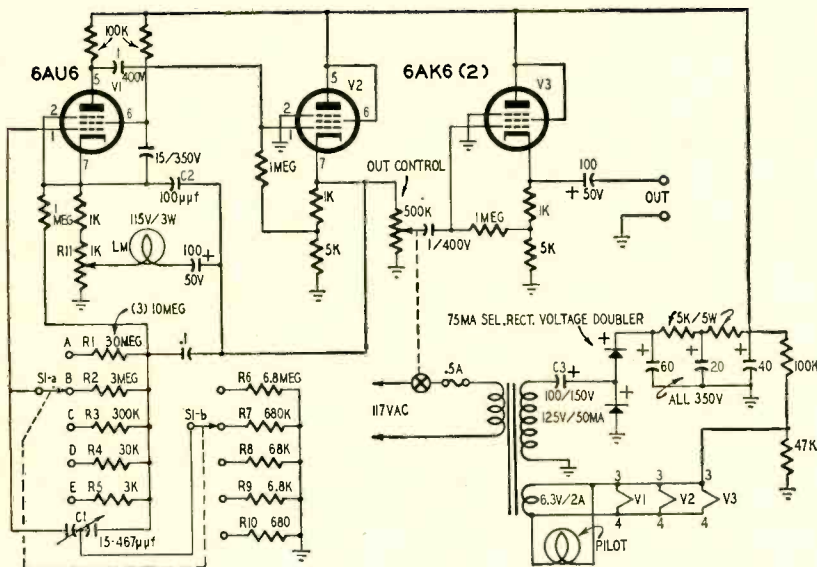

Fig. 1—Schematic of wide-range oscillator. Bridged-T circuit is used.

already on hand, keep the following in mind. The main difficulty will be capacitance coupling between a.c.-carrying components and the grid circuit components of V1. A shield fencing off the power transformer from the variable capacitor C1 is necessary. It need not be steel. Aluminum will do, since the coupling is electrostatic rather than electromagnetic. Other components such as C3 and the selenium rectifier should be mounted below the chassis

course, a cabinet or enclosure of some sort is absolutely essential for hum-free operation.

C1 has a 3/8-inch shaft diameter which must be insulated and reduced to 1/4-inch diameter to fit the dial mechanism. These two functions can be combined by modifying a National TX9 flexible coupling. This coupling has enough stock to drill the 1/4-inch hole to 3/8-inch. First disassemble the coupling, then drill out one collar to 3/8 inch. Solder the collar and flat flexible spring back together. A small piece of 1/4-inch shafting (the excess cut from the shaft of the output control) is used to couple the dial to the flexible coupling. C1 is insulated from the chassis by mounting it with three 3/4-inch ceramic standoffs.

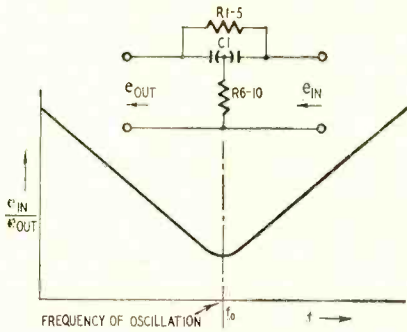

Fig. 2—Bridged-T characteristics.

and as far away from V1 as is practicable. R-C filtering in the power supply is preferable to using a choke, since the smaller area of the resistors reduces undesirable capacitance coupling. Shielding the heater wiring, particularly that of V1 is also helpful in reducing capacitive effects. Pacing the filaments at a positive voltage above ground also reduces hum due to heated cathode emission. Of

Adjustment and calibration

After the unit is completed, let it warm up, and observe the waveform on an oscilloscope. Adjust R11 until there is no noticeable distortion. Give R11 another slight twist to reduce distortion to an even lower amount. Actually, an oscilloscope can give only a rough indication. Distortion of 10% or less is not even observable on a scope. However, don't go overboard on this adjustment with the thought in mind of reducing the distortion to zero, because moving the arm of R11 down also reduces the available output voltage.

Loosen the trimmer capacitors on C1 to almost minimum capacitance. Leave

Parts for wide-range oscillator.

Resistors: 1—680, 3—1,000, 1—3,000, 2—5,000, 1—6,800, 1—30,000, 1—47,000, 1—68,000, 3—100,000, 1—300,000, 1—680,000 ohms, 3—1 megohm, 1—3 megohms, 1—6.8 megohms, 3—10 megohms, 1/2 watt, 2—5,000 ohms, 5 watts, 1—1,000, potentiometer; 1—500,000 ohms, potentiometer (Centralab type B with C2 taper, with switch).

Capacitors: 1—100 μf, ceramic; 1—0.1 μf, 200 volts, paper; 2—1.0 μf, 400 volts, paper; 1—15 μf, 1—60-20-40 μf, 350 volts, electrolytic; 2—100 μf, 50 volts, electrolytic; 1—100 μf, 150 volts, electrolytic; 1—2-gang, 15-467 μf, variable (Allied Radio Co. No. 61-059).

Miscellaneous: 2—6AK6, 1—6AU6, tubes; 1—selenium rectifier, 75 ma, voltage doubler (Sarkes-Tarzian 78D); 1—3-watt lamp, 117 volts; 1—transformer, 125 volts at 50 ma, 6.3 volts at 2 amps (Stancor PA8421); 1—2-pole, 6-position switch (Mallory 3126J); 1—fuse with holder, 1/2 amp; 3—ceramic standoffs; 3—tube sockets; 1 set—output terminals; 1—pilot light and assembly; 1—cabinet, 6 x 6 x 6 inches; 1—insulated coupling shaft; 1—dial face.

some adjustment to realign the instrument if the calibration should ever go off. The instrument is now ready for calibration.

The lower frequencies can be calibrated with Lissajous figures using the 60-cycle power line as a standard. The higher frequencies can be calibrated with a broadcast receiver. For example, 100-ke output from the oscillator when fed into the antenna of a calibrated broadcast receiver will produce harmonics every 100 kc. Thus, by subtracting two harmonic frequency readings on the receiver, the oscillator output frequency can be determined and a calibration point marked on the dial. The higher frequencies can be identified in the receiver directly. END

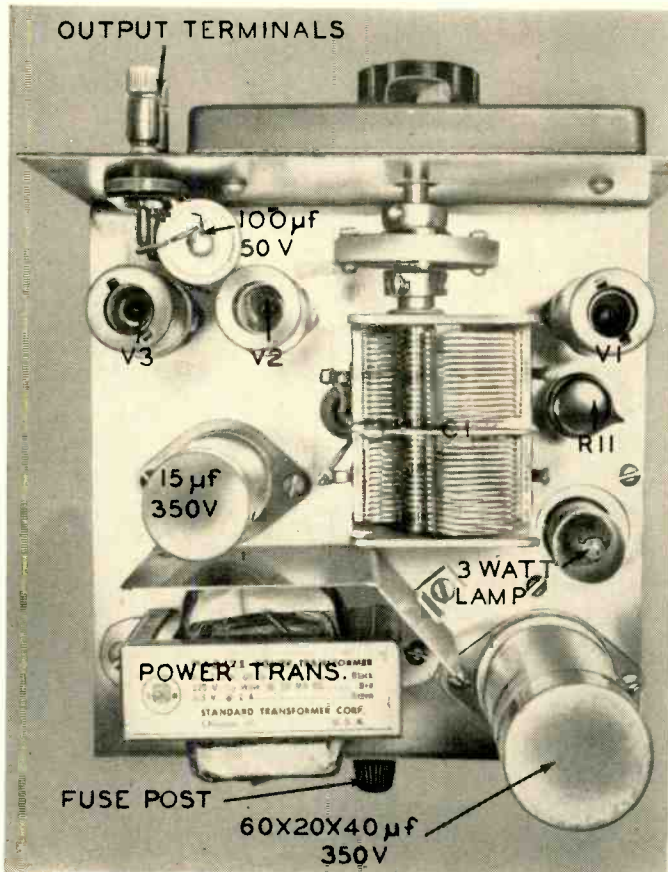

Fig. 3—Top view of the oscillator.

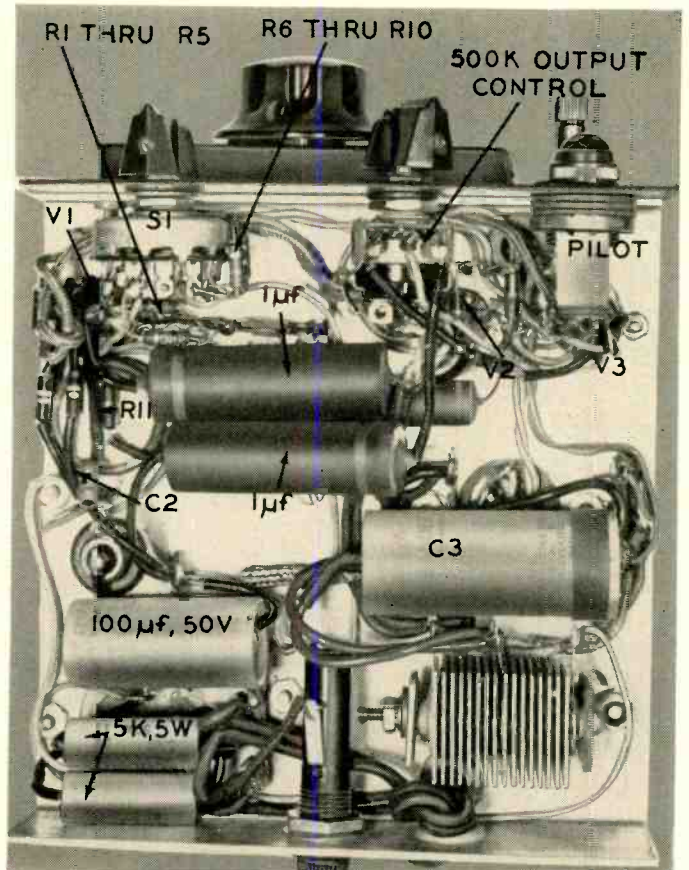

Fig. 4—The oscillator underchassis.

Obtain wide range
and good quality with

A VERSATILE TAPE RECORDING AMPLIFIER

By GEORGE L. AUGSPURGER

USING tape for dubbing and playing back musical recordings has become so popular that today most custom audio systems contain a tape recorder of some sort. Unless an experimenter has the money to buy a professional machine the alternative is usually to build-in a standard \$200 home tape recorder and put up with second-best quality. The ridiculous performance claims of some of these low-cost machines, based usually on some small portion of the complete recording chain such as the input preamplifier, has trapped a great many unwitting audiophiles into this compromise. One of the few tape transport mechanisms

available to the home constructor which bridges the gap between the "Little Gem Pushbutton Wonder" and high-quality broadcast recorders is the Amplifier Corporation of America "Twin-Trax" mechanism. Because of its moderate price, sturdy construction, and numerous quality design features, this unit has become popular with moderate-income experimenters.

My tape recording and playback amplifier can be used with the Twin-Trax or any other high-impedance head transport chassis. When used with the Twin-Trax, the amplifier will record and play back music with a frequency range of 50 to 9,000 cycles within 3 db at a tape speed of 7½ inches per second. The harmonic distortion at full recording modulation does not exceed 5% at any frequency within this range and the 5% figure is reached only at the lowest frequencies recorded. These figures include the entire chain from the input to the recording amplifier, through the recording medium, and out the final stage of the playback amplifier.

An examination of the response curves (Fig. 1) will show that gain at 12,000 or 14,000 cycles is definitely

within the range of a little more equalization and there is a strong temptation to attempt it. In practice there is a very good reason why this is not a good idea. The plotted response of the recorder above 5,000 cycles is misleading because in the upper high-frequency range, beat frequencies between the audio signal and the supersonic erase voltage are pronounced. This is a phenomenon which is strictly hush-hush among recorder manufacturers. While most literature on the art of tape recording states that a bias frequency of at least five times the highest audio frequency to be recorded must be used to avoid beat interference, the interference in practice becomes noticeable at about one-tenth the bias frequency.

Therefore, the response curve above 6,000 cycles progressively indicates a much higher level than would be present if the beat interference didn't exist. Consequently a curve which begins to droop at about this frequency and has a gentle roll off to about 12 kc was aurally determined as the best compromise between flat high-frequency response and excessive beat-note distortion. This beat-note difficulty is not a

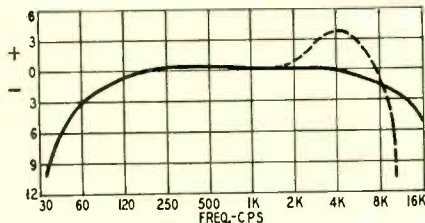

Fig. 1—Responsive curves. Solid line—authors circuit; dotted line—A.C.A.

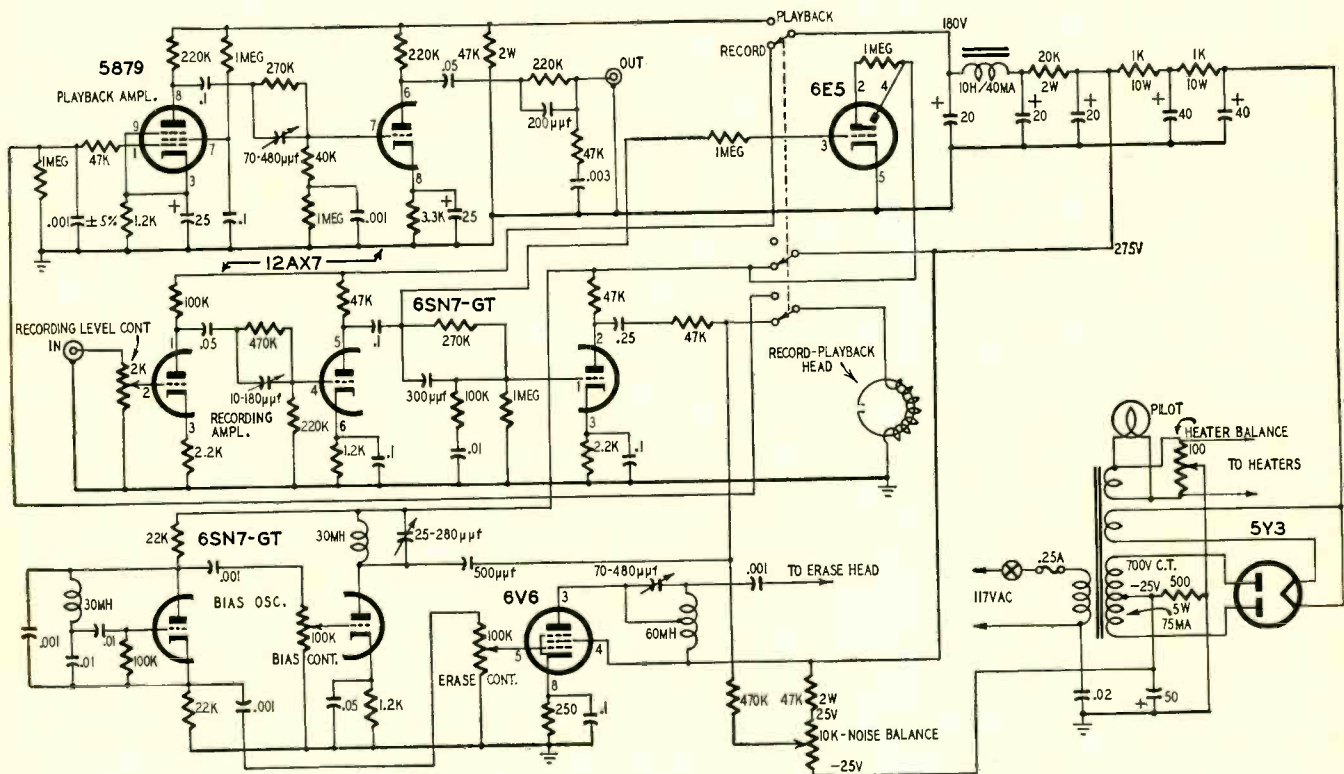

Fig. 2—Schematic of the versatile tape recording and playback amplifier. Unit contains bias and erase controls.

peculiarity of our circuit or the Twin-Trax mechanism since tests made on three of the lower-priced professional machines showed these same beat frequencies being introduced into the recording above 5,000 cycles. This is undoubtedly the reason why the newer professional machines use a bias source of about 100 kc instead of the 50 to 60 kc normally used. Unfortunately, we cannot use the same trick since capacitive losses at such high frequencies would make tape erasure practically impossible unless a separate oscillator were used for biasing and erasing.

The circuit

The schematic (Fig. 2) is a refinement of the A. C. Shaney circuit recommended by A.C.A. for use with the Twin-Trax chassis. The beauty of this design is that all circuitry is straightforward and simple. Any modifications can be made easily with predictable results.

Fig. 2 shows the record-playback head feeding the grid of a 5879 tube in parallel with a .001-uf capacitor which resonates with the head inductance to give considerable high-frequency boost. The 5879 is used because it permits a.c. filament operation without introducing audible hum, and also it is a low-microphonic tube that requires no special mounting. To keep tube hiss inaudible it is necessary that the plate and screen resistors of this stage be of low-noise deposited carbon or wire-wound construction.

The 5879 feeds into an interstage equalizer which boosts both highs and lows. A trimmer capacitor is used to adjust the high-frequency turnover for the flattest possible response curve. The next stage also feeds an interstage equalizer. I discovered that a more satisfactory response could be obtained by using two equalizers adjusted to different turnover frequencies. The proof of this can be seen by comparing the curve in Fig. 1 with that of the commercial Twin-Trax recorder. In view of what I mentioned about beat-note distortion it can be seen that this slight change results in a far more satisfactory high-frequency curve.

The output of this second equalizer is about 0.25 volt and must be fed into a grid resistor of at least 1 megohm. It so happens that the tape recorder in my system is located adjacent to a mixer-preamplifier unit which provides the necessary gain and high impedance. But for normal use, it would be better to include another stage of amplification in the recorder chassis itself as is shown in the improved circuit in Fig. 3.

The first stage of amplification in the recording amplifier is half of the same tube which acts as the second stage in the playback amplifier. The plate voltage of one section is removed when the other is in operation, and the impedance of the first recorder amplifier grid is kept low; this results in no ill effects. However, for maximum stabil-

ity and to permit separate record and playback heads to be used for continuous monitoring while recording or dubbing from one machine to another, the complete separation of the two functions as shown in Fig. 3 is recommended.

Following the initial stage of voltage amplification, a section of high-frequency boost is introduced before the next stage, which further improves the high-frequency end of the recording spectrum. This small amount of boost

can be safely inserted *before* the recording level indicator, since in musical passages the extremely high frequencies (overtones) will be at least 8 db below the remainder of the frequency range. Consequently the insertion of a small amount of preemphasis will not cause the eye tube to give a false indication.

The interstage equalizer between the halves of the 6SN7-GT provides a recording curve that has nearly constant overload characteristics throughout the musical range. Until a standard equal-

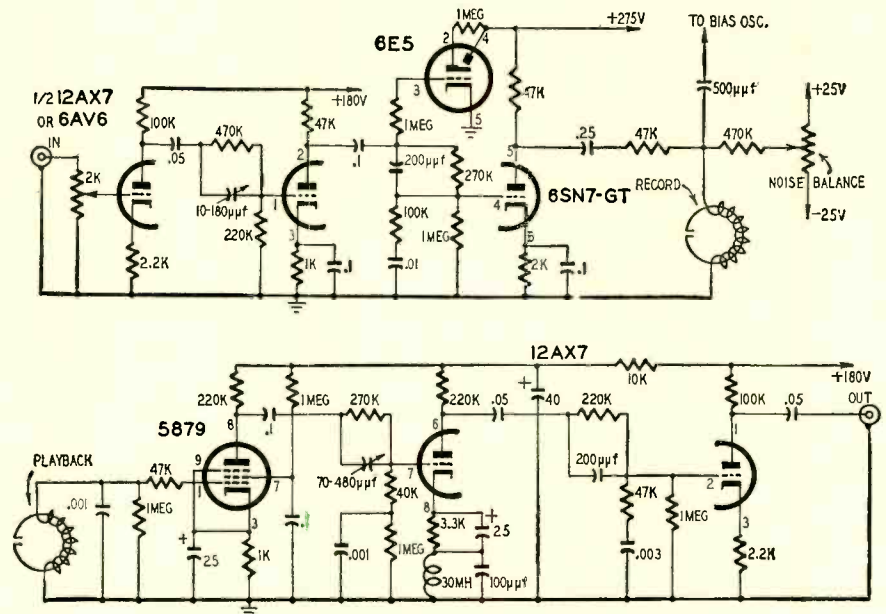
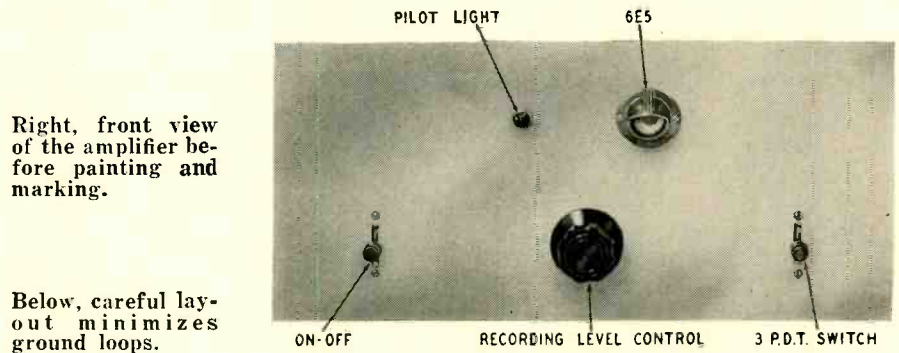
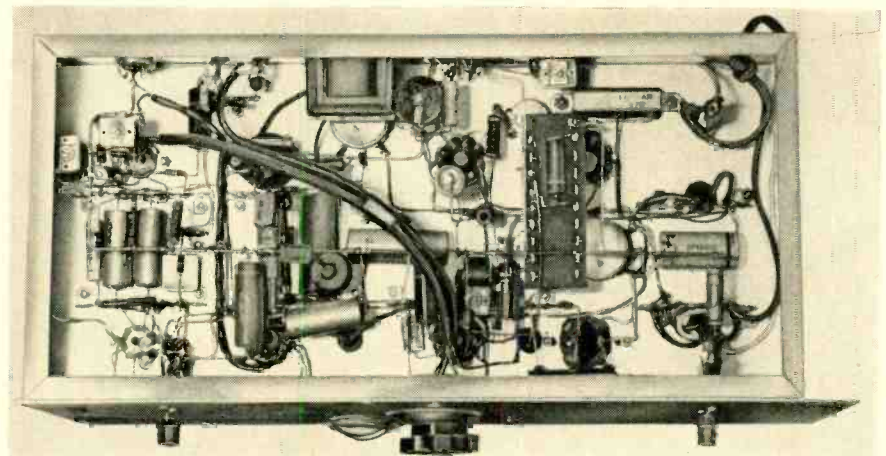

Fig. 3—Improved circuitry for the recording and playback circuits.



Right, front view of the amplifier before painting and marking.

Below, careful layout minimizes ground loops.



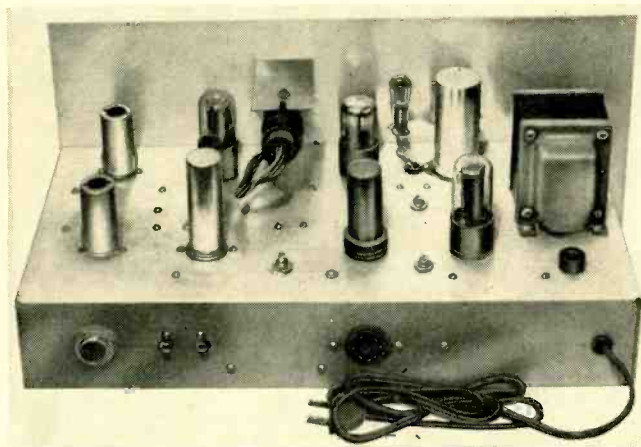

Rear view of the tape recorder amplifier.

ization is adopted for tape recorders this seems the most sensible approach since the recording-level indicator will give an accurate indication of proper modulation regardless of the frequency spectrum of the incoming signal. The cathode capacitors of both halves of the 6SN7 enter into the recording equalization as well as the interstage circuits.

The record-playback head is series fed from the second plate of the 6SN7, allowing a tiny amount of direct current to flow through the head, in the record position. This can be varied both as to potential and polarity so that by proper adjustment of the noise control the background noise of plastic-base tape can be made inaudible even at high listening levels.

The bias and erase oscillator circuit is more elaborate than that normally found outside professional-quality recorders. However, the design is definitely worth while in providing optimum adjustment of both erase and bias voltages and in providing a pure sine-wave source for lowest possible distortion and tape noise. Except for the trimmers to peak the tuned circuits, the circuit is identical to that used in commercial A.C.A. machines. It is also the same circuit used in the original Brush BK-400 series of tape recorders.

Construction

Wiring the unit is not difficult, especially if a large chassis such as that shown in the photo is used. By allowing plenty of space, the three sections of the unit can be separated physically to avoid interaction. Ground loops in the playback amplifier must be avoided. The chassis has a separate ground bus with the chassis and playback amplifier grounded at one end and the power supply at the other. All other stages are grounded along the bus in the order of their signal level. If good grounding practice is followed and the filament balancing pot is properly adjusted, the hum level should be inaudible unless the playback head is located in the magnetic field of the power transformer. As a matter of fact, the only hum that

can be heard in the unit is that picked up by the playback head from the motor of the transport mechanism.

Adjustment

Set the bias and erase voltage potentiometers about one-quarter of full rotation. With an a.c. voltmeter or scope, adjust the peaking capacitors to give maximum output. The oscillator waveform may be checked with a scope to make sure the signal is clean and the frequency is approximately 60 kc.

Now set both bias and erase voltages to zero and on a clean tape record a 1,000-cycle tone at a level slightly more than that required to close the eye tube. With a scope or vacuum-tube voltmeter connected across the recording head, vary the bias voltage in definite steps so that when the tape is played back you can keep track of the bias voltage that was used. When the tape is played back and the output is monitored on the scope it will be found that as the bias voltage is increased the distortion of the sine wave will decrease and the signal level will rise. Eventually a point will be reached where the level remains constant and distortion is not detectable. The proper adjustment of the bias voltage is just a little past this point where distortion disappears. The voltage will probably be about 150.

With the bias voltage properly set, again record an overmodulated tone on the tape. Rewind the tape and with no modulating voltage present adjust the erase voltage in definite steps just as the bias voltage was adjusted previously. Now play the tape and monitor the output. A point will be found where the signal is completely erased and then another point where the tape noise level reaches a minimum. The proper adjustment is that point beyond complete tape erasure at which the background noise is the lowest. The noise-adjusting potentiometer can now be set to bring the noise level down to an absolute minimum which should be audible only at extremely high gain settings. The heater balancing potentiometer is likewise adjusted.

By sweeping the audio spectrum with an audio generator and recording this signal, then playing back the tape and monitoring the output, the various equalization controls can be adjusted by trial and error until an over-all response curve such as the one shown is achieved. With these adjustments completed, the recorder can be connected into your audio system and an aural check can be made.

In both circuits a low value is shown for the recording level control. The recorder should be driven from a fairly low-impedance source such as the cathode follower found on many pre-amplifiers. If a 500,000-ohm or 1-megohm potentiometer is used to control the recording level, the input capacitance of the first stage will seriously attenuate the upper audio frequencies at mid-range settings. If an exceptionally low-noise power amplifier such as the Williamson or Ultra-Linear is used in your audio system, the recorder may be simply bridged across the voice coil output. Even with the varying impedance of a speaker load, the Ultra-Linear is so well regulated that no adverse effects are noted from the bridging connection.

If the unit is to be bridged across a speaker, a wire-wound potentiometer of 10,000 to 20,000 ohms may be used for the recording volume control. Since such a potentiometer has a linear rather than a logarithmic taper, it tends to expand the range as the setting is advanced. This is ideal if the signal source is not much greater than the voltage required to fully modulate the recorder; such a condition exists when the voice-coil connection is used.

Parts for recorder amplifier

Resistors: 1—250, 3—1,200, 2—2,200, 1—3,300, 2—22,000, 1—40,000, 5—47,000, 3—100,000, 4—220,000, 2—270,000, 2—470,000 ohms, 6—1 megohm, 1/2 watt; 1—20,000, 2—47,000, 2 watt; 1—500, 5 watt, 2—1,000, 10 watt; 1—100, 1—2,000, 1—10,000, 2—100,000 ohms, potentiometers.

Capacitors: 1—200 µf, 1—300 µf, 1—500 µf, mica, 400 volts; 5—0.01 µf, paper, 400 volts; 1—0.01 µf, mica 5%, 400 volts; 1—0.03 µf, 3—0.1 µf, 1—0.2 µf, 2—0.5 µf, 6—0.1 µf, 1—0.25 µf, paper, 400 volts; 2—25 µf, 25 volts, 1—50 µf, 50 volts, 1—20-20-20 µf, 1—40-40 µf, 450 volts, electrolytic; 1—10-180 µf, 2—70-480 µf, 1—25-280 µf variable.

Miscellaneous: 1—5Y3-GT, 1—6E5, 1—6V6-GT, 1—12AX7, 1—5879, 2—6SN7-GT, tubes; 6—tube sockets; 1—6E5 assembly; 1—power transformer, 700 volts c.t. @ 75 ma, 5 volts @ 2 amps, 6.3 volts @ 3 amps; 1—filter choke, 10 h, 40 ma; 1—1/4-amp fuse and assembly; 1—pilot lamp and assembly; 2—30-mh coils; 1—60-mh coil, c.t. (J. W. Miller 693-T); 1—s.p.s.t. switch; 1—3-p.d.t. switch; 1—chassis; 1—line cord; terminal strips.

For the audio enthusiast and experimenter the design shown is a good one since it is not tricky, not difficult to build, and can be easily altered to fit individual circumstances. The amplifier may be used with any transport mechanism which uses high-impedance recording and playback heads. If a unit other than the Twin-Trax is used, it may be necessary to alter the values of one or two of the equalizer components to obtain best results. Since the bias and erase voltages are completely adjustable, this section of the design can be used with any high-impedance erase and recording heads. END

FOR GOLDEN EARS ONLY

A review of the latest in audio components and recordings of interest to the hi-fi enthusiast

By MONITOR

AN unprecedented thing happened at our house a few days ago. We have often forgotten at night to shut off the sound system from a radio program source after the station signed off, since the over-all hum level is inaudible as near as one foot to the speakers. It never happened with a record because the hum and rumble picked up by a magnetic pickup, on our best turntable, let alone the changer, was always plainly audible. But this time it not only happened with a record, but with a microgroove record, and moreover with the pickup in the final, run-out grooves. Our speakers are mounted in a wall which divides the house in two and distributes the sound all over it. Ordinarily the hum and rumble would be plainly audible even in our bedroom. But this time we went off to bed, completely unaware of the revolving record.

The D & R turntable

I can think of no more severe test of a turntable, nor of a higher tribute to the D & R turntable which produced this incident. At a net price of just under \$80 the D & R is not inexpensive; but that and the slight inconvenience of changing speeds are the only drawbacks.

It is extremely difficult to measure the performance of a turntable with normal audio test equipment and thus obtain quantitative data on hum, rumble, flutter, and wow. D & R claims a total noise level of -60 db, unmeasurable hum, negligible wow, and -60 db flutter. No matter how I measure it, I find no reason whatever to quarrel with these claims; they are certainly not exaggerated.

By listening tests, the hum is inaudible even at "concert hall volume" with a G-E cartridge fully equalized for the NAB bass slope on the innermost grooves of a classical microgroove record. Magnetics with higher output, normally less susceptible to hum, make no noticeable difference. The rumble and flutter are scarcely audible with speakers of very superior response below 40

cycles, such as corner horns, bass couplers and extremely large reflex enclosures. You can easily discern variations in the relative hum and rumble recorded on records. I have no means of measuring wow, but I do have records which are very sensitive to it, and I could not distinguish any, though I presume there must be a little.

I do not own one of those de luxe broadcast tables with remote drive, hysteresis motors, etc; but my FM receiver, which uses a frequency-counting detector is flat to far below 20 cycles, and I hear considerably more hum and rumble on the recorded output of all but one of the dozen FM stations we receive, and these include some of very high standards. It is not fair, of course, to compare a turntable with a changer, even the best changer. The additional complication of changing makes the noise problem infinitely more difficult to solve. With both the Cook and Clarkstan IM records I recorded the lowest IM figures I have ever achieved, and the IM with the D & R is greatly superior to that of a moderately good single-speed player, and that of an excellent though not the very latest changer. As

near as I can determine, the IM contributed by the turntable itself is completely negligible. In short, here is a turntable which does its job of revolving the records without contributing any significant modification of the music on the record—and that is just about as high fidelity as you can expect from a turntable.

Rumble and flutter are produced by transmitting the vibrations, inescapable with any motor, to the turntable and thereby to the pickup. The isolation in this turntable is extremely admirable. The motor is mounted on airplane type vibration dampers, and the whole turntable is mounted on a 3/4-inch wood base, poorer in communicating vibration than a metal base. But these are elementary measures. The table is driven by an idler which contacts the *outside* rim of the table. The table, including the rim, is made of nonmagnetic nonmetallic material—masonite I would guess—which also reduces the passage of vibrations. The neoprene idler itself is 3 inches in diameter. The size and material both contribute to the dampening. Furthermore, the idler floats completely on feet made of damping felt; no portion of the

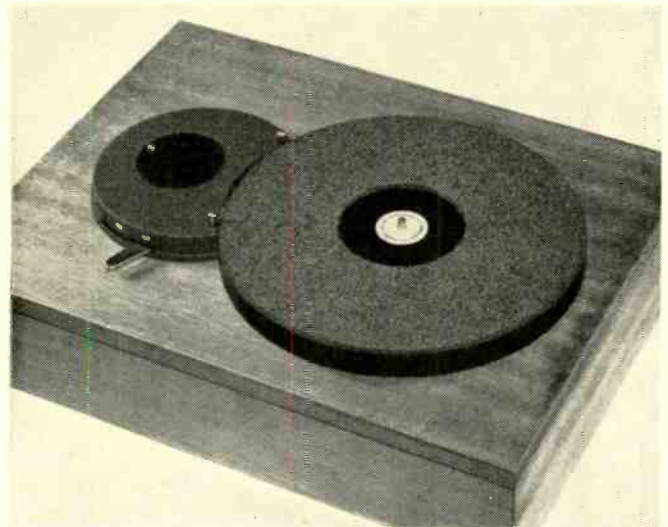

Precision D & R turntable. Runout tolerance on table periphery is .001 inch.

AUDIO—HIGH FIDELITY

mount, except the spring, has a metal-to-metal contact with any portion of the motor mount. The spring is very light and probably supplies considerable damping at the rumble frequencies. The record itself rests on a 1/8-inch thick pad of cork and latex composition. There are very few more nonresonant materials. Finally, the spindle of the table rides in several ounces of viscous oil, which also contributes very considerable damping.

The cork-latex table top is far superior to felt or flocking, and even to rubber, in my estimation. It does not accumulate lint and, judging by its appearance, could be washed periodically with brush and detergent water to remove accumulated dust and grit. It really grips the record without slippage—even those small 45's which have such an annoying tendency to slip. Because a small mercury switch is used, there are no switching clicks or thumps.

I have only one small gripe. Change of speed requires changing pulleys by hand. The manual change does complicate matters just a little for non-technical members of the family, but the average audiophile who plays mostly 33-r.p.m. records will not be bothered by this; and those who must play 33's and 78's interchangeably will be only slightly inconvenienced. Still this is a small price to pay for the turntable's behavior in reproducing records.

Kingdom-Lorenz speakers

One of the big problems the present boom in high fidelity presents to the high-fidelity dealer and installer is that of providing adequate but compact speaker systems for apartment and small-home use. There are any number of excellent large enclosures; but there is a relative scarcity of small ones which will deliver real high fidelity. In the May issue I reviewed the Baruch-Lang speaker; this month I had the opportunity to use a somewhat more costly outfit distributed by Kingdom Products, using speakers made by the German firm, Lorenz, in a very small enclosure supplied by Kingdom.

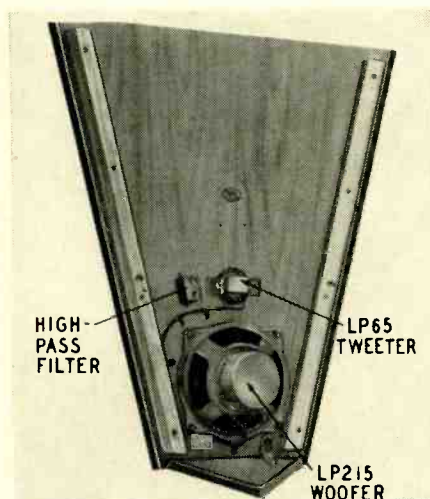

The Lorenz sound corner. Unit provides a range of 31 to 16,000 cycles.

These speakers were designed primarily for use in multiples of four in movie theaters; but their performance in the home is outstandingly ear-catching. The woofer is an 8-inch job with a resonance in free space of about 80 cycles. It has a remarkable transient response. This is partly the result of the highly efficient permanent magnet (Alnico 400) and the cone suspension; but it is also partly due to the method of mounting the speaker and to the insulation, provided by a heavy felt gasket, from the resonant wood of the enclosure. (To experimenters, I commend the idea of replacing cardboard gaskets with felt ones.) In a Rebel type Klipsch corner horn, this little woofer astounded me by reaching down into the lowest octave and reproducing 30-cycle tones with good form. The response was, to my ears, about as flat as that of a very costly 15-inch speaker.

The tweeter, a tiny affair little larger than a railroad watch, with a transparent plastic cone, is equally impressive. Not having a sound-level meter, I could not make exact acoustic measurements of its output; and unfortunately my ears are beginning to confess their age. Substituting my daughter's ears which are good to beyond 20,000 cycles, I verified the claimed range of 16,000 cycles. The tweeter is, if anything, a little too efficient for today's flat high-fidelity systems and could use a level control to reduce the output a little; but many high-fidelity addicts who glory in highs will like it just as it is. The response is very clean and smooth. The tweeter has a totally enclosed back and can be used in labyrinths, folded horns, etc., without fear of setting up interference patterns or standing waves. Kingdom offers a cased high-pass filter for coupling the two speakers together. As interesting as the performance are the prices: \$22.50 for the woofer, \$8.50 for the tweeter, and \$4.50 for the filter.

For these speakers Kingdom is producing a very small enclosure, only 13 inches deep, 16 inches wide and 19 inches high, which totals a mere 2 1/4 cubic feet of enclosure. The enclosure is a folded-reflex design, a partition being used to approximately double the length of the air column back of the speaker. The performance of the outfit in this enclosure is excellent. There is a trace of cavity resonance or boom, typical of reflex enclosures, but it is not annoying.

One caution: these speakers are not meant to take more than about 6 watts of electrical input; don't be tempted—when showing them off—to overdrive them.

The Titone ceramic cartridge

As far as most Golden Ears are concerned, the piezoelectric cartridge has been as obsolete as the 50-cent plate lunch. They might be good enough for the great indiscriminating masses, but no real high-fidelity crank would think for a moment of using anything but a magnetic, velocity, or modulation cartridge. Sharing this point of view, I was

in for a shock when I gave the Sonotone Titone turnover cartridge a fair trial.

I tested it on a new pickup arm I was constructing. Aside from the use of fine bearings to provide low friction in both planes, this pickup was distinguished by providing adjustments for tracking angle, needle angle, and needle pressure, and by having cartridge mounts made of buckeye wood, a close-grained but soft wood of very low resonance. The theory was that the wood mount would isolate the cartridge from any resonance in the cast-aluminum arm.

In this arm, the Titone began to deliver reproduction which was definitely worth listening to. After finding the optimum adjustments the cartridge tracked perfectly and with no instance of skip, sliding, or jumping, with a pressure of only 4 grams. The high-frequency response was now clean and smooth; the cartridge delivered, so far as my ear could discern, all the high frequencies on my favorite wide-range recordings. Measurement showed that the high-frequency response easily reached 15 kc. The bass was somewhat deficient, as compared with a properly equalized magnetic, but a little judicious boosting fixed that.

Very critical listening (as well as measurement) revealed somewhat more distortion than a good magnetic produces; but this was largely an academic matter because the distortion was not high enough to mask the subtler components of the music, and it is doubtful that even all golden ears would notice it as long as the needle remained in good shape. The only marring note was the slight resonant peak at 5,000 cycles, which increased the record noise somewhat and accentuated the harmonics in that region, producing a somewhat sharper brassiness than most magnetics.

The curve of the Titone most completely complements the new RIAA-ORTHO but works all right with both the LP and NARTB curves also. Fed into the 500,000-ohm input of most crystal channels of amplifiers, it could use an additional 3 db per octave of bass boost. This could be provided by increasing the load resistance as per Fig. 1.

However, load resistances higher than 1 megohm may produce contact potential bias and this may shift the operating conditions of the tube downward, too close to the cutoff bend. A simpler method would be to shunt the 500,000-ohm input resistance with a capacitor of about .004 μ f which, with the approximately 100 μ mf of cable and stray capacitance, would produce just about flat equalization of the RIAA curve, and would be very close for both the LP and NARTB curves. This, however, will reduce gain by about 20 db, which may or may not require more amplifier gain.

(Experimenters might like to try the feedback circuit of Fig. 2 which would provide the bass boost and also probably flatten the resonant peak. In this circuit the capacitor determines the crossover for bass boost, and the resistor parallel to it limits the boost; the resistor in

series determines the amount of feedback which should be adjusted to produce the best leveling of the resonant peak. I used this circuit some years back with excellent results and though I haven't tried it with the Titone I believe it would work all right. Those interested may like to look up the original paper of E. J. O'Brien in *Electronics* for March, 1949: "High Fidelity Response From Phonograph Pickups.")

New records

**A Study in High Fidelity—
Capitol SAL 9020**

This recording was edited by Charles Fowler, editor of *High Fidelity*, and is accompanied by a printed commentary. I commend the lack of commentary on the record. Music can be tolerated after scores of repetitions, but a voice repeating the same old song and dance in commentary, can become very irritating.

The most valuable sections of this record are the two bands of percussion instruments played by Hal Rees, chief percussionist for Twentieth Century-Fox. These two hands alone test almost any audio quality. They are especially valuable for simple tests of definition and naturalness, which is principally a function of very flat and distortion-free response. Comparisons of the very slight differences between some of the instruments yield an excellent measure of definition and naturalness.

Though I ordinarily lean to classical music, I found the popular side of this recording more interesting and rewarding. This is partly because the music is less complex and more easy to apply to testing, but also because the classic side is not as well balanced—it has too many high and lows for my taste. However, the classical side does offer some interesting test material, particularly the very odd tone of the piano in the Shostakovich concerto. I commend also the final band on the popular side, by Stan Kenton's orchestra, for distortion testing. Kenton—like Pearl White in early

movie days—has a cliff-hanging style in which the music is always teetering on the very edge of outrageously unpleasant dissonance. As recorded, this band of the record is very free of distortion and Kenton sounds good. Any system distortion will throw this section over the cliff into unpleasantness. Since this is the innermost band, it will produce large amounts of IM distortion with worn needles, improper needle alignment or tracking, etc; hence it should prove very useful for testing all these possibilities.

Pietra and Percussion Dances, by Harry Partch. Played by Gate 5 Ensemble. Available by mail for \$8.00 (incl. postage) from: The Gate 5 Ensemble, 3030 Bridgeway, RFD 67, Sausalito, Calif.

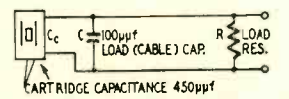
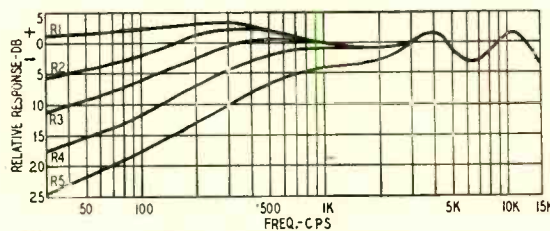

R1-5MEG; R2-2MEG; R3-1MEG; R4-500KΩ; R5-250KΩ
ZERO DB = .85V AT NORMAL LP RECORDING LEVEL

Fig. 1—Loading effects on cartridge response for Titone turnover 9980-S.

This is likely to make an impression of wondrous bewilderment when heard for the first time. It is written in a 43-tone-to-the-octave scale and is played on a set of absolutely unique instruments called, kitharas, harmonic canons, diamond and bass marimbas, cloud chamber bowls, eroica, adapted strings, etc. The result is entirely individual and, after the first bewilderment, most interesting. I'm not sure how seriously it is meant to be taken. But regardless of that, the high-fidelity brotherhood will find a collection of sounds they have probably never heard before and are likely never to hear again. The recording is not particularly outstanding

**Trio-Phonic Demonstration—
Tempo DM-38**

This is a special job produced by Tempo for Hoffman to promote the sale of Hoffman's Trio-Phonic TV receivers and distributed to its own dealers by Hoffman. It was carefully tailored for that job; and to satisfy the curiosity of those readers who may have heard of it and wondered about finagling one for high-fidelity testing or

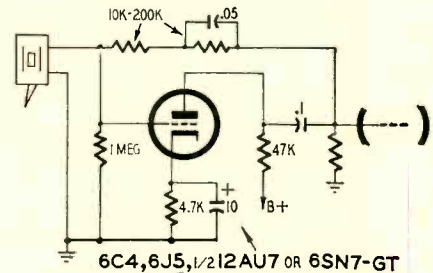
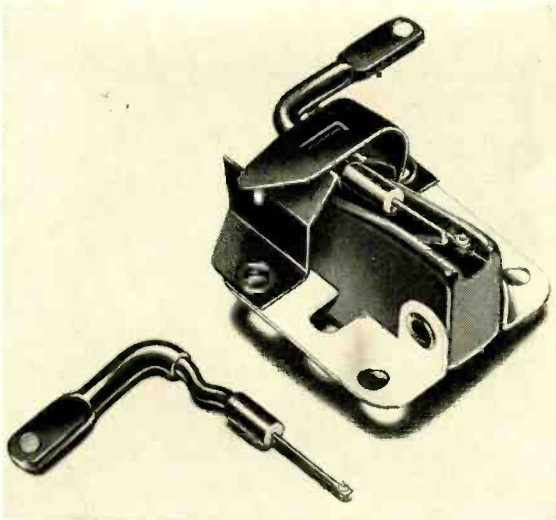

Fig. 2—A Titone feedback circuit.

demonstration, I report that it is not one whit better for this purpose than any half-dozen popular records, of any speed and almost any age, you may pick up at random. The commentary verges on the ridiculous (sample: "reproduces down to 50 cycles—as low as the ear can hear"). Some of the selections have no top nor bottom worth mentioning, and only "Sweet Georgia Brown" by Brother Bones and "Ju-Ju" by Thurston Knudson offer any material which would tax the capabilities of a moderately good table-model radio. Its function is to make the Hoffman sets sound good, and it will probably do a moderately good job of this with a good pickup.



Titone turnover cartridge. At lower left is the replaceable arm and needle assembly.

HIGH-QUALITY AUDIO

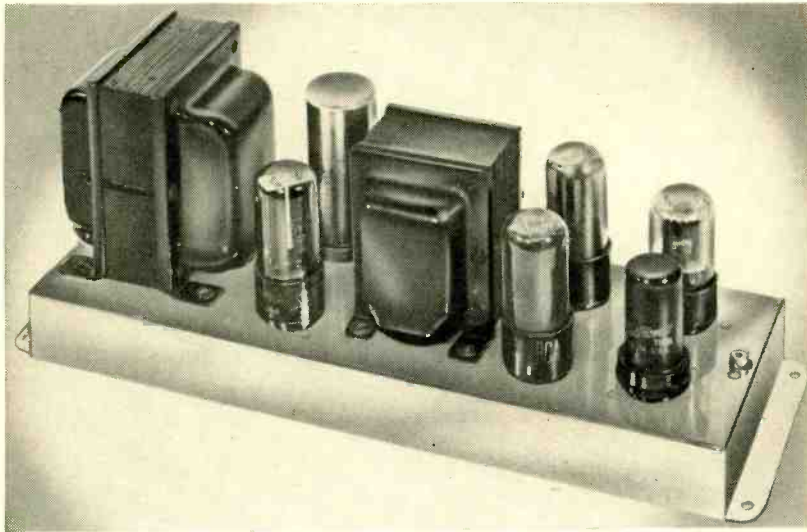

The Radio Craftsmen 400 amplifier—contains a split-load phase inverter.

Part XI—Phase splitters; the center-tapped transformer; the self-balancing circuit; and the cathodyne (split-load) circuit

By RICHARD H. DORF*

THE push-pull action of the output stage of an amplifier depends largely for its quality on the balance of the signals applied to its grids. If the two signals are not exactly 180° out of phase, or if they are not of the same amplitude, at all frequencies within the band to be passed, the output stage will not cancel even-harmonic distortion. Unbalance in a phase splitter is a source of nonlinearity in an amplifier; and nonlinearities generate harmonic and, more serious, intermodulation distortion.

Center-tapped transformers

The simplest type of phase splitter is a transformer with a center-tapped secondary, in a circuit like that of Fig. 1. The stage (V1) preceding the output stage V2-V3 is plate-loaded by a transformer primary. When the center-tap of the secondary is grounded, the voltages appearing at the ends of the secondary are opposite in phase with respect to the grounded center-tap, and, provided the tap is exactly centered, are equal in amplitude.

The transformer phase splitter is very stable (it cannot be adjusted or altered). It is practically a necessity when the output tubes draw grid current, at which time the signal source must have a very low impedance so that the terminal voltage will not vary with the current. While tube phase splitters can be used, transformers are usually preferable; the secondary impedance can be made very low, and the power transferred from the driver stage is limited only by the power the driver

can furnish. This is not true of resistance coupling, where regulation is inherently poor. Transformers are often used in equipment where the prime requisite is long-time stability.

For high-quality work, however, the transformer phase splitter is both expensive and bulky. A first-class home-music-system amplifier today has a bandwidth extending to 50 or 100 kc or more (to allow for plenty of feedback). Some transformers are made to pass this wide band but they are very expensive.

Low-frequency response is also a problem. The primary inductance must be high to present sufficient load impedance at bass frequencies. In any reasonably sized transformer there cannot be enough iron to permit this unless the primary is operated without d.c. passing through it. Therefore the cir-

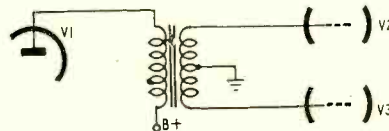

Fig. 1—Simple type of phase splitter—the center-tapped transformer.

cuit of Fig. 1 must be changed to that of Fig. 2 where the plate of V1 is shunted through R1 and the transformer primary isolated from d.c. by C1. But now C1 and the transformer primary may form an L-C circuit resonant at some frequency in the band; so C1 must be chosen with care. For amplifiers which require any sizable driving voltage for the final stage, the existence of R1 limits the B voltage applied to the tube plate and offers an additional handicap. A choke of course can be

used in place of R1, but this adds more complication.

Self-balancing circuit

The logical and practically universal choice for phase splitting in "high-fidelity" amplifiers has been vacuum-tube circuits. Fig. 3 shows a self-balancing circuit which is perhaps one step advanced from the one shown last month. Actually, it is never completely in balance, but if the gain of V2 is high enough, it can be considered balanced for all practical purposes.

Let us assume for a moment that the input signal fed to the grid of V1 goes negative. At that instant the plate of V1 goes positive, with a positive voltage appearing across the series combination of R1 and R3. The portion of that voltage appearing across R3 is applied to the grid of V2. The result is a negative voltage at the plate of V2. This negative voltage appears across the series combination of R2 and R3. That portion of it which appears across R3, being negative with respect to ground, tends to cancel the R3 voltage which is positive due to the output of V1. If it were as large, it would cancel it entirely, leaving the voltage across R3 at zero. But if that were the case, there would no longer be any voltage on the grid of V2, so that the canceling voltage supplied by the plate of V2 would disappear and R3 would again have a positive voltage across it.

A little thought will show just what actually happens. The voltage across R3 always reaches a point of equilibrium at which it is sufficient and of the proper polarity to maintain approximately equal voltages (with opposing

*Audio Consultant, New York City

**It's New! 3 Years in Development
-NOW READY FOR YOU!**

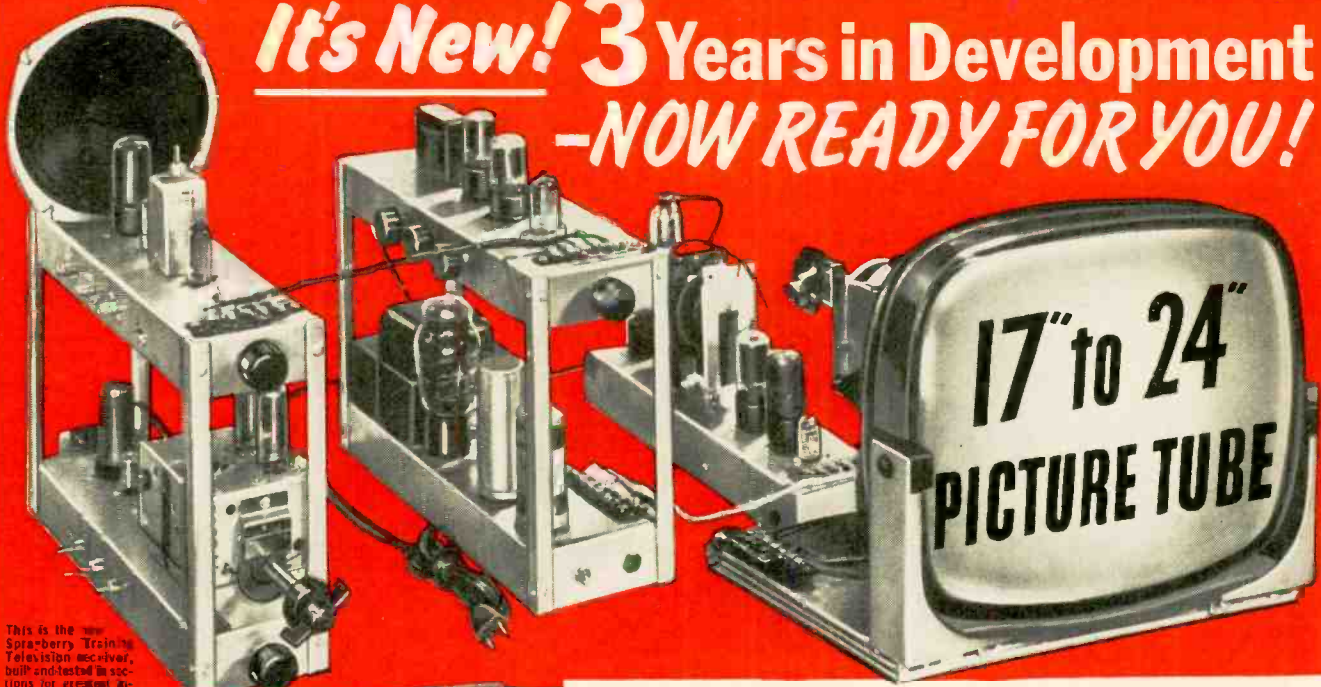

This is the new Sprayberry Training Television receiver, built and tested in sections for greatest instruction value.

**17" to 24"
PICTURE TUBE**

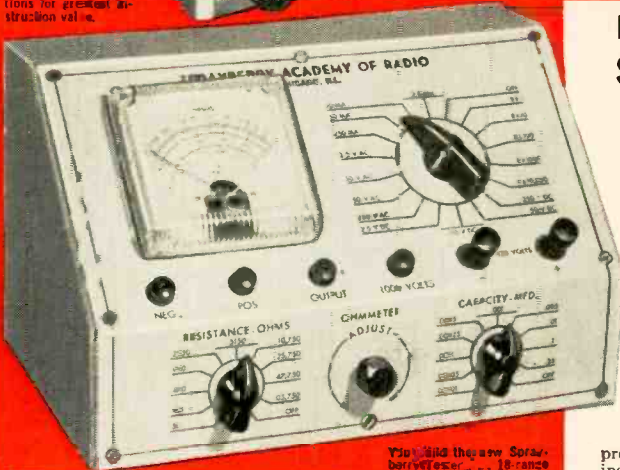

These photos show only a small part of the training equipment I send my students.

You will build the new Sprayberry Tester... 18-range Volt-Ohm-Milliammeter readings plus output meter and condenser and resistor substitution selector.

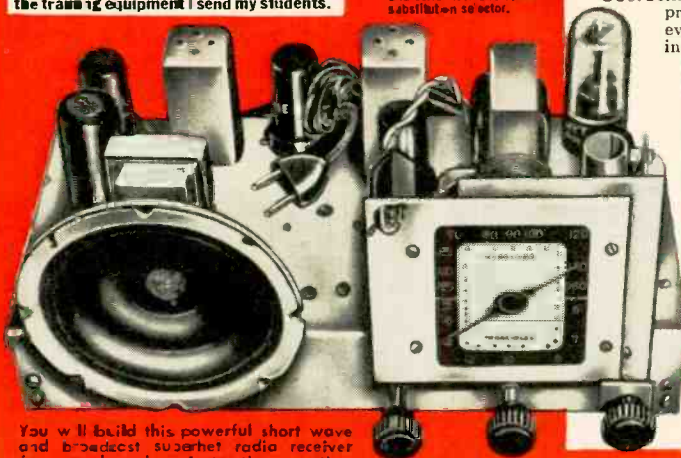

You will build this powerful short wave and broadcast superhet radio receiver for valuable shop instruction practice.

**New Equipment! New Lessons! Enlarged Course!
SPRAYBERRY PRACTICAL TRAINING IN
RADIO-TELEVISION
3 NO OBLIGATION TRAINING PLANS**



Frank L. Sprayberry
President, Sprayberry
Academy of Radio

**You have NO MONTHLY PAYMENT CONTRACT to sign
... pay for this outstanding training as you learn!**

The complete facts are so big and so important to any man seeking training in Radio-Television that I urge you to mail the coupon below at once for my big all-new 56 page FREE CATALOG and FREE Sample Lesson. Get the full story of this remarkable new and up-to-the-second Training Plan. You'll read about my 3 NO OBLIGATION PLANS or "packaged unit" instruction for both beginners and the experienced man. You'll learn how I can now prepare you in as little as 10 MONTHS to take your place in this fast moving big money industry as a Trained Radio-Television Technician. You'll see that you take no risk in enrolling for my Training because you DO NOT SIGN A BINDING TIME PAYMENT CONTRACT. I have been training successful Radio-TV technicians for 22 years... I can prepare you, too, to get into your own profitable Service Shop or a good paying job, even if you have no knowledge of Radio-Television. Mail the coupon... I rush full information FREE and without obligation. (No salesman will call.)

NEWEST DEVELOPMENTS

Your training covers
U H F, Color
Television, FM,
Oscilloscope
Servicing, High
Fidelity Sound
and Transistors.

**PRACTICE AND TRAIN AT HOME
WITH 25 NEW KITS OF EQUIPMENT**

You get valuable practical experience in construction, testing and shop practice. You build a powerful 2 band superhet radio, the all-new 18 range Sprayberry multimeter, the new Sprayberry Training Television receiver, signal generator, signal tracer and many other projects. All equipment is yours to use and keep... and you have practically everything needed to set up a Radio-Television Service Shop.

All your training is IN YOUR HOME in spare hours. Keep on with your present job and income while learning. I help you earn extra spare time money while you learn. If you expect to be in the armed forces later, there is no better preparation than practical Sprayberry Radio-Television training. Rush coupon below for all the facts—FREE!

SPRAYBERRY ACADEMY OF RADIO
111 NORTH CANAL STREET, DEPT. 20-L, CHICAGO 6, ILLINOIS

**FREE CATALOG AND
SAMPLE LESSON**

I rush coupon for my catalog "How to Make Money in Radio-Television". PLUS an actual sample Sprayberry Lesson without obligation—ALL FREE. Mail coupon NOW!

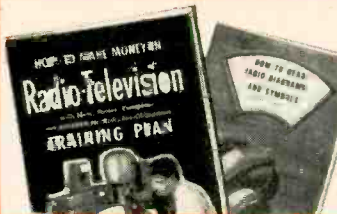

SPRAYBERRY ACADEMY OF RADIO MAIL THIS COUPON FOR FREE
Dept. 20-L, 111 N. Canal St., Chicago 6, Ill. FACTS AND SAMPLE LESSON

Please rush all information on your ALL-NEW Radio-Television Training Plan. I understand this does not obligate me and that no salesman will call upon me. Include New Catalog and Sample Lesson FREE.

Name _____ Age _____

Address _____

City _____ Zone _____ State _____

AUDIO—HIGH FIDELITY

phase) across both R1 and R2, which are of equal resistance. However the R1 and R2 voltages can never be precisely equal; if they were, the voltages across R3 would cancel and no voltage would be available to drive the V2 grid and create the necessary voltage across R2.

This is a simple and interesting example of a principle which is common to all self-correcting or self-compensating systems. In each case an error is detected and the error itself is used to make the correction—the correction is proportional to the error. The principle is: Correction or compensation can never be perfect, because without any remaining error there is nothing to stimulate the correction mechanism. The degree of compensation achieved depends on the gain of the correcting system, since with higher gain less remaining error is required to keep compensation in force.

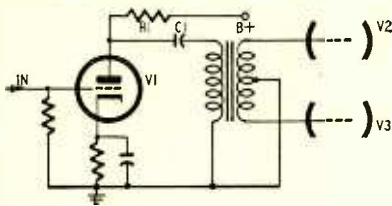

Fig. 2—Shunt-fed driver transformer.

This principle can be applied very easily to the circuit of Fig. 3. If V2 has high gain, a smaller grid voltage obtained from across R3 is sufficient to cause enough V2 output to bring about the equilibrium condition. Since the net voltage across R3 represents the unbalance between the output-stage grids, this means smaller unbalance. Obviously the whole situation is not affected in the least by the question of similarity between V1 and V2, which is untrue for most multistage phase splitters. The quality of this circuit, from a balance standpoint, depends wholly on the gain of V2, if we assume R1 and R2 to be equal in value.

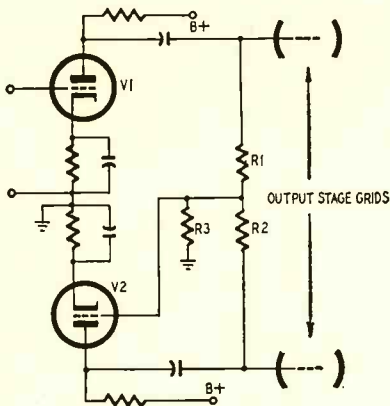

Fig. 3—Self-balancing phase splitter.

Unfortunately, this circuit is still not the ideal answer. Any triode operated with gain greater than 1 is subject to Miller effect, a multiplication in effec-

tive tube input capacitance proportional to the gain of the stage. The result is a decrease in high-frequency response. The signal in the Fig. 3 circuit goes through two such stages, so that the same objection applies as with the circuit given last month. The signal reaching one output grid has gone through a single triode, while that reaching the other has gone through two. The self-balancing action is some help but does not cure the situation entirely.

Cathodyne circuit

The phase splitter shown in Fig. 4 is a very satisfactory circuit both in performance and simplicity. The actual circuit shown is that used in the Radio Craftsmen type 400 amplifier (see photo on page 62). Only a single tube (V1) is used, and changes in its characteristics do not affect the balance. Only two resistors, R1 and R2, need to be matched.

The cathodyne (split-load circuit) is a combination cathode-follower and plate-loaded amplifier. Ignoring for a moment the grid circuit of V1, note that the plate and cathode resistors R1 and R2 have equal values. Thus, the same d.c. and signal currents must flow through both R1 and R2. Since current flows in the same direction through both resistors, polarity is always the same at the top of both resistors with respect to the bottom (and *vice versa*). The bottom of R2 is grounded directly. The top of R1 is grounded through the power-supply filter capacitor. Output is taken from the lower end of R1 and the upper end of R2. Therefore, the output voltages are 180° out of phase. The output voltages are equal in amplitude, since the same plate current creates identical voltage drops across the two identical resistors.

The last statement should be qualified. The impedance of the cathode output circuit is not actually equal to that of the plate output circuit. This is because impedance is a complex value composed not only of d.c. resistance but also of reactance. As we discussed last month in relation to the cathode follower, the a.c. impedance of a cathode circuit is almost never higher than about 500 to 600 ohms because of degenerative action. While the output voltage for the circuit of Fig. 4 can be computed simply by using Ohm's law to find the IR drop across R2, the impedance seen by the V3 grid is much lower than R2. As a result, the normal cathode-ground capacitance of the tube has little effect on the high-frequency response, being swamped by the effective low resistance.

The same is not true in the plate circuit. The actual output impedance there is composed of R1, the tube's plate resistance, and the tube's normal output capacitance. Both R1 and the plate resistance are relatively high (in relation to the cathode impedance), so the capacitance is not swamped so effectively. Due to the capacitance, the

voltage appearing across R1 is not as large as that across R2 and is not quite 180° out of phase with it.

The degree of unbalance caused by this situation depends primarily on the value chosen for R1 and R2 (though a low-output-capacitance tube helps reduce it). The lower the resistance values, the smaller the unbalancing effect of the complex plate impedance—but the lower, also, the undistorted output voltage capability. This drawback of the cathodyne circuit scared away many purists when high-fidelity began to blossom in a big way. However, it was found more recently that it is entirely possible to select values for R1 and R2 which would allow high enough output voltages, yet were small enough to swamp the capacitance to the point where high-frequency unbalance is not of any real importance. As a result there has been a swing back to the cathodyne.

One other problem with the cathodyne is the unusually large cathode resistor which causes a high d.c. voltage drop between cathode and ground. In the Craftsmen circuit of Fig. 4 this is 80 volts. If the grid resistor were grounded this would be a 80-volt bias, far too high a value for correct tube operation. One simple answer, used by this manufacturer (and in the original Williamson amplifier) is to place a 75-volt positive potential on the grid by directly coupling the plate of the previous tube to the grid of V1. Because of the 220,000-ohm plate resistor of the previous tube, its plate voltage is 75. R3 and C1 are used to provide a small amount of phase-shift compensation in the amplifier.

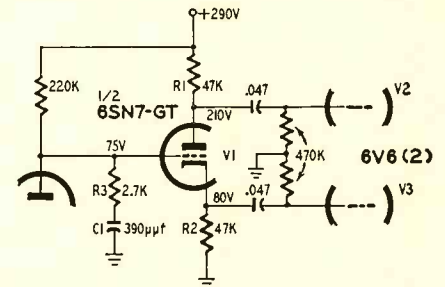
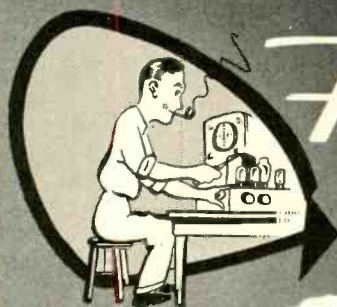

Fig. 4—Split-load phase splitter.

There are other methods of securing correct bias in common use. One is to ground the cathodyne grid as usual though a large-value resistor, then place another large-value resistor between the B supply and grid. The two act as a voltage divider and are so proportioned that the correct positive voltage appears on the grid. Another approach is to place the bottom of the grid resistor at some point along the cathode resistor rather than at ground, choosing the point to maintain correct grid-cathode voltage. It is also possible to insert a second cathode resistor between R2 (Fig. 4) and cathode, proportioned for correct bias. This new resistor is bypassed for a.c. and the lower end of the grid resistor is placed at the top of R2. (TO BE CONTINUED)

BUILD YOUR OWN

Heathkits



- TEST INSTRUMENTS
- AMPLIFIERS
- RECEIVERS, etc.

- ① Save by ordering direct from manufacturer.
- ② All high quality standard brand components.
- ③ Increased knowledge through actual construction.
- ④ Sound engineering insures excellent performance.
- ⑤ Kit construction is fascinating and enjoyable.



MODEL O-9
\$59.50
 Shipping Wt. 28 lbs.

Heathkit MODEL O-9

OSCILLOSCOPE KIT

New features unheard of in a kit oscilloscope have been added to the already popular Heathkit series. All top quality components are used including a brand new RCA 5UP1 CRT. Ten other first line tubes complete the lineup. Voltage regulation provides a rock steady pattern regardless of normal line voltage variations. A built-in blanking amplifier eliminates the retrace line entirely. Other important advantages are a phasing control, Z axis input, direct connections to the deflection plates, 1 volt peak-to-peak calibration voltage and a calibrated grid screen.

Wiring is simplified by the use of the harness technique which also results in a neat professional appearance. Extremely wide vertical bandwidth allows accurate reproduction of even a 500 KC square wave. Excellent focusing characteristics are made possible by the use of the new RCA 5UP1 CRT and a spot shape control. One of the most versatile of test instruments, the Heathkit O-9 Oscilloscope will be invaluable in the radio and TV service shop, as a work project in schools and for all types of circuit investigation work in the laboratory. Its new features make Model O-9 comparable in every way to many commercially built oscilloscopes selling for as much as \$400. Don't pass up this opportunity to add a really fine instrument to your service or experimental lab.

Heathkit

VOLTAGE CALIBRATOR KIT

The use of a Voltage Calibrator will greatly increase oscilloscope usefulness. Provides a convenient method of making peak to peak voltage measurements by establishing a relationship between the unknown wave shape and the Voltage Calibrator. Voltage ranges .01-100 volts peak to peak. The Voltage Calibrator features direct reading scales and a regulated power supply system.



MODEL VC-2
\$11.50
 Shipping Wt. 4 lbs.

Heathkit

ELECTRONIC SWITCH KIT

The Heathkit Electronic Switch Kit will further extend scope usefulness by permitting simultaneous observation of two individually controlled traces. Continuously variable switching rates 10 cps to 2,000 cps in three ranges. Will also serve as a square wave generator over the range of switching frequencies.



MODEL S-2
\$23.50
 Shipping Wt. 11 lbs.

Heathkit VACUUM TUBE VOLTMETER KIT

The beautiful new 1953 Heathkit Model V-6 VTVM, the world's most popular kit instrument, now offers many outstanding new features in addition to retaining all of the refinements developed and proven through the production of over 70,000 VTVM kits. The Heathkit VTVM now features extended voltage ranges with 50% greater coverage on the DC range. New 1 1/2 volt low scale provides well over 2 1/4 inches of scale length per volt permitting faster measurements with greater accuracy. AC and DC ranges are 0-1.5-5-15-50-150-500-1500 volts (1,000 volts maximum on AC). Ohmmeter ranges are X1, X10, X100, X1,000, X10K, X100K X1 meg. Measures .1 ohm to 1,000 megohms. Other features are db scale, center scale zero adjust and polarity reversal switch. High 11 megohm input resistance virtually eliminates circuit loading.

The low anti-inflation price of this tremendously popular kit includes all tubes, necessary constructional material, test leads and the construction manual.

MODEL V-6
\$24.50
 Shipping Wt. 6 lbs.



Heathkit AC VACUUM TUBE VOLTMETER KIT



MODEL AV-2
\$29.50
 Shipping Wt. 5 lbs.

A new amplifier type AC VTVM that makes possible those sensitive measurements so essential in laboratory or audio work. Ten voltage ranges covering from .01 RMS full scale to 300 volts RMS full scale. Input impedance 1 megohm with frequency response 20-50,000 cycles. Ten DB ranges from -52 to +52 DB. Four diodes in meter bridge circuit for maximum linearity.

Heathkit

HANDITESTER KIT



MODEL M-1
\$14.50
 Shipping Wt. 3 lbs.

The ever popular Handitester is now supplied with a Simpson 400 microampere meter movement. Provides AC and DC voltage ranges 0-10-30-300-1,000-5,000 volts. Ohmmeter ranges 0-3,000 and 0-300,000 ohms. DC current measurements 0-10 and 0-100 milliamperes. A completely self contained portable instrument.

HEATH COMPANY • Benton Harbor 20, Mich.

HEATHKITS for the ENGINEER

Heathkit VISUAL AURAL SIGNAL TRACER KIT



MODEL T-3 \$23⁵⁰

Shipping
Wt. 10 lbs.

Designed especially for service applications in AM-SW-FM-TV repair work, RF and audio two channel input. More than adequate sensitivity—new noise locator circuit—calibrated wattmeter—substitution speaker—visual signal indication. Can be used with scope and VTVM, checks phono cartridges, phono mechanisms, microphones, tuners, etc. Let the Heathkit Visual Aural Signal Tracer help you.

Heathkit CONDENSER CHECKER KIT

An instrument designed solely for its particular job. Not a "sideline" or a multiple function instrument. Measures value and quality of unknown condensers and resistors. Capacity range .00001 mfd to 1,000 mfd. Resistance range 100 ohms to 5 megohms. Sensitive electron beam indicator—five polarizing test voltages—safety spring return leakage test switch. An amazingly accurate instrument at this low price.



MODEL C-3
\$19⁵⁰ Shipping
Wt. 8 lbs.

Heathkit SIGNAL GENERATOR KIT



MODEL SG-8
\$19⁵⁰

Ship. Wt. 8 lbs.

The standard service instrument for alignment work. 1 volt output from 160 KC to 110 MC. Calibrated harmonics up to 220 MC. Internal (400 CPS) and external modulation. Pre-calibrated coils for all 5 bands. Good stability and accuracy. All test leads included.

Heathkit LABORATORY REGULATED POWER SUPPLY KIT



MODEL PS-2
\$33⁵⁰

Ship. Wt. 20 lbs.

A regulated variable 160-450 volt DC output power supply for the lab or service shop. Accurate voltage and current measurements with large Simpson meter. AC supply 6.3 volts at 4 amperes—standby switch eliminates warmup time. Low hum content—5 tube circuit. AC and DC output voltages isolated from panel for maximum operational flexibility.

Heathkit RESISTANCE SUBSTITUTION BOX KIT

MODEL RS-1

Ship. Wt. \$5⁵⁰
2 lbs.



Choice of 36 switch selected resistance values 15 ohms to 10 megohms. All standard RTMA 1 watt 10% resistors. Buy several for those lab and service applications.

NEW Heathkit 20,000 OHMS PER VOLT MULTIMETER KIT

Here is the solution to all service problems requiring a portable measuring device of high accuracy. 20,000 ohms/volt sensitivity on DC and 5000 ohms/volt on AC. Full scale voltage ranges of 1.5, 5, 50, 150, 500, 1500 and 5000. DC current ranges of 150 microamperes; 15, 150 and 750 milliamperes; and 15 amperes. Resistances are measured from .2 ohms to 20 megohms in 3 ranges and decibels from -10 to +65 db.

Model MM-1 uses standard commercially available batteries and is not affected by strong RF fields as encountered in and near transmitting equipment. 1% precision resistors on a very easily wired ring type range switch and a highly accurate Simpson 50 microampere meter fully qualifies the Heathkit Multimeter for close tolerance laboratory and service work. The meter movement is placed in a recessed position for maximum non-glare readability. The kit includes the attractive black bakelite cabinet, 2 color meter scales, test leads, batteries and all other necessary components. Overall cabinet size is 5 1/4" wide x 4" deep x 7 1/2" high.



MODEL MM-1
\$26⁵⁰
Ship. Wt. 6 lbs.

Heathkit GRID DIP METER KIT

One hand operation. 5 pre-wound coils cover 2-250 MC. Controlled sensitivity. Usable as an oscillator or an absorption wavemeter. Extra low frequency coils available.



MODEL GD-1B
\$19⁵⁰
Ship. Wt. 4 lbs.

Heathkit TUBE CHECKER KIT



MODEL TC-2
\$29⁵⁰

Shipping Wt. 12 lbs.

Checks overall tube quality, filament continuity, and individual elements for shorts and opens. Features chart illumination, harness type wiring, and large 3-color meter scale.

Portable Model TC-2P at \$34.50. Wt. 14 lbs. No. 91-8 Cabinet only at \$7.50. Wt. 7 lbs. No. 355 TV Picture Tube Adapter at \$4.50. Wt. 1 lb.

Heathkit LABORATORY GENERATOR KIT



MODEL LG-1
Ship. Wt. \$39⁵⁰
16 lbs.

A professional laboratory instrument designed for extreme accuracy in frequency and output level. Colpitts oscillator operates in 5 ranges from 150 KC to 30 MC. Panel meter calibrated in output voltage and percent of modulation. Output in excess of 1 volts. Features complete shielding of oscillator, buffer and attenuator sections; regulated power supply and 50 ohm output cable. Comparable instruments priced many times higher than the cost of this new kit.

Heathkit AUDIO WATTMETER KIT



MODEL AW-1
Ship. Wt. \$29⁵⁰
6 lbs.

Measure output power levels directly with the Heathkit Audio Wattmeter. Flat response to frequencies from 10 CPS to 250 KC. Full scale ranges of 5 MW, 50 MW, 500 MW, 5 W and 50 W. Db calibration from -10 to +48. Uses non-inductive built-in load resistors providing impedances of 4, 8, 16 and 600 ohms. Meter bridge uses 4 germanium diodes.

HEATH COMPANY • Benton Harbor 20, Mich.

SERVICEMAN • AMATEUR • STUDENT

Heathkit IMPEDANCE BRIDGE KIT

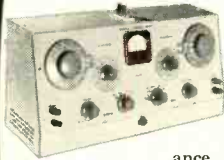

MODEL 1B-2
\$59⁵⁰
Ship. Wt. 15 lbs.

Modern design with built-in 1 KC generator for AC measurements. A choice of the Wheatstone, Maxwell, Hay or capacitance comparison bridges for measuring resistance, capacitance, inductance, dissipation factor and storage factor. 1/2% resistors and precision mica condensers provide maximum accuracy. Completely AC operated.

Heathkit DECADE RESISTANCE KIT



MODEL DR-1
\$19⁵⁰

Ship. Wt.
4 lbs.

Individual switch selection of twenty 1% precision resistors in 1 ohm steps from 1 to 99,999 ohms. Sturdy ceramic wafer switches featuring silver plated contacts and smooth, positive detent action.

Heathkit TELEVISION SWEEP GENERATOR KIT



MODEL TS-3
\$44⁵⁰

Ship. Wt. 18 lbs.

Simplify your TV alignment jobs with the new Heathkit TS-3. Full coverage on fundamentals from 4 MC to 220 MC at an output of well over 100,000 microvolts . . . Automatic blanking and wide range phasing. A triple marker system ranges from 19 MC to 180 MC using a Colpitts oscillator plus the 4.5 MC crystal controlled oscillator for check points (crystal furnished). Provisions are also made for using an external marker.

Featured is the new sweep system, using an *INCREDUCTOR controllable inductor. Sweep width is variable from 0 to 12 MC at the lower RF frequencies and increases to 0-50 MC at the highest . . . Other advantages are power supply regulation, constant RF output level, independent marker and RF output control circuits, low impedance output and properly terminated output cables. The construction manual is complete in all detail and with a reasonable amount of care, Model TS-3 will serve faithfully for many years to come.

*Trademark, C.G.S. Laboratories, Stamford, Connecticut

Heathkit COMMUNICATIONS RECEIVER KIT



MODEL AR-2
\$25⁵⁰
Ship. Wt. 12 lbs.
(Less Cabinet)

Full coverage from 550 KC to 35 MC on 4 bands, with good sensitivity and selectivity. Features electrical handspread, BFO, headphone jack, slide rule dial with ham band identification, RF gain control, noise limiter and phone-standby-CW switch. Top quality, high gain components used throughout. Pre-wound coils in a shielded turret assembly and a transformer operated power supply assure trouble-free performance.

Cabinet available separately. No. 91-10. Shipping wt. 5 lbs. Price \$4.50.

Heathkit Q METER KIT

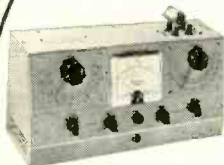

MODEL QM-1
\$44⁵⁰ Ship. Wt. 14 lbs.

A typical Heathkit invasion of the laboratory instrument field. Here is the first successful low priced Q meter ever offered in kit form. Oscillator supplies RF in the range of 150 KC to 18 mc. Reads Q directly on calibrated meter scales. Measures Q of condensers, RF resistance and distributed capacity of coils. Calibrate capacitor with range of 40 mmf to 450 mmf with vernier ± 3 mmf. All measurements made at the operating frequency.

Heathkit AUDIO OSCILLATOR KIT

MODEL AO-1
\$24⁵⁰
Ship. Wt. 11 lbs.



Features sine or square wave coverage from 20-20,000 cycles in 3 ranges. Variable 10 volt output level at 600 ohms impedance. Thermistor controlled linearity—precision multiplier resistors—distortion less than .6%. An outstanding instrument value at this amazing low price.

Heathkit AMATEUR TRANSMITTER KIT



MODEL AT-1
\$29⁵⁰
Ship. Wt. 16 lbs.

Power input up to 35 watts on 80, 40, 20, 15, 11 and 10 meters. Can be crystal or VFO excited. Complete with modulator input socket and VFO power output provisions. Other desirable features are good shielding, AC line filter, key click filter, standby switch and a 52 ohm coaxial output. Model AT-1 is AC operated and is suitable as an exciter for a higher powered rig. Complete with full instructions for construction and use.

Heathkit DECADE CONDENSER KIT

Switch selected 1% silver mica precision condensers providing capacity range of 100 mmf. to 0.111 mfd. in steps of 100 mmf.

MODEL DC-1
\$16⁵⁰

Shipping Wt. 4 lbs.



Heathkit AUDIO GENERATOR KIT

A new extended range 18 cycles—1 megacycle audio instrument at a remarkably low price. Five continuously variable output ranges—600 ohm output impedance—low distortion figure, less than .4% from 100 cps through audible range.



MODEL AG-8
\$29⁵⁰
Ship. Wt. 11 lbs.

Heathkit BAR GENERATOR KIT



Small, compact and easy to use, Model BG-1 supplies horizontal or vertical bars for TV linearity adjustments. Output cable clips directly to the TV receiver antenna terminals.

MODEL BG-1
Ship. Wt. 6 lbs. **\$14⁵⁰**

Heathkit BATTERY ELIMINATOR KIT

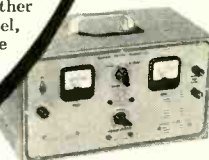

MODEL BE-4
Ship. Wt. 18 lbs. **\$31⁵⁰**

6 or 12 volt operation with current and voltage constantly monitored. Double protection with a fused transformer and automatic overload relay. Well filtered output and all heavy duty components. Designed for auto radio repair and as a storage battery charger.

WRITE FOR Free CATALOG

New 40 page 1954 Catalog lists all kits, specifications, schematics and latest price information.

HEATH COMPANY • Benton Harbor 20, Mich.

Heathkit FM TUNER KIT



MODEL FM-2
\$22.50

Shipping Wt. 9 lbs.

Sensitive transformer operated 8 tube circuit. Frequency coverage 88-108 mc. Pre-assembled and tuned "front end." Vernier tuning with slide rule type dial.

NEW Heathkit BROADCAST BAND RECEIVER KIT



MODEL BR-2
\$17.50

(Less Cabinet)
Ship. Wt. 11 lbs.

Complete receiver with chassis mounted 5 1/4" PM Speaker and new rod type antenna. Covers the full broadcast band (550 KC-1600 KC) with excellent sensitivity and selectivity. Operates as a receiver, tuner or a phono amplifier. High gain miniature tubes and IF transformers. Easy tuning with direct planetary drive.

Cabinet available separately. Part No. 91-9. Ship. wt. 5 lbs. Price \$4.50.



Heathkit LOW PRICED Single UNIT WILLIAMSON TYPE AMPLIFIER KIT

MODEL W-4M

\$39.75

Ship. Wt. 28 lbs.

The famous Heathkit Williamson Type Amplifier is now available in a single chassis. Includes power supply and power amplifier. Enjoy the same high quality reproduction at less cost by eliminating the second chassis, connecting cables, etc. Size 15 1/4" wide—7" high—9" deep. Model W-4 includes W-4M and preamplifier WA-P2. Shipping weight 35 lbs. Price \$59.50.

NEW HEATHKIT WILLIAMSON TYPE AMPLIFIER KIT

The ideal amplifier for custom high fidelity audio installations. Tops in performance, value and flexibility of operation. Either Altec Lansing Peerless or Acrosound output transformers available. Frequency response ± 1 db 10 CPS to 100 KC, negligible hum and noise levels and plenty of reserve power for complete listening pleasure. First Williamson Type Amplifier supplied with matching preamplifier.

PRICES OF VARIOUS COMBINATIONS:

W-2 Amplifier Kit (Includes Main Amplifier with Peerless Output Transformer, Power Supply and WA-P2 Preamplifier.) Shipping weight 38 lbs. Shipped express only **\$69.50**

W-2M Amplifier Kit (Includes Main Amplifier with Peerless Output Transformer and Power Supply.) Shipping weight 30 lbs. Shipped express only..... **\$49.75**

W-3 Amplifier Kit (Includes Main Amplifier with Acrosound Output Transformer, Power Supply and WA-P2 Preamplifier.) Shipping weight 38 lbs. Shipped express only **\$69.50**

W-3M Amplifier Kit (Includes Main Amplifier with Acrosound Output Transformer and Power Supply.) Shipping weight 30 lbs. Shipped express only..... **\$49.75**

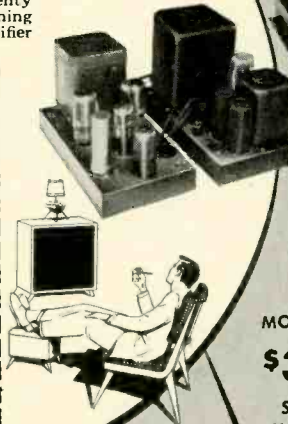

Heathkit ECONOMY 6 WATT AMPLIFIER KIT

MODEL A-7B
\$15.50

Ship. Wt. 10 lbs.

Dual inputs—separate bass and treble tone controls—output impedances of 4, 8, and 15 ohms. Performance far beyond that normally expected for the price. A-7C: Includes preamplifier for low level input devices. Price \$17.50

Heathkit HIGH FIDELITY 20 WATT AMPLIFIER KIT

MODEL A-9B

\$35.50

Shipping Wt. 23 lbs.



Outstanding features of the Heathkit 20 Watt Amplifier include a frequency response of ± 1 db from 20 CPS to 20 KC, less than 1% harmonic distortion at rated output, separate (boost and cut) bass and treble tone controls, 4 selected input jacks, hum balancing control and output impedances of 4, 8, 16 and 500 ohms. Flexibility is emphasized in the input circuits with built-in preamplifier and proper equalization.

HEATHKIT HIGH FIDELITY PREAMPLIFIER KIT

MODEL WA-P2

\$19.75

Ship. Wt. 7 lbs.

Complete compensation for LP, NARTB, AES and early 78 recording characteristics. An ideal control unit for the custom Hi-Fi system. 5 individually controlled inputs, 4 turnover and roll-off switch positions, 3 twin triode tubes, cathode follower output, monitored recorder output, shock mounted tube chassis and proper shielding. All condensers are of the molded plastic type. Critical input circuits feature low noise deposited carbon resistors. Use it with any conventional high fidelity amplifier.



HEATH COMPANY • Benton Harbor 20, Mich.

ORDER BLANK



MAIL YOUR ORDER TODAY TO THE
HEATH COMPANY
BENTON HARBOR 20,
MICHIGAN

From _____

(PLEASE PRINT) _____

SHIP VIA

- Parcel Post
- Express
- Freight
- Best Way

QUANTITY	ITEM	MODEL NO.	PRICE

Enclosed find () check () money order for _____ pounds.
Please ship C.O.D. () postage enclosed for _____

On Express orders do not include transportation charges—they will be collected by the express agency at time of delivery.

ON PARCEL POST ORDERS insure postage for weight shown. ORDERS FROM CANADA and APO's must include full remittance.

Servicing

High-Fidelity Equipment

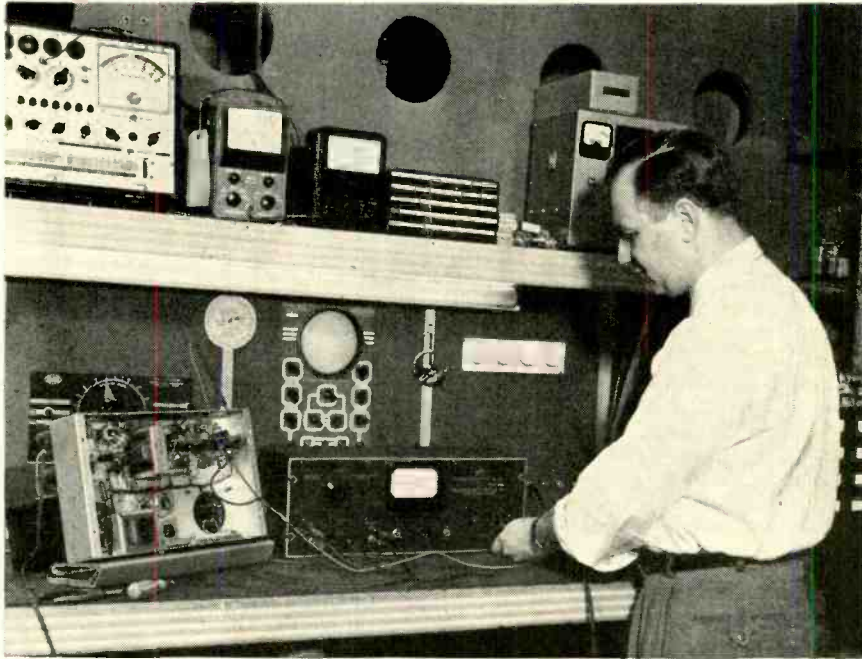

Courtesy Arrow Electronics Audio Center, New York City

Measuring intermodulation on a well equipped bench for audio servicing.

By JOSEPH MARSHALL

Part V—Using the IM

analyzer; checking feedback

loops; effectively

diagnosing audio

distortion measurements

MEASUREMENT and testing routines for the servicing of high-fidelity equipment differ from those used in development and production work. Whereas the laboratory or production test bench is interested in how closely equipment meets ideal or desired specifications, the service technician is interested in discovering how and why the equipment departs from specifications, and discovering this in the quickest, most labor-saving way. His problem is not actually measurement but diagnosis. This magazine and others have many times covered the various measurement methods applicable to audio systems, and I shall try not to go over the same ground, but instead to concentrate on describing ways in which these methods may be more effectively used and combined for rapid servicing.

We won't spend time discussing the problems presented by a hi-fi system when it simply stops completely and utters no sound at all. The real headaches in high-fidelity servicing come from equipment with higher than normal distortion; and it is here that ef-

fective routines are most often needed.

Procedure

Let us suppose that you have visited the installation and have decided that the high distortion is being produced in the main amplifier. You have removed the offending unit from its place in a clothes closet and have brought it to your shop. Now you're ready to find out what's ailing it and where. If you have no specialized instruments, you can use a signal provided by a record, a radio, or your test generator, and headphones or a v.t.v.m. for indication. But we will assume you are equipped with some or all of the following: IM analyzer, signal generator, scope, a.c. v.t.v.m. and wattmeter.

The first step is to find out how bad the situation is. This is most quickly and accurately determined with an IM analyzer. Provide a load for the amplifier. If you have a wattmeter it will provide the load as well as output indication. If you do not have one, use a 20-watt resistor of 8 or 15 ohms. A 15-ohm adjustable 20-watt resistor with the slider set half-way, is very useful for this purpose. Measure the IM for levels of 0.1, 1.0 and 10 watts.

If you have a wattmeter you can read the output on it. (Keep in mind that for two-frequency signals in a ratio of 4 to 1, the actual r.m.s. power output, equivalent to that of a single frequency, will be about 1½ times the meter reading.) If you do not have a wattmeter, set the volume control until you obtain the following voltages as indicated on the IM analyzer meter when it is used as a voltmeter. These voltages apply to the composite 60- and 3000- (or 7000-) cycle signal in a ratio of 4 to 1.

Load Resistance	Watts	Volts
8 ohms	0.1	0.69
8 ohms	1.0	2.2
8 ohms	10.0	6.9
16 ohms	0.1	0.95
16 ohms	1.0	2.8
16 ohms	10.0	9.5

Compare the IM readings you get with those of the specifications for the amplifier in question. Most high-fidelity amplifiers specify 2% IM or less at 10 watts; and a fraction of 1% at 0.1 watt. Published distortion figures on commercial amplifiers are usually an averaged value, based on production sampling. Any given amplifier may de-

AUDIO—HIGH FIDELITY

part from the average figure and still be within the manufacturer's acceptable tolerance range. Few manufacturers publish their tolerance figures. Your reading may be anything from these figures up to and exceeding 30%. The higher the distortion level, in general, the easier it is going to be for you to find the trouble. If the figure is only slightly off, say only twice as high as specified, you are well advised to stop, think, and decide whether you ought to spend any more time at all on it.

In the latter case I would check the balance of the output tubes and adjust it if there is a balancing control, or try a new pair of tubes to find a better-balanced pair. If this does not bring the IM down close to specs, I would try changing the other tubes, especially the rectifier. If this tube has too high an internal voltage drop, it may be disturbing the operating curve of one or more tubes and causing abnormal distortion. If, after this, the IM is reasonably close to the specified value, I would ask myself if I didn't make a mistake in tracing trouble at the installation. Unless your ears are very sharp and well accustomed to judging distortion, it is very unlikely that you could discern the difference between 2% or even 4% IM and less; and the same goes for your customer. If you heard distortion plainly in testing, but found not more than 5% IM on measuring, chances are very high that the trouble lies in the preamp, control unit, tuner, or even the turntable. And there is little point in doing much more work on the amplifier, since it is certainly

going to be troublesome to reduce the remaining distortion any further; and indeed may not be possible at all without going to such extremes as changing plate and cathode resistors, etc. In any case, the audible difference, even with a speaker load, is going to be so small that the big bill you would have to present to your customer would probably not seem justified to him. Furthermore, unless you're a real expert, you may make matters worse.

Let us assume that you find more distortion than this, or that, in any case, you want to reduce it. The most effective procedure will be determined by the amount of distortion you find. If it is less than 10% at maximum rated output, your best bet will be to continue with the IM analyzer. In most cases you will find that a scope gives no significant information when the IM is less than 10 or 12%. IM distortion of course does not show up on sine waves; and amplitude or harmonic distortion does not show up clearly until it exceeds 3%, which usually means an IM of 10 or 12%. So when the IM analyzer shows less than 10 or 12%, the IM analyzer is by far the most effective diagnostic tool.

It may help, if the IM is less than 5%, to exaggerate the distortion. This can be done by adjusting the IM analyzer to deliver a mixed signal in a 1-1 ratio instead of the normal 4-1. In most cases this will at least double the indicated distortion.

Checking feedback loop

Having determined that the tubes are not the principal cause of the

trouble, and having obtained the best balance possible, the next step is to disconnect the feedback loop temporarily and take another IM measurement. The distortion should increase by a factor of from 2 to 10 when the loop is disconnected. (You must, of course, reduce signal input to bring the output back down to normal.) If distortion does not increase markedly, check the feedback loop for a shorted or open resistor or capacitor, if the loop uses one. You can check the capacitor easily with the IM signal and meter.

Feed the signal to one end of the capacitor, and measure the voltage at both ends. Since the reactance at 60 cycles may be considerable, you may get a reduction in reading at the output; but with any likely value of capacitance, say up to .05 μ f, the loss shouldn't be more than 3 db. If the loss is greater than this, the reactance is much too high—unless the feedback loop is meant to produce bass-boosting—and might be producing core saturation in the output transformer at a level much lower than normal. Production runs of capacitors may be off as much as plus 100% and minus 50%; and while it is very unlikely that a high-quality amplifier would have got by with so great a departure from specs, the capacitance might have changed through excess heat or humidity. The presence of a capacitor in the loop usually means that the loop starts at a point, like the plate of a tube, where d.c. voltages are present. Therefore, check the capacitor for leakage, which is likely to increase with age, overheating, etc.; even a little d.c. leakage may throw the stage to which feedback is applied into the curved portion of its operating range. The feedback resistor can be checked with an ohmmeter. A difference from specified or marked value of plus or minus 20% will not be significant ordinarily; but a wider difference, especially on the low side, might well be, and in that case I would replace it with one which is as close as possible to the exact specified value.

If the feedback loop checks all right, the next step is to see if it produces instability. Check the current of the output tubes with and without the feedback loop; if the current rises significantly when the loop is connected, you've got either outright oscillation or regeneration. First check the parasitic suppressors. These are resistors of between 30 and 1,000 ohms in series with the grids or plates, or both. Usually, too, when a tetrode is used as a triode, there is a resistor of between 100 and 1,000 ohms between the screen and plate. Check all of these for opens or shorts; moderate departures from specified values do not usually matter.

Further checks

The next step is to check the decoupling network. This consists of one

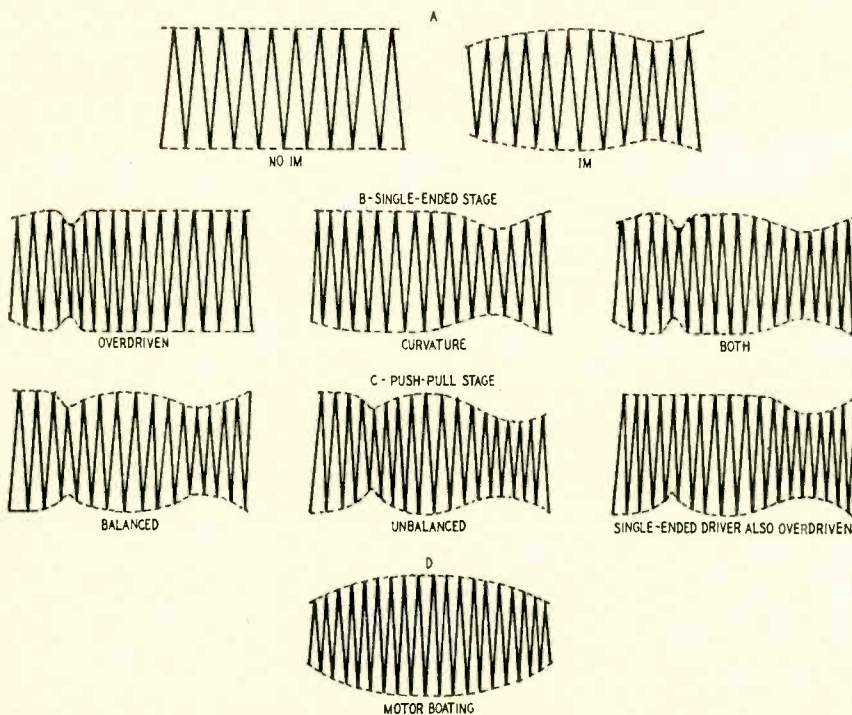

Fig. 1—Notches obtained as scope patterns enable rapid diagnosis.

or more resistors in series with the plates and the supply voltage, bypassed by electrolytics on one or both sides. This is also part of the hum-filtering network. Leakage may produce distortion by lowering the voltage, but does not harm the decoupling; so an open condition is what you want to look for. The simplest check is to take an electrolytic capacitor of around 20 to 40 μf , the larger the better, with a 400-volt rating; place it in parallel with each of the filter or decoupling capacitors in turn. If this causes the plate current to drop to normal, replace the faulty capacitor with one of the same or greater capacitance.

If this still hasn't solved the problem, and the output tubes are triodes or, as in the Williamson, tetrodes used as triodes, it will almost certainly do no harm to neutralize the output tubes. Most such tubes have plate to grid capacitances of between 10 and 20 μf . Wire in a pair of 10- or 15- μf fixed capacitors from the plate of one tube to the grid of the other and the same on the other side. You are quite unlikely to make matters worse, and very likely to clear up the instability. The exception may occur with some output transformers whose high-frequency resonance peak is below 50 kc. Neutralization doubles the output capacitance, and it is possible, but only faintly possible with modern transformers, that this doubled capacitance might increase the resonant peak and therefore the parasitics. I repeat, however, that this is quite unlikely but I point it out just in case it should happen.

If all this has not resulted in stability, your only remaining alternative is to reduce the feedback. Wire-in temporarily, in place of the feedback resistor, a potentiometer of 2 or 3 times greater value; adjust it until the plate current rises, then back it off until it falls to normal value. Sweep an audio generator from 20 cycles or less to 20 kc or more and check to see that the current does not rise at any frequency. If it does, back off the potentiometer some more until stability is once more obtained. Sweep again to make sure. This is now the maximum feedback the circuit will stand. You should get a considerable improvement of IM with the feedback loop connected. Now replace the potentiometer with a resistor equal in value to the used portion of the potentiometer, but in any case no greater resistance should be used.

Suppose the loop is stable but the IM continues high. Continue, with the loop disconnected, to make stage-by-stage analysis with the IM analyzer. If you equip the leads to the analyzer portion of the IM analyzer with insulated alligator clips, you can measure the IM in each stage and thus isolate the one in which the trouble is occurring. The analyzer does not permit balanced measurement of push-pull stages; you have to measure the IM on each side of a push-pull stage by moving the hot lead from one grid, or

plate, to the other. Keep in mind that measuring one side of a push-pull stage will give you a higher IM reading than actually exists at the output, because the cancellation due to push-pull operation in not indicated. However, this is all to the good, since the distortion is magnified and is therefore easier to follow and locate.

You should find a point at which the distortion falls markedly (if you trace from output to input) or rises markedly (if you trace from input to output). You will also get an excellent indication of unbalance since an unbalanced stage will give you a higher reading on one side than on the other side.

Having found this stage, check the voltages, etc., as outlined in the first article of this series (February, 1954) and make the corrections recommended. It is difficult to set standards for IM distortion in individual stages. Modern amplifiers with 20 db or more of feedback can tolerate considerable distortion in individual stages at or near maximum output. However, I would say that an IM of 5% for a single-ended stage will usually be reduced by feedback to less than 1%; and IM of 10% or even 15% per side in push-pull stages will be reduced by cancellation to less than 1%; such values are tolerable. When you have reduced the IM in the faulty stage to this or lower values, take another overall reading with the loop connected. Unless there is additional trouble, you should now get an acceptable IM level, and the remaining distortion can usually be lowered some more by careful rebalancing.

The above method cannot be improved upon for diagnosis of today's first-class equipment when the distortion is low but still above the specified amount. It will continue to give very sharp indications of trouble, long after all other methods have indicated that the equipment is as clean as a pure sine wave. It has a couple of faults, however. First, it is a static method. That is to say, you cannot get a continuous reading of the variation in IM; the readings are accurate only for a given fixed point. Second, although the indications of distortion are extremely sensitive, they give no clue as to the cause of the trouble, making diagnosis difficult.

Alternate method

There is a modification which corrects both faults, although at the expense of some sensitivity. I recommend it highly, nevertheless, for it makes diagnosis extremely rapid. This method requires a scope in addition to the IM analyzer. Also, it is necessary to get into the analyzer and provide an output terminal at the point where the signal enters the demodulator or comes out of the high-pass filter. In the Heathkit IM-1 this is very easy. A 1,000- μf mica capacitor is connected to terminal 1 of the 12AX7. This is the plate of the second amplifier. The

ATTENTION!!
Executives and Salesmen!

*Shave in the
Comfort of
Your Own Car,
Boat or Plane!*

WITH **ATR**

SHAV-PAK



Keep in
Glove
Compartment

Specially Designed for
Operating Standard A.C.
Electric Shavers in
Automobiles, Buses,
Trucks, Boats, and
Planes.



PLUGS INTO
CIGARETTE LIGHTER
RECEPTACLE
ON DASH

\$12.95

LIST PRICE

TYPE	INPUT D.C. VOLTS	A.C. OUTPUT 60 CYCLES	OUTPUT WATTAGE	LIST PRICE
6-SPB	6	115 volts	15	12.95
12-SPB	12	115	15	12.95

**DICTATE REPORTS
ACCURATELY-PROMPTLY!**

*make your car, boat or plane
a "rolling office"*

WITH **ATR**

INVERTERS



Plugs into
Cigarette Lighter
Receptacle on Dash

for changing your
storage battery
current to A. C.

Household
ELECTRICITY

Anywhere
in your own car!

\$2250
AND UP
LIST PRICE



ATR INVERTERS . . .

especially designed for operating
standard 110 volt A. C. . . .

- TAPE RECORDER
- WIRE RECORDERS
- DICTATING MACHINES
- ELECTRIC RAZORS

See your jobber or write factory today
for complete information



AMERICAN TELEVISION & RADIO
Quality Products Since 1931
SAINT PAUL 1, MINNESOTA - U. S. A.

NO INTEREST!!

Buy on our radically new
Time Payment Plan

NO CARRYING CHARGES!!



Superior's new
Model 670-A

SUPER METER

A COMBINATION VOLT-OHM MILLIAMMETER PLUS
CAPACITY REACTANCE INDUCTANCE AND DECIBEL MEASUREMENTS

SPECIFICATIONS:

D.C. VOLTS: 0 to 7.5/15/75/150/750/1,500/7,500 Volts
A.C. VOLTS: 0 to 15/30/150/300/1,500/3,000 Volts
OUTPUT VOLTS: 0 to 15/30/150/300/1,500/3,000 Volts
D.C. CURRENT: 0 to 1.5/15/150 Ma. 0 to 1.5/15 Amperes
RESISTANCE: 0 to 1,000/100,000 Ohms to 10 Megohms
CAPACITY: .001 to 1 Mfd. 1 to 50 Mfd. (Quality test for electrolytics)
REACTANCE: 50 to 2,500 Ohms 2,500 Ohms to 2.5 Megohms
INDUCTANCE: .15 to 7 Henries 7 to 7,000 Henries
DECIBELS: -6 to +18 +14 to +38 +34 to +58

ADDED FEATURE:

The Model 670-A includes a special **GOOD-BAD** scale for checking the quality of electrolytic condensers at a test potential of 150 Volts.

The Model 670-A comes housed, in a rugged crackle-finished steel cabinet complete with test leads and operating instructions.

\$2840
NET



Superior's new
Model TV-11

TUBE TESTER

SPECIFICATIONS:

- ★ Tests all tubes including 4, 5, 6, 7, Octal, Lock-in, Peanut, Bantam, Hearing Aid, Thyatron Miniatures, Sub-miniatures, Novals, Sub-minars, Proximity fuse types, etc.
- ★ Uses the new self-cleaning Lever Action Switches for individual element testing. Because all elements are numbered according to pin-number in the RMA base numbering system, the user can instantly identify which element is under test. Tubes having tapped filaments and tubes with filaments terminating in more than one pin are truly tested with the Model TV-11 as any of the pins may be placed in the neutral position when necessary.
- ★ The Model TV-11 does not use any combination type sockets. Instead individual sockets are used for each type of tube. Thus it is impossible

to damage a tube by inserting it in the wrong socket.

- ★ Free-moving built-in roll chart provides complete data for all tubes.
- ★ Newly designed Line Voltage Control compensates for variation of any Line Voltage between 105 Volts and 130 Volts.
- ★ **NOISE TEST:** Phono-jack on front panel for plugging in either phones or external amplifier will detect microphonic tubes or noise due to faulty elements and loose internal connections.

The model TV-11 operates on 105-130 Volt 60 Cycles A.C. Comes housed in a beautiful hand-rubbed oak cabinet complete with portable cover

EXTRA SERVICE—The Model TV-11 may be used as an extremely sensitive Condenser Leakage Checker. A relaxation

type oscillator incorporated in this model will detect leakages even when the frequency is one per minute.

\$4750
NET



Superior's New Model 660-A AN AC OPERATED
SIGNAL GENERATOR

PROVIDES COMPLETE COVERAGE for AM-FM & TV Alignment

SPECIFICATIONS:

- Generates Radio Frequencies from 100 Kilocycles to 60 Megacycles on fundamentals and from 60 Megacycles to 220 Megacycles on powerful harmonics.
- Accuracy and Stability are assured by the use of permeability trimmed Hi-Q coils.
- R.F. available separately or modulated by the internal audio oscillator.
- Built in 400 cycle sine wave audio oscillator used to modulate the R.F. signal also available separately for audio testing of receivers, amplifiers, hard of hearing aids, etc.
- R.F. Oscillator Circuit: A high transconductance

heptode is used as an R.F. oscillator, mixer and amplifier. Modulation is effected by electron coupling in the mixer section thus isolating the oscillator from load changes and affording high stability.
- A.F. Oscillator Circuit: A high transconductance heptode connected as a high- μ triode is used as an audio oscillator in a High- μ Colpitts Circuit. The output (over 1 Volt) is nearly pure sine wave.
- Attenuator: A 5 step ladder type of attenuator is used.

TUBES USED:

- 1-6BE6 as R.F. Oscillator, mixer and amplifier.
- 1-6BE6 as Audio Oscillator.
- 1-6H6 as Power Rectifier.

The Model 660-A comes complete with coaxial cable test lead and instructions.

\$4295
NET

MOSS ELECTRONIC DISTRIBUTING CO., INC.
Dept. B-105, 3849 Tenth Ave., New York 34, N. Y.

Please send me the units checked. I am enclosing the down payment with order and agree to pay the monthly balance as shown. It is understood there will be no carrying, interest or any other charges, provided I send my monthly payments when due. It is further understood that should I fail to make payment when due, the full unpaid balance shall become immediately due and payable.

Name

Address

City.....Zone.....State.....

- MODEL 670-A.....Total Price \$28.40 \$7.40 down payment. Balance \$3.50 monthly for 6 months.
- MODEL TV11.....Total Price \$47.50 \$11.50 down payment. Balance \$6.00 monthly for 6 months.
- MODEL 660-A.....Total Price \$42.95 \$12.95 down payment. Balance \$5.00 monthly for 6 months.
- I enclose \$.....as down payment.
- Ship C.O.D. for the down payment.

**NO
INTEREST!!**

Buy on our radically new
Time Payment Plan

**NO CARRYING
CHARGES!!**

Superior's New Model 770-A The FIRST Pocket-Sized



VOLT-OHM MILLIAMMETER USING THE NEW "FULL-VIEW" METER

**71% MORE SCALE
AREA!!**

Yes, although our new FULL-VIEW D'Arsonval type meter occupies exactly the same space used by the older standard 2 1/2" Meters, it provides 71% more scale area. As a result, all calibrations are printed in large easy-to-read type and for the first time it is now possible to obtain measurements instead of approximations on a popular priced pocket-sized V.O.M.

Features

- ★ Compact — measures 3 1/8" x 5 7/8" x 2 1/4"
- ★ Uses "Full View" 2% accurate, 850 Microampere D'Arsonval type meter
- ★ Housed in round-cornered, molded case
- ★ Beautiful black etched panel. Depressed letters filled with permanent white, insures long-life even with constant use.

Specifications

6 A.C. VOLTAGE RANGES: 0-15/30/-150/300/1500/3000 Volts. 6 D.C. VOLTAGE RANGES: 0-7.5/15/75/150/-750/1500 Volts. 2 RESISTANCE RANGES: 0-10,000 Ohms, 0.1 Megohm. 3 D.C. CURRENT RANGES: 0-15/150 Ma., 0-1.5 Amps. 3 DECIBEL RANGES: -6 db to +18 db, +14 db to +38 db, +34 db to +58 db.

\$15⁸⁵
NET

THE MODEL 770-A COMES COMPLETE WITH SELF-CONTAINED BATTERIES, TEST LEADS AND ALL OPERATING INSTRUCTIONS. ONLY

Superior's New Model 70 UTILITY TESTER

FOR REPAIRING ALL ELECTRICAL APPLIANCES • MOTORS • AUTOS

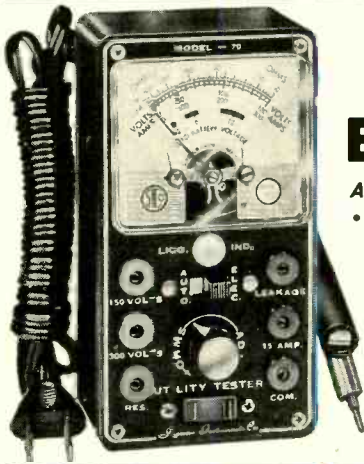

As an electrical trouble shooter the Model 70:

- Measures A.C. and D.C. Voltages, A.C. and D.C. Current, Resistances, Leakage, etc.
- Will measure current consumption while the appliance under test is in operation.
- Incorporates a sensitive direct-reading resistance range which will measure all resistances commonly used in electrical appliances, motors, etc.
- Leakage detecting circuit will indicate continuity from zero ohms to 5 megohms (5,000,000 ohms).
- Will test Toasters, Irons, Broilers, Heating Pads, Clocks, Fans, Vacuum Cleaners, Refrigerators, Lamps, Fluorescents, Switches, Thermostats, etc.

As an Automotive Tester the Model 70 will test:

- Both 6 Volt and 12 Volt Storage Batteries • Generators • Starters • Distributors • Ignition Coils • Regulators • Relays • Circuit Breakers • Cigarette Lighters • Stop Lights • Condensers • Directional Signal Systems • All Lamps and Bulbs • Fuses • Heating Systems • Horns • Also will locate poor grounds, breaks in wiring, poor connections, etc.

Handsome round-cornered molded bakelite case, 3 1/8" x 5 7/8" x 2 1/4". Complete with all test leads. Also included is a 64 page book giving detailed instructions for testing all electrical appliances, automotive only

\$15⁸⁵
NET

SUPERIOR'S NEW MODEL TV-40

C.R.T. TUBE TESTER

A complete picture tube tester
★ for little more than the price
of a "make-shift" adapter!!

Tests all magnetically deflected
★ tubes . . . in the set . . . out
of the set . . . in the carton!!



The Model TV-40 is absolutely complete! Self-contained, including built-in power supply. It tests picture tubes in the only practical way to efficiently test such tubes; that is by the use of a separate instrument which is designed exclusively to test the ever increasing number of picture tubes!

EASY TO USE:

Simply insert line cord into any 110 volt A.C. outlet, then attach tester socket to tube base (ION TRAP NEED NOT BE ON TUBE). Throw switch up for quality test . . . read direct on Good-Bad scale. Throw switch down for all leakage tests.

SPECIFICATIONS:

- Tests ALL magnetically deflected picture tubes from 7 inch to 30 inch types.
- Tests for quality by the well established emission method. All readings on "Good-Bad" scale.
- Tests for inter-element shorts and leakages up to 5 megohms.
- Test for open elements.

Model TV-40 C.R.T. Tube Tester comes absolutely complete—nothing else to buy. Housed in round cornered, molded bakelite case. Only

\$15⁸⁵
NET

MOSS ELECTRONIC DISTRIBUTING CO., INC.
Dept. B-105, 3849 Tenth Ave., New York 34, N. Y.

Please send me the units checked. I am enclosing the down payment with order and agree to pay the monthly balance as shown. It is understood there will be no carrying, interest or any other charges, provided I send my monthly payments when due. It is further understood that should I fail to make payment when due, the full unpaid balance shall become immediately due and payable.

Name

Address

City.....Zone.....State.....

- | | | |
|--------------------------|-----------------------|-----------------------|
| <input type="checkbox"/> | Model 770-A..... | Total Price \$15.85 |
| | \$3.85 down payment. | Balance \$4.00 |
| | monthly for 3 months. | |
| <input type="checkbox"/> | Model 70..... | Total Price \$15.85 |
| | \$3.85 down payment. | Balance \$4.00 |
| | monthly for 3 months. | |
| <input type="checkbox"/> | Model TV-40..... | Total Price \$15.85 |
| | \$3.85 down payment. | Balance \$4.00 |
| | monthly for 3 months. | |
| <input type="checkbox"/> | I enclose \$..... | as down payment. |
| <input type="checkbox"/> | SHIP C.O.D. | for the down payment. |

other end of this capacitor goes to a binding post added to the panel. The hot lead from the vertical input of the scope now goes to this post. The horizontal amplifier is in the internal sweep position.

The IM analyzer feeds the amplifier under test as usual; and the output of the amplifier goes to the analyzer input. The vertical channel of the scope goes to the new binding post and ground of the analyzer. The sweep is adjusted for 60 cycles (or if your analyzer has another low frequency, for that frequency). This will produce a pattern such as indicated at Fig. 1-a. If there is no IM, the top and bottom of the trace will be flat. But, if there is any IM, the high frequency will be modulated by the low frequency and both the top and bottom will acquire some sort of curve or notches. The *depth* of the notches is proportional to the IM; the *number* of them is proportional to the aberrations causing the IM.*

The exact amount is not so important for servicing. What is significant is that the notches yield important clues to the causes of distortion. Most of the important ones are indicated in Fig. 1.

If the IM occurs in a single-ended stage, the pattern will have 2 or 4 notches, counting both those on top and bottom of the trace. Overdrive or underbias is indicated by sharp, rather narrow notches on one end; distortion due to curvature or overbias is indicated by wider, smoother notches on the other end. Which end the respective notches will occur on depends on the number of stages in the amplifier and the characteristics of the scope. In

most cases the overdrive notch will occur on the left. However, this is not too important, since the two types can be distinguished, if the scope trace is sharp and large enough, by the difference in the shape of the notch.

If the single-ended stage is so badly overdriven that the positive peak is clipped and the negative peak rounded by curvature, four notches will appear—two on top and two on the bottom. If these four appear simultaneously or in quick succession as the signal input is increased, the stage is operating very close to the center of its operating curve. When there is something wrong, however, one form will appear long before the other. If the sharp overdrive notches appear first, the trouble is underbias; if the more gentle curvature notches appear first, the trouble is overbias. Some sort of notches will appear with any amplifier, even one in perfect shape, at or near maximum output. It is when they occur below maximum output that trouble is indicated.

When the IM is produced in a push-pull stage, four notches are normal. If the stage is well balanced, the notches on top and bottom will appear simultaneously or in rapid succession as the input signal is increased. If the stage is unbalanced, the notches will appear first on one side and then the other; the degree of unbalance is indicated by the difference in depth between the notches on top and those on the bottom.

Here too, the notches on one end are due to overdrive and the notches on the other end are due to curvature. Because in well-balanced push-pull stages one half of the circuit will be driven into positive bias and the other half into cutoff at about the same point, four notches of equal depth, top

and bottom, indicate normal operation. So an examination of the trace, as the input signal is varied around the point at which the notches begin to show up, will indicate the trouble.

If the distorting push-pull stage is driven by a single-ended stage which is also overdriven, one of the notches will be reduced or completely eliminated. When this happens at a point much below maximum rated output, it is a good sign of trouble in the power supply, since such simultaneous overdrive is almost always produced by unduly low plate voltages.

Finally, parasitic oscillation or regeneration, especially motorboating at frequencies below 40 cycles, is evidenced by bumps and bulges instead of notches. Low-frequency parasitics will produce a rounding off of the whole pattern which will also grow vertically; high-frequency parasitics will put a lot of small bumps or spikes on the pattern.

You will note that most of the causes of distortion are indicated by these patterns. The significant thing is the point in the dynamic range of the equipment at which they appear. Therefore, a wattmeter makes this method extremely reliable. Thus, any amplifier can be overdriven; but this should not occur until near the maximum rated power output; if an overdrive notch occurs at half-rated-power output or less, it is clearly a definite indication of underbias.

This method is not as sensitive an indicator of distortion as the IM analyzer with the meter. Theoretically, if the trace were large enough, very low values of IM would be indicated. In practice, however, it is extremely difficult to synchronize a trace with low distortion if (as in most IM analyzers) the high frequency is more than 20 times that of the low frequency. Moreover, percentages of 2, 3, or 4 produce notch depths which are sometimes no deeper than the thickness of the scope trace; hence, unless very high accelerating potentials are used in the scope, the low percentages are obscured.

This is not critical for servicing; for the signal input to the amplifier can usually be increased until the distortion is visible. The fine thing about this method is, first, that it does give definite clues as to the cause of the trouble, and, second, that the IM is indicated dynamically, and it can be observed to change as signal input is varied, or as circuit adjustments are made. If this procedure is used with the same sequence setup described earlier for the IM analyzer alone, diagnosis will be much more rapid.

It will take some experience to get onto it. Excellent training can be obtained by equipping a simple amplifier with variable resistors in the cathode and plate circuits. As these are varied, the variations in notches which follow overbiasing, underbiasing, too low a plate load, unbalance, etc., can be observed, and the effect of making corrections noted. (TO BE CONTINUED)

*Le Bel, "New Method of Measuring and Analyzing Intermodulation." *Audio Engineering*, July, 1951.

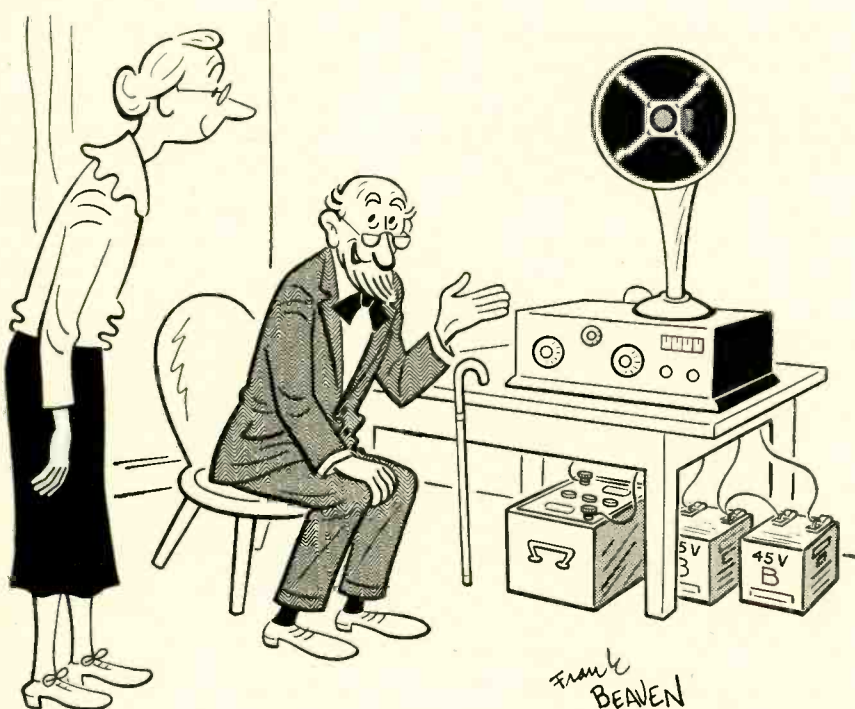

"Yes-sir-eee! The set sounds better than ever since we changed over to Hi-Fi!"

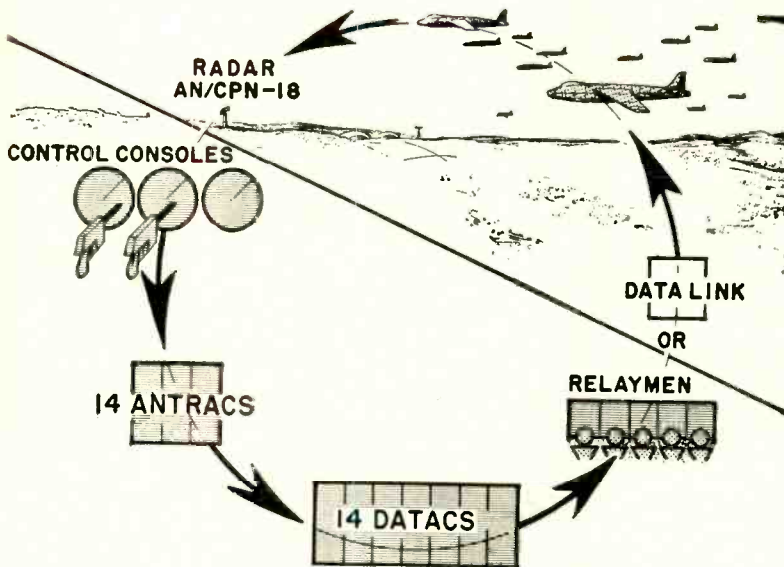

Progress of information through the Volscan system.

WHEN a large number of military aircraft return to a base within a short time, a terrific air traffic control problem is set up. The problem becomes greater when we consider that more and more jets are being used. They have to be landed as quickly as possible because the lower they fly, the more fuel they use. Therefore, if the landing operation takes too long, the jets can very easily give out of fuel and crash. No human being can control more than 40 planes an hour. The problem was how to land 120 planes or more an hour. It was solved with the Volscan Air Traffic Control System, developed under Ben F. Green, Air Force Cambridge Research Center.

Volscan—closed-loop system

To control 120 aircraft an hour Volscan uses two identical Traffic

Operator Consoles and one Monitor Console. The Traffic Operators use a common radio channel to answer incoming aircraft. Each console has a PPI scope, a panel controlling seven Antrac-Datrac channels, and a Volscan Light Gun for assigning Antracs (Automatic tracking-while-scanning).

The Monitor's PPI permits him to watch the progress of all controlled aircraft. His time-situation panel shows the type and scheduled arrival time of each aircraft. Push-buttons permit him to change their automatically assigned schedules or to reserve time in the future for take-offs. The controls for setting in the wind direction and velocity and entry gate locations are also on his panel.

Antrac

An Antrac is assigned to the radar target by pointing the Volscan Light

Gun at the corresponding blip on the PPI. When the light gun is pointed at a signal on the PPI, the light from that signal alone enters the barrel, thus effecting a time coincidence which moves the tracking gate to the position on the scope at which the gun is pointed. Once the Antrac is assigned, it isolates the target from all others by throwing a "gate" around it. Since this gate moves, following the blip, the Antrac retains the identity of the target.

An Antrac sorts out the data on a specific aircraft by generating two electronic time gates, one representing the predicted range of the aircraft plus and minus the gate width, and the other having the same function for azimuth. Since it is required that an incoming radar echo coincide with both these gates to enter an Antrac, each Antrac receives video signals from only aircraft that are within the area of space defined by the coincided range-azimuth gates. When a new echo from the aircraft does enter the Antrac, the error between the gate position and the echo is measured electronically and is utilized to correct the gate's position and velocity, which are then stored for use until the next echo is received.

As the Antrac, in a period of several scans, acquires the velocity of the target, it smoothes the periodic video pulses that are the input into a gradually changing d.c. output. By holding the target velocity in its memory, the Antrac predicts where the target is during radar fades by continuing to move at the last rate it had memorized. The young lady on the cover has placed four gates on the PPI scope. The Antrac continuously reports to the computer the exact positions of the four targets.

Datrac

A channel of the Volscan computer called Datrac, automatically selects a scheduled arrival time for the aircraft and calculates heading and altitude orders which will make good this schedule.

Datrac calculates the aircraft's direct

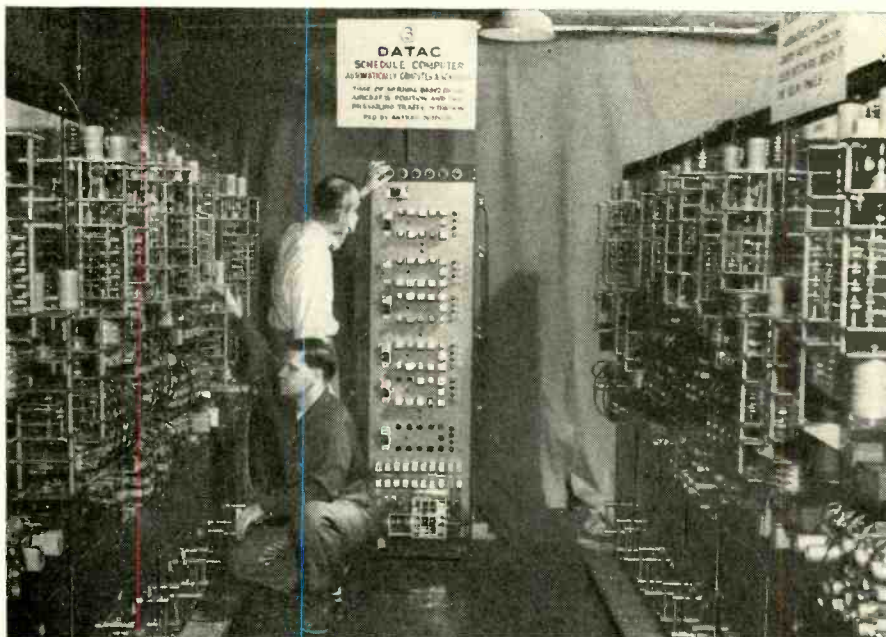

Rear-panel view of the equipment used in the Volscan system at Fort Dawes, Mass.

BUY DIRECT . . . and SAVE!

'PRE-FAB' **COLLINS** TUNERS
AUDIO PRODUCTS CO.

High Fidelity TUNERS and TUNER KITS
introducing the LATEST DESIGN

COLLINS CHROMATIC TUNER

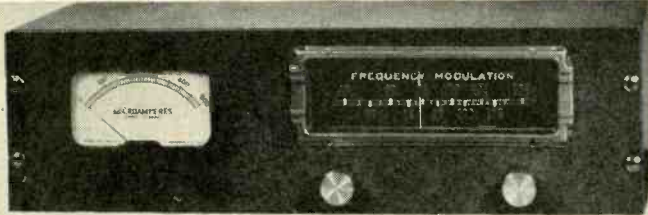

CHECK THESE OUTSTANDING FEATURES

- 4 1/2" tuning meter. Each tuner calibrated in microvolts for direct reading of signal strength.
- Not a kit. Completely wired, ready to use with FM antenna and amplifier.
- Sensitivity 3 microvolts with 20 DB of quieting.
- A.F.C. with disabling switch.
- New, compact, low design. Only 5 1/4" high. Matches latest bookshelf amplifiers.
- Voltage regulator tube for added stability.
- Newly designed front-end using 6BQ7 tube.
- Dual simultaneous audio output—high and low impedance.
- Ultra wide range response, 20 to 25,000 cycles.
- Distortion less than 3/4 of 1%. Hum 50 DB below program.
- Beautiful golden brown metal cabinet completely enclosing tuner.
- 3 1/4" x 19" relay rack panel integral part of cabinet.
- Twelve tubes.
- Tone compensated volume control.

Plus many other smaller features which make this tuner the hottest item since high fidelity

Overall size: 19" W. x 5 1/4" H. x 8 1/2" D.
Shipping weight: 15 lbs.

\$97⁵⁰

COLLINS PRE-FAB KITS ALSO AVAILABLE

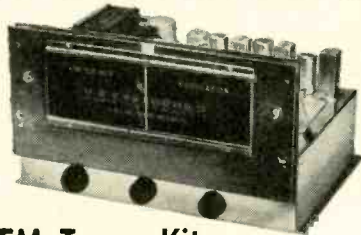

FM Tuner Kit

Shipping weight: 14 lbs. **\$55** with AFC **\$58.50**



FM/AM Tuner Kit

Shipping Weight 19 lbs. **\$77⁵⁰** with AFC **\$81**

IF-6 Amplifier . . .

6 tubes
Shipping Weight 3 lbs. **\$19⁷⁵**

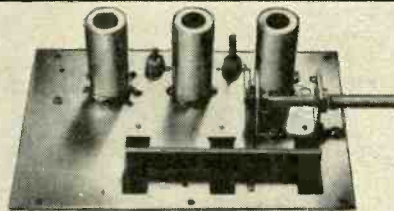

FMF-3 Tuning Unit

Shipping weight: 2 1/2 lbs. **\$15²⁵** with AFC **\$18.75**



AM-4 Tuning Unit

\$24⁵⁰ Shipping weight: 2 1/2 lbs.

For Users of Collins Tuners:

Receive \$5.00 credit toward the new FMF-3A front end! Mail us your old front end with \$13.75 and we will send you the new, improved FMF-3A with AFC or, remit the full amount of \$18.75 and when we receive your old unit in return a check will be mailed you for \$5.00.

Collins Audio Products Co. is in no way affiliated with Collins Radio Co.

To: Collins Audio Products Co. Inc.
P.O. Box 368, Westfield, N. J. Dept. RE7
Tel. WEStfield 2-4390

- | | | |
|---|--|--|
| <input type="checkbox"/> Chromatic Tuner | <input type="checkbox"/> FM Tuner Kit | <input type="checkbox"/> FM/AM Tuner Kit |
| <input type="checkbox"/> IF-6 Amplifier | <input type="checkbox"/> with AFC | <input type="checkbox"/> with AFC |
| <input type="checkbox"/> AM-4 Tuning Unit | <input type="checkbox"/> FMF-3 Tun. Unit | <input type="checkbox"/> with AFC |

Name _____
Address _____
City _____ State _____
Amount for Kit \$ _____ See weights, add shipping cost \$ _____
Total amount enclosed \$ _____ Check Money Order

Mail Coupon Today

flight time over the shortest possible path, which is the tangent path to the final turn circle. It reserves the earliest possible scheduled arrival time which the aircraft can make without conflict with other inbound traffic.

Throughout the run, Datac computes an error ratio which indicates the aircraft's performance in relation to its schedule. If the aircraft is on time, Datac orders a heading which directs it along the tangent path at present velocity. If the aircraft is late, Datac orders a heading which will hold it on the tangent path and increase velocity. If the aircraft is early, Datac orders an offset heading proportional to the magnitude of the error ratio so that the aircraft will be delayed sufficiently to meet its schedule.

Datac does not predict a fixed path for the aircraft, but is always calculating to see what heading it should fly to make good its schedule. It controls the descent of the aircraft so that it will reach the entry gate at correct altitude.

The Datac control orders are relayed to the aircraft by voice or are sent automatically over the Data Link for display on the Zero Reader or for injection into the aircraft's autopilot.

As the plane responds to the control orders, the radar reports the change in its position, thus completing the loop.

The tracking and computing equipment making up the Volscan can be utilized in building-block fashion to meet the needs of any particular installation. For instance, if the traffic rate at a base increases, one additional console and seven additional channels can be added.

One Volscan channel contains only 60 tubes. Since a Volscan airbase installation consists principally of a number of such channels, it is not necessary to provide spares; each is a spare for the others.

Volscan can deliver aircraft satisfactorily to terminal points as far away as 20 miles, with some reduction in traffic rate, and as close as 2 miles, with no reduction in rate. END

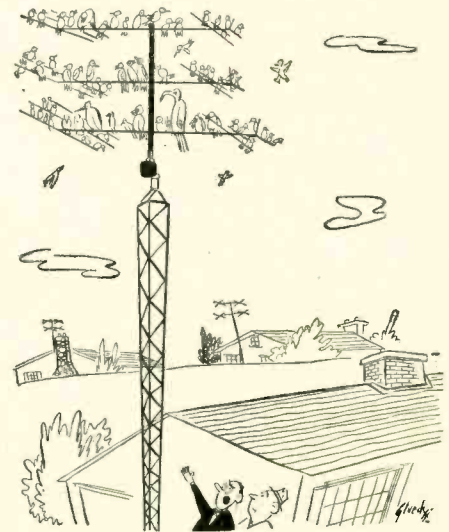

"Spend a fortune for an antenna and I get birds!"

transistors

from N to P

First of an
intermittent series
in a field
where information
is welcome

By GEORGE FLETCHER COOPER

DOROTHY PARKER once said of a "friend" that she covered the whole gamut of emotions from A to B. This article is the first of a series—maybe regular, maybe not—which will try to provide some sort of background to those other articles on a transistorized television set, a semiconductor moon rocket, and other devices, which are bound to appear in ever-increasing numbers. I shall not start at the beginning, because the beginning is too difficult and too remote; I shall not go on to the end, because no one man in one lifetime could attempt such a task; and I shall not try to be consecutive, because each article must be about something, and not merely a preparation for a beginning to an introduction. All I want to do in these articles is to make you feel that you know enough about transistors to build something yourself.

Transistors, as you can't help knowing, are . . . well, what are they? Semiconducting amplifying . . . no, the current-amplification factor of a junction transistor is less than unity. Perhaps I should search through the books to see what other people have said, but when I do I run slap into:

"Transistor electronics exists because of the controlled presence of imperfections in otherwise nearly perfect crystals."¹

That isn't the sort of thing we can use at all. Let us just say that a transistor is a semiconductor device with at least three terminals, and that it will do the same kind of job as a vacuum tube.

Whatever the definition, there are two main kinds of transistors, the point type and the junction type. Roughly (and it is because this is really only very roughly correct that we need these articles) they behave like the triode and the pentode, respectively. The junction type may be what is called an n-p-n transistor or it may be a p-n-p transistor. There is nothing in the vacuum-tube field which corresponds

to this difference, which is one of polarity. We ground the negative terminal of our battery in n-p-n circuits, but ground the positive terminal in p-n-p circuits. You see the difference is not altogether unimportant. The rather awkward names, n-p-n and p-n-p, refer to the constituents of the "sandwich," which looks something like Fig. 1: n-type and p-type refer to the germanium, which, is as pure as possible, but doped to have about 1 part in 100 million of "controlled" impurity. The sort of impurity settles whether it is n- or p-type. In the point transistor, n-type germanium is used. Down inside the material the system is actually p-n-p, as you can see from Fig. 2: under the emitter and collector points the material has been converted to p-type.

For memory, the point transistor is a p-n-p: A ham sandwich has ham in the middle. An n-p-n transistor uses a positive main supply; a p-n-p transistor uses a negative main supply.

In the point transistor we put a fairly large negative voltage on the collector, and ground the base. The collector junction (in Fig. 2) is biased in the nonconducting direction, but there will be a small current, perhaps 0.5 ma at 20 volts. This is just the ordinary current through the back resistance of a diode. In Fig. 2 the electrons which leak through the junction are shown as solid dots moving toward the base in line ahead. Now we connect a battery with its positive pole at the emitter and its negative to base. The diode on the left conducts easily, of course, and only about 0.5 volt is needed to pass 1 ma into the emitter circuit. The effect of this emitter current, however, is not just a flow of electrons from base to emitter. Holes are also injected into the n-type material at the emitter junction, and these drift over to the collector junction, because they are attracted by the field of the collector voltage. These holes are very important, because the transistor action depends on them. What are they?

Suppose you consider your bank

account and your wife's. Your wife—like most engineer's wives—has no money; you are overdrawn by \$150, like most engineers. She, a thoroughly good-hearted woman, draws a check for \$150 and gives it to you to pay into your account. This delicate financial operation transfers your overdraft to her.

Holes are just overdrafts, but of electrons, not dollars. And when those holes drift over to where the electrons are plentiful, near the collector junction, they behave just like the mortgage in the old-time melodrama, and there is plenty of action. The arrival of a hole at the collector barrier (in a point-contact transistor) allows several electrons to slip through.

Notice this very carefully: You put in a hole current at E, and you get a change in electron current at C. With a tube the corresponding experiment is to apply a bias voltage to the grid and

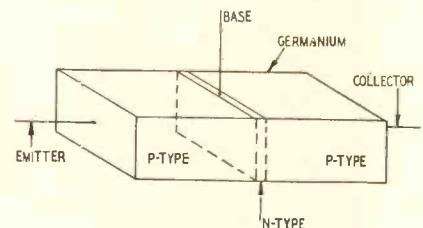

Fig. 1—A p-n-p junction transistor.

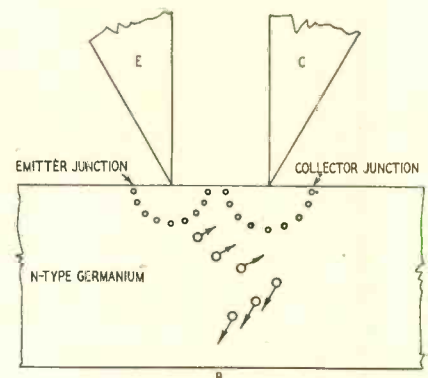
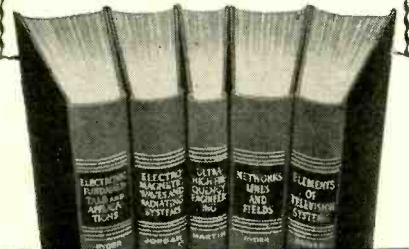

Fig. 2—The point-contact p-n-p type.

¹Shockley, Proc. I.R.E. Nov. 1952, p. 1289.

Examine FREE



**Prentice-Hall
ELECTRONICS &
UHF LIBRARY**

Edited by W. L. EVERITT

5 VOLUMES 1662 ILLUSTRATIONS

Pay Easy Installments If You Keep Set

Turn to this new, up-to-date Library with complete confidence, for dependable facts on any phase of modern electronic theory and practice. These volumes, by outstanding authorities, give you thorough guidance—clearly written, logically arranged, profusely illustrated.

Electronic Fundamentals and Applications

By Prof. John D. Ryder, Univ. of Illinois

Complete, logical, easy-to-follow treatment of (a) physical principles underlying electron tubes, (b) characteristics of vacuum tubes, (c) all basic tube circuits. Includes: Electron Ballistics, Cathode-Ray Tubes, Emission of Electrons, Space Charge in Vacuum Tubes, Diode Rectifiers, Triodes, Multi-Element Tubes, Small-Signal Amplifier Circuits, Audio-Frequency Amplifiers, Radio-Frequency Amplifiers, Oscillator Circuits, Modulation Systems, Wave-Shaping Circuits, Gaseous Conduction, Gas Diodes, Gas Control Tubes and Circuits, Photoelectric Cells, Solid-State Electronics.

Electromagnetic Waves and Radiating Systems

By Prof. Edward C. Jordan, Univ. of Illinois

Covers entire field of electromagnetic engineering. Includes propagation as well as radiation and transmission. Full treatment of UHF transmission lines, wave guides, antennas, slot antennas, radiation and diffraction, ground-wave and sky-wave propagation.

Ultra High Frequency Engineering

By Thomas L. Martin, Univ. of Arizona

Theory and technique of ALL the new fields of electronic engineering: Radar, Telemetering, Electronic computing, Facsimile, Television, Blind landing systems, Pulse-time modulation, Ionosphere measurements . . . and the others.

Networks, Lines and Fields

By Prof. John D. Ryder, Univ. of Illinois

Network transformation and theorems. Resonance. Impedance transformation and coupled circuits. Filters. General transmission line. High-frequency line. Equations of the electromagnetic field. Radiation. Transmission and reflection of plane waves at boundaries. Guided waves between parallel planes. Wave guides.

Elements of Television Systems

By George E. Anner, University of Illinois

Complete basic theory, plus current practice, covering: Closed TV Systems, Commercial Telecasting Systems, Color TV Systems. Gives clear exposition of all phases of picture transmission, including the new technique of dot interlace.

SEND NO MONEY — EXAMINE FREE

Just mail coupon below to get complete 5-Volume Set on 10 DAYS' FREE TRIAL. If not completely satisfactory, return in ten days and owe nothing. Or keep the set and pay only \$5.35 down and \$8 a month for five months until full price of \$45.35 is paid. Decide for yourself—without risk or obligation—just mail coupon to examine Library ten days free.

PRENTICE-HALL, Inc., Dept. M-RE-754
Englewood Cliffs, New Jersey

Send me the Prentice-Hall ELECTRONICS & UHF LIBRARY (5 Volumes) for ten days' free examination. If fully satisfied in ten days I will send you \$5.35 plus few cents postage and then \$8 a month for five months until full price of \$45.35 is paid. Or I will return the Library in ten days and owe nothing.

Name
Address
City and State

see how the plate voltage changes. The ratio of plate voltage change (at constant current) to grid voltage change is the amplification factor: in a transistor test the ratio of collector-current change (at constant voltage) to emitter current is called the current gain, and is written as α (alpha). For a point transistor, alpha may very easily be around 2.

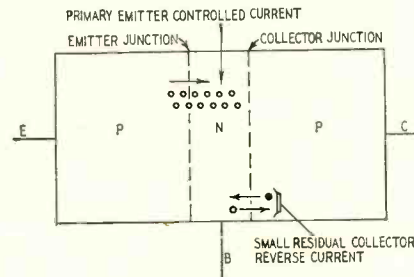

Fig. 3—Inside a junction transistor. The p-n-p unit is shown schematically.

Since the emitter circuit is of low impedance, we must take our input signal from a low-impedance source, but we then put a high impedance in the collector circuit. We might, for example, use 500 ohms for the emitter circuit and 10,000 ohms for the collector. A change of 1 ma in 500 ohms corresponds to 0.5 volt, and the amplified change, 2 ma in 10,000 ohms, gives us 20 volts, so that the voltage gain would be 40 times. The power gain, which is the thing that really matters, is 80 times, or 19 db.

When working with point transistors it is always advisable to think in terms of current, especially at the input side. If you find the idea of amplification factor in your mind, be sure it's the *current* gain, alpha. When the tubeminded engineer thinks of transconductance, the transistor-minded engineer thinks of *transimpedance*, in volts/milliamperes, for which a typical value might be 90.

Point transistors have some rather unpleasant characteristics. The circuits easily become unstable, and unless you take special precautions the result may be to destroy the transistor completely. You can do the same sort of thing with a tube, of course, but we know now that you must not disconnect the load on an output tetrode, or put positive bias on the grid, or do any of a number of other silly things. When you get used to transistors you know what you must avoid, and it just doesn't worry you any more. But it is easier to start off with the junction transistors, especially now that you can buy them: at one time, of course, when they were not readily available we just had to accept the prob-

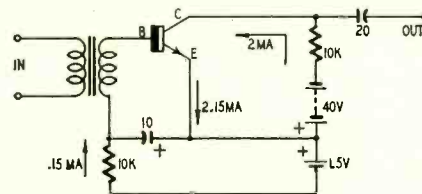

Fig. 4—Practical transistor hookup.

lems of the point type. This is no longer necessary.

The junction transistor is shown schematically in Fig. 3. This is a p-n-p transistor, with negative on the collector. A small flow of current across the back resistance of the collector junction, perhaps 0.05 ma for 40 volts, is produced if the emitter is not connected. The n-p junction provides, as you can see, a very good rectifier action. Now we apply a small positive bias to the emitter. "Holes" rush in from the emitter to the central region, wander across to the collector junction and find it easy to cross the barrier to the collector. Nearly every hole which leaves the emitter comes through to the collector; only a few get lost and provide a current in the base lead.

The current gain of a junction transistor is less than 1, and, depending on the type, may be 0.90, 0.95, or 0.99. All the amplification depends on the fact that you put in a signal at a low impedance and take it out at a high impedance, just as you do in the grounded grid triode amplifier.

For the beginner this approach to the junction transistor may still cause a little confusion, and there is quite a lot to be said for starting off with the grounded-emitter circuit. The simplest form of amplifier is shown in Fig. 4, which is for a transistor having an alpha of 0.93. The collector current of 2 ma and emitter current of 2.15 ma mean that the current in the base must be 0.15 ma, and this bias comes from the 1.5-volt battery and 10,000-ohm resistor on the left. Any change in base current will alter the conditions. Now

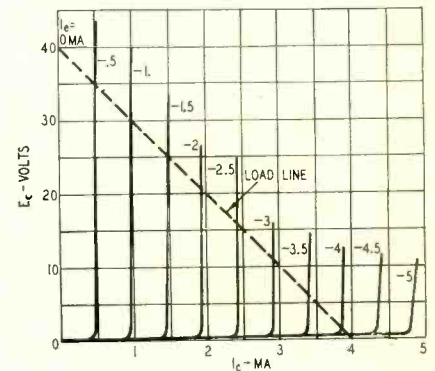

Fig. 5—Characteristics of the Western Electric M1752 junction transistor.

in the simplest possible way of looking at things:

$$I_c = I_e - I_b$$

$$= \alpha I_e - I_b$$

$$\text{so } I_c = \frac{I_b}{1 - \alpha}$$

If we feed in a signal of i_b milliamperes through the transformer, the collector current will carry a signal component of $\frac{1}{1 - \alpha} \cdot i_b$ ma. In our typical case, we have

$$\frac{1}{1 - \alpha} = \frac{1}{1 - 0.93} = \frac{1}{0.07} = 14$$

so that the current gain of this arrangement is 14 times.

INTERNATIONAL RECTIFIER

C O R P O R A T I O N



EL SEGUNDO
CALIFORNIA

*Selenium
Rectifiers*

for
direct **TV-RADIO**
replacement

WIDEST RANGE IN THE INDUSTRY

The type you need...
when you need it!

AVAILABLE FROM YOUR FAVORITE JOBBER

Available
with
universal
mounting
for
universal
replacement.

For more
information
write Dept. A
for Bulletin JRP-2

INTERNATIONAL RECTIFIER

C O R P O R A T I O N

Executive Offices: 1521 E. Grand Ave., El Segundo, Calif. · Phone: ORegon 8-6281
Chicago Branch Office: 205 West Wacker Drive · Phone: Franklin 2-3889
New York Branch Office: 501 Madison Avenue · Phone: Plaza 5-8665

Ready NOW!

completely NEW STANCOR TV TRANSFORMER REPLACEMENT GUIDE

The new 1954 Stancor TV Replacement Guide and Catalog is a fully revised, up-to-the-minute listing of accurate transformer replacement data. Every recommendation has been rechecked against the latest information obtainable.

This Stancor reference lists over 6800 TV models and chassis of 115 manufacturers, including hard-to-locate information on "private label" sets.

To make your servicing easier, virtually all flybacks, yokes and power transformers listed are exact replacements. Where an exact replacement unit is not available, reference is made to the circuit or terminal changes required.



Stancor transformers are listed in Photofact Folders and Counterfacts.

CHICAGO STANDARD TRANSFORMER CORPORATION
3592 Elston Avenue Chicago 18, Illinois

EXPORT SALES: Roburn Agencies, Inc., 39 Warren Street, New York 7, N. Y.

TRAIN AT HOME FOR COLOR-TV and

TELEVISION SERVICING

Learn practical, professional type TV Servicing without leaving your present job. Included are money-making extras, such as set conversion, master antenna installation, UHF-TV, NTSC Color System, field servicing short cuts. You can start earning Television money after first few lessons. You learn to test, trouble shoot and repair all types of TV sets.

HERE'S HOW YOU GET EXPERIENCE!

You train on a large screen, modern TV receiver, furnished with the course and yours to keep! As an optional feature you can get two weeks actual experience with Chicago's largest independent servicing organization. You learn by doing! Age is no barrier. Many students are over 40! Beginner's Course available. Send for FREE Catalog and SAMPLE LESSON today!

TV COMMUNICATIONS INST.

605 W. Washington Blvd.
Dept. RE-31, Chicago 6, Ill.

VETERANS!
T.C.I. is approved for G.I. training. Under Public Law 550. Check coupon.

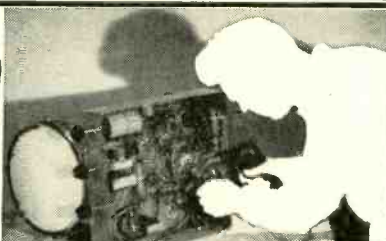

MAIL NOW FOR FREE BOOKLET!

MILTON S. KIVER, President
TELEVISION COMMUNICATIONS INST.
605 W. Washington Blvd., Dept. RE-31, Chicago 6, Ill.

Rush FREE Catalog and Sample Lesson. I am not obligated. Salesman will not call.

Name Veterans: Check here

Address

City Zone State

BEGINNERS check here for Basic TV Course.



FREE

If you haven't received your copy, see your Stancor distributor, or write us directly.

STANCOR-WILLIAMSON ULTRA-LINEAR HI-FI amplifier bulletin 479

Build your own ultra-linear hi-fi amplifier using Stancor high fidelity output transformer A-8072 (\$15.00 net). You can also use A-8072 to convert your present Williamson amplifier to ultra-linear operation. Bulletin 479, available FREE, contains performance curves, schematics, parts lists, chassis layouts and other helpful construction and conversion information.

You can't do better than start with this circuit, at audio, if you want to get used to transistors. But why 10,000 ohms in the collector circuit? What turns ratio does the transformer have? Take a look at Fig. 5, which shows the characteristics of the Western Electric M1752 junction transistor. The load

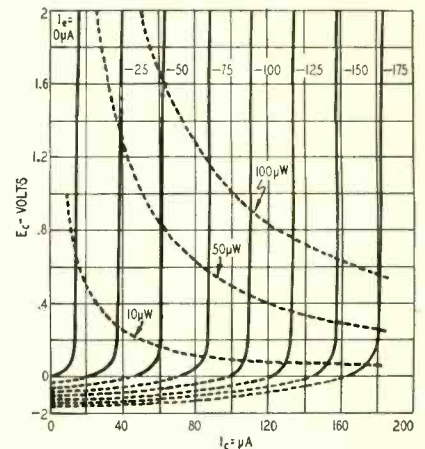

Fig. 6—The M1752's low-level response.

line shown allows a dissipation of 40 mw at the working point, 20 volts and 2 ma. You can draw in a safe load line on the corresponding characteristics of the transistor you use, just the same as you would do for a conventional vacuum tube.

To find the transformer ratio you need more of the transistor data. You will find the maker gives you two numbers: r_b the base resistance, and r_e the emitter resistance.

Roughly—we shall go into more detail later, perhaps—the input resistance is

$$\frac{r_b + r_e}{1 - \alpha}$$

From this, you can easily calculate the input resistance. For the M1752, Morton gives: $r_e = 25$; $r_b = 250$; and $\alpha = 0.95$ so that the input resistance is $250 + 25 / (1 - 0.95) = 250 + 25 / 0.05 = 750$ ohms. The value of α could be 0.99, in which case the input resistance would 2,750 ohms, with the two r's left

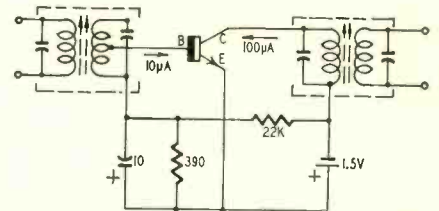

Fig. 7—Circuit for the experimenter.

unaltered. That should tell you the sort of input impedance that might possibly be expected.

The amplifier shown is designed for the maximum working level that the transistor will stand. It is not very high, and there is not much you can do with it. But there are many places where much lower levels are used—in ordinary broadcast receivers, for example. The characteristics shown in Fig. 6 show that the junction transistor will work well down to very low levels, with

corresponding economy in battery current. Fig. 7 shows how an r.f. or i.f. stage might be built, though the exact values of bias resistance will depend on the transistor you use. With an n-p-n transistor, just reverse the polarity of the battery.

The conscientious student who looks closely at Fig. 7 will already have noticed that although the battery pushes 100 μ a into the transistor, it

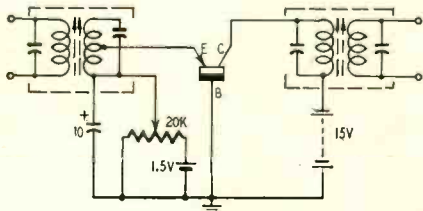

Fig. 8—A separate bias can be used.

also pushes 75 μ a through the bias network. In a way, this is the price you must pay for using a single transistor, but the extravagant use of power—75 μ a wasted!—is necessary to make the circuit behave well.

One advantage of starting off with the circuit shown in Fig. 7 is that you can't do much damage anywhere in this circuit. All you need is a few ordinary i.f. transformers, with an extra tap, well down, to give you the right base connection—suppose you tap down at about one-tenth of the secondary turns; connect up one or more stages in tandem and then connect this i.f. amplifier between the first mixer and the detector in that old broadcast receiver. And there you have a transistor system working!

What if you want to use point transistors, though? The base input, grounded-emitter circuit is very tricky then, because, for reasons which I must pass for the moment, any impedance in the base tends to make this arrange-

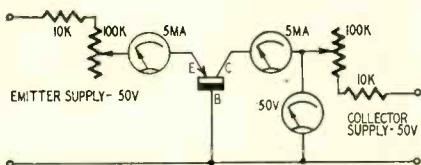

Fig. 9—"Tube tester" for transistors.

ment unstable. The input impedance will be rather lower, so that the tap must be moved down. More serious, however, is that fact that you will need to use a battery in the 10-20 volt region instead of the 1.5 volts we have just discussed, and you must draw perhaps 4 ma in the collector circuit and 1-2 ma in the emitter circuit. The use of a separate bias battery, is then worth while, and the circuit comes to look like Fig. 8. It is still cheaper to run than a tube amplifier, of course, but it is much more extravagant than the junction transistor circuit.

If you decide that you do want to try transistors, and that you want to do it my way, you will stick to these simple circuits. But having got hold of a transistor or two, how can you find out if they are any good or not? I myself have a nice machine that photographs

the set of characteristics so that I need not do anything except connect the transistor in the circuit, switch on, press the camera button, and then enlarge the photograph. It took quite a time to build. A simple arrangement which is quite useful is shown in Fig. 9. The fixed 10,000-ohm resistors are provided to limit the current to 5 ma, which is safe for most transistors. In using the tester you set the emitter current to, say, 1 ma, and then vary the collector current with the series resistor, plotting voltage as a function of current. The high-voltage, high-resistance emitter feed circuit is very useful because it makes the emitter current independent of the collector current. This saves a great deal of time and trouble. This test set is particularly suitable for use with point transistors. Junction transistors are better tested, I think, by using the grounded-emitter connection, in which case the base supply, on the left, need be only a 10-volt battery, and the variable resistor should have a range up to 1 megohm. The advantage of the grounded-emitter presentation is that the knee of the curve is less sharp, the slope of the nearly constant collector current region less flat, so that the deviations from the ideal are rather more easily seen. And also, of course, that is the way we like to use the junction transistor.

Just how much you need to know about what happens inside a transistor to be able to use one is anybody's guess. To date there are two main approaches: the network theory, and the electron-physics approach. I have used a little of each to show the fundamental concepts for properly understanding transistors.

This article is meant to be only a beginning, a first step on the road of exploration of what we already can do with transistors. I do not aim to tell you how to build a television set using transistors only, nor do I intend to show you neat little boxes which you can copy. But I hope that these articles can help you to design your own circuits, and to understand other people's. END



"I think I just broke Ohm's Law."



Special Offer On This Complete RADIO ENGINEERING LIBRARY

The Famous Library that Brings High-powered Help on the Whole Field of Radio Engineering. Places Authoritative Facts, Standards, Data, Practice, and Theory At Your Fingertips.

Now offered at a special low price, the Radio Engineering Library brings you almost 4000 pages of tested methods, standards, data and accepted practice. This Library will help solve hundreds of problems for designers, researchers, engineers, and students in any field based on radio.

Written by leading radio engineers, these books cover circuit phenomena, networks, tube theory, vacuum tubes, amplification, measurements, etc.—give specialized treatment of all fields of practical design and application. They provide you with a complete and dependable encyclopedia of facts.

5 volumes, 3872 pages, 2770 illustrations

- Eastman's FUNDAMENTALS OF VACUUM TUBES, 3rd Edition
- Terman's RADIO ENGINEERING, 3rd Edition
- Everitt's COMMUNICATION ENGINEERING, 2nd Edition
- Hund's HIGH FREQUENCY MEASUREMENTS, 2nd Edition
- Henny's RADIO ENGINEERING HANDBOOK, 4th Edition

SEND NO MONEY

Special Low Price—Easy Terms

On this special offer you get this Library for \$38, instead of \$48. You save \$10 and may pay on easy terms. Mail coupon below to examine the Library FREE for 10 days. No obligation. These books are recognized as standard works; you are bound to need them. So take advantage of this special money-saving offer. Mail coupon at once!

McGraw-Hill Book Co., Dept. RE-7
327 West 41st St., New York 36, N. Y.

Send for 10 days' FREE trial, the RADIO ENGINEERING LIBRARY. If not satisfied I will return books. Otherwise I will send \$8 plus delivery charges then; and \$6 a month for 5 months. (Reg. price \$48, you save \$10.)

Name

Home Address.....

City & State.....

Employed by.....

We'll pay Delivery Charges if you enclose \$8 first payment WITH coupon. Same return privilege for full refund.

(Offer applies to U.S. only) RE-7

A transistorized GEIGER COUNTER

By **NATHAN O. SOKAL*** and **IRA L. RESNICK***

TOURIST gets \$10,000 for Uranium claim staked out with Geiger counter." Occasional headlines like this dramatize the fact that many vacationers now carry Geiger counters with them wherever they go.

If you don't plan to go in for modern-style treasure-hunting, this Geiger-Mueller counter (see photo) will at least make a pleasant project good for an evening's education in ionizing radiation physics, Geiger-Mueller tubes, and transistors, all in one fell swoop. And you *might* discover uranium in your own back yard!

Geiger-Mueller tubes

A Geiger-Mueller (G-M) tube¹ is a metal cylinder with a wire running along its axis, as shown in Fig. 1. The tube is filled with gas, and a high-voltage d.c. source, usually about 900 volts, is connected between the cylinder and the wire, the wire being positive. Ordinarily, there is no current flow in the tube.

Ionizing radiation—alpha rays (helium nuclei), beta rays (fast-moving electrons), gamma rays (electromagnetic radiation similar to light, but of much shorter wavelength), or cosmic rays (very fast-moving nuclei of hydrogen or other elements, or their by-products after passing through the atmosphere) — passing through the tube ionizes a gas molecule. The electron knocked out of the gas molecule travels to the center wire, and the now positively charged gas molecule travels more slowly toward the negative cylinder. The moving electron collides with gas molecules along its path, knocking electrons out of these molecules; these electrons in turn knock out others; within a few microseconds an electron "avalanche" has built up. The electrons and ions flowing inside the tube show up as a pulse of current drawn from the high-voltage source. The pulse for a typical G-M tube is shown in Fig. 2.

If an earphone is connected in series with the tube and the voltage source, as in Fig. 3, a faint click will be heard in the earphone each time a current pulse flows. The 1-megohm resistor in Fig. 3 is to limit the current drawn from the battery in case of an accidental short-circuit.

G-M tubes are made from about 1/2 inch to several feet in length, and with metal or metal-coated glass walls. Depending on the diameter and the gas inside the tube, the operating voltage

The transistorized Geiger counter. Resistor appearing beneath transistor was for experimental purposes and is not required for proper operation.

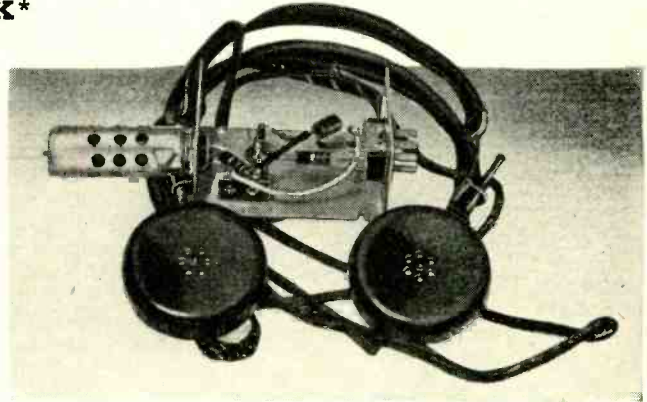

may be from about 300 to 1,200 volts d.c. The price ranges from about \$3 to several hundred dollars, depending on many factors. A good choice out of all these possibilities is the Raytheon CK1026 (used by the authors) which operates at 900 volts and costs \$3.15, or the Victoreen 1B88 which operates at 300 volts and costs \$5.

Transistor amplifier

A transistor amplifier can be added to the basic circuit of Fig. 3; the clicks will then be louder, making for easier listening. A circuit using a grounded-emitter amplifier is shown in Fig. 4. In this circuit, the current pulse from the G-M tube is drawn out of the transistor base. A similar pulse, amplified by the transistor, flows through the headphone in the collector circuit. The amount of amplification depends on the characteristics of the particular transistor, and on the pulse rise-time and duration. In the authors' equipment, the amplification was about seven times, using a CK721 transistor. A 2N34 or other good-quality p-n-p transistor would also be suitable.

High-voltage sources

The authors used batteries for their high-voltage source. Three Burgess U200 or Eveready 493 300-volt batteries in series give the 900 volts required for most G-M tubes.

A way to get the 900 volts without so

Parts for Geiger counter

1—CK721 or 2N34 p-n-p transistor; 1—Raytheon CK1026 or Victoreen 1B88 Geiger-Mueller tube; 1—chassis, 3 1/4 x 1 3/4 x 2 1/4 inches; 1—magnetic headphone set, 2,000 to 20,000 ohms; 3—Burgess U200 or Eveready 493 300-volt batteries. Or, one such battery and two 0.5-uf, 400-volt capacitors plus a 4-pole 2-position switch (Mallory 7242L). If the 1B88 tube is used, only one 300-volt battery is needed, without the capacitors and the switch; 1—6-volt battery; 1—d.p.s.t. switch; 1—7-pin miniature tube socket with tall shield; 1—high-voltage connector plug; 1—1-megohm, 1/2-watt resistor; 1—pin jack for phones.

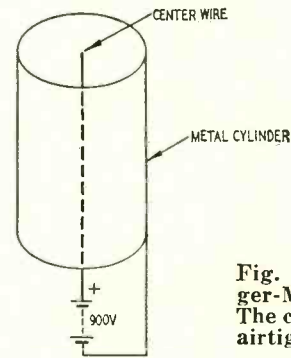

Fig. 1—Basic Geiger-Mueller tube. The cylinder has an airtight seal.

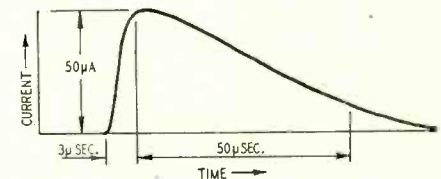

Fig. 2—Typical GM current pulse.

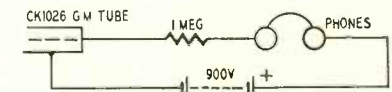

Fig. 3—The basic circuit. The earphones are in series with GM tube.

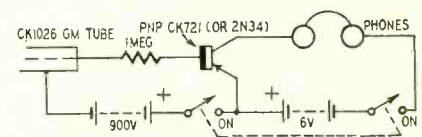

Fig. 4—Grounded-emitter amplifier.

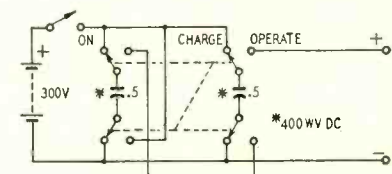

Fig. 5—A possible high-voltage source—using charged capacitors.

*Lincoln Laboratory, M.I.T.

many batteries is to use a single battery to charge two capacitors in parallel.² If the capacitors are then connected in series with each other and with the battery, you have a high-voltage source which decays slightly each time the G-M tube draws current. The larger the capacitance, the longer the unit operates between recharges. The capacitors and the battery can be connected to a 4-pole, 2-throw, nonshorting switch as shown in Fig. 5, giving the equivalent of a 900-volt battery from only a 300-volt battery and two capacitors. One switch position is used for charging the capacitors, and the other is for operation. Of course, the switches must be capable of withstanding the voltages placed on them.

High voltage can be obtained from the low-voltage transistor battery by using a vibrator, a step-up transformer, and a rectifier. Victoreen makes vibrators and rectifiers suitable for this purpose. (Note that 900 volts—especially from batteries—can be dangerous. Be careful!—Editor)

A transistor oscillator can be used instead of the vibrator; full details on such a unit are given by G. W. Bryan³ in an article in the *Proceedings of the I.R.E.*, November, 1952. A high-voltage power supply of this type is manufactured by Technical Operations, Inc., Arlington, Mass.

The CK1026 tube can be mounted in a 7-pin miniature tube socket by pushing the center wire through the hole in the center of the socket. A tall tube

shield (such as for the 6AQ5) holds the G-M tube in the socket. (Drill holes in shield to pass radiation.) A strip of spring copper can be fitted inside the shield to connect the shield (and thus the chassis) to the outside of the tube envelope, the negative connection for the tube. The negative side of the high-voltage source is also connected to chassis, thus completing the high-voltage circuit. Provide insulation between chassis and the headphones and transistor adequate for 900 volts, or else connect the positive side of the high voltage to chassis and insulate the negative connection of the G-M tube from chassis.

When soldering the transistor into the circuit, hold the lead with pliers between the transistor and the soldering iron to prevent damaging the transistor by excessive heat from the iron.

The headphones used in the authors' unit were 2,000 ohms impedance. Better results can probably be obtained with 20,000-ohm headphones if they are available. If the utmost in portability is desired, a hearing-aid earphone can be used instead of the larger headphones shown in the photograph. END

References

- ¹Korff, Serge A., "Electron and Nuclear Counters—Theory and Use," D. Van Nostrand Co. Inc., New York, 1946.
- ²Blanchard, Thomas A., "Pocket-Size Uranium Detector," *Radio-TV Experimenter*, Vol. 11, pp. 113-115, Science and Mechanics Publishing Co., 450 East Ohio St., Chicago 11, Illinois, 1952.
- ³Bryan, G. W., Jr., "Application of Transistors to High-Voltage Low-Current Supplies," *Proc. I.R.E.*, pp. 1521-1523, November, 1952.

A BETTER DRY CELL

In the February, 1944, issue of this magazine, Hugo Gernsback stated: "Many people, including technicians, do not know that in battery manufacture we can replace the zinc element with magnesium. When we do this something extraordinary happens—the voltage of the electric cell in which it is used appreciates considerably. Thus an ordinary dry cell, using zinc, which normally is rated at 1½ volts, rises to almost 2¼ volts with magnesium . . . I believe that by the time the war is over, this difficulty will also have been overcome."

It took technicians almost ten years to catch up with the above prediction. A magnesium cell has been developed. Its open-circuit voltage is about 2.05, a little lower than predicted. The original work was done by Drs. R. F. Kirk, P. F. George, and A. B. Fry, of the Dow Chemical Company, and in a letter to the Editor, they state as follows: "You did indeed anticipate well in advance a development which is now a reality and which we feel is on the threshold of widespread acceptance. The cells are now manufactured for portable radio batteries for the military. The 2.25-volt figure predicted by you was very close, our normal open circuit voltage being about 2.05. This varies with the alloy and cathode mix compositions and can be adjusted to give 2.25 volts." END

Windsor RADIO & TV RECEIVING **TUBES** GUARANTEED ONE FULL YEAR . . . FOR PEAK PERFORMANCE!

Type	Each	Type	Each	Type	Each	Type	Each	Type	Each	Type	Each	Type	Each
OA2	.90	IR4	.85	6AC5GT	.82	6BF5	.66	6Q7GT	.55	7A4/XXL	.57	12B7Y	.77
OB2	.88	IR5	.62	6AC7	.90	6BF6	.43	6R7	.75	7A5	.70	12J5GT	.48
OC3	.95	IS4	.67	6AF4	1.10	6BG6G	1.47	6S4	.51	7A6	.57	12SA7GT	.57
IA7GT	.67	IS5	.52	6AG5	.59	6BH6	.63	6S8GT	.75	7A7	.58	12SH7GT	.67
IAE4	.90	IT4	.62	6AH4	.68	6BJ6	.53	6SA7GT	.57	7A8	.56	12SK7GT	.55
IB3GT	.69	IU4	.61	6AK5	.89	6BK5	.76	6SC7	.63	7AD7	1.05	12SL7GT	.67
IH5GT	.93	IU5	.51	6AK5	1.05	6BK7	.97	6SD7	.55	7AF7	.63	12SN7GT	.59
IJ6	.93	IV2	.45	6AL5	.44	6BK7	.97	6SE7	.55	7AH7	.65	12S07GT	.46
IL4	.63	IX2A	.74	6AN8	.95	6BL7GT	.94	6SF5GT	.66	7AG7	.65	12V6	.51
IL6	.66	2X2	1.43	6AQ5	.51	6BN6	.98	6SH7GT	.52	7AJ7	.70	12V6GT	.46
ILA4	.80	3LA5	.90	6AQ6	.47	6BO6GT	.98	6SJ7GT	.52	7B4	.54	12V6GT	.46
IL6	.80	3LF4	.76	6AQ7	.75	6BY5G	.85	6SK7GT	.55	7B5	.51	12V6GT	.46
ILB4	.82	3Q4	.66	6AR5	.42	6C4	.41	6SN7GT	.59	7B7	.58	12V6GT	.46
ILC5	.80	3Q5GT	.72	6AS7G	4.50	6C5GT	.60	6SQ7GT	.46	7C4	1.05	12V6GT	.46
ILC6	.80	3S4	.61	6AT6	.42	6C6	.58	6T8	.85	7C5	.56	12V6GT	.46
ILD5	.80	3V4	.62	6AU5GT	.85	6CD6G	2.04	6U4GT	.60	7C6	.50	12V6GT	.46
ILE3	.80	5R4GY	1.00	6AU6	.47	6D6	.63	6U5	.72	7C7	.58	12V6GT	.46
ILG5	.80	5U4G	.44	6AV5	.85	6E5	.72	6U8	.86	7E5	.85	12V6GT	.46
ILH4	.80	5V4G	.83	6AV6	.41	6F5GT	.54	6V3	1.09	7E6	.65	12V6GT	.46
ILN5	.80	5Y3G	.37	6AX4	.72	6H6GT	.55	6V6GT	.51	7E7	.85	12V6GT	.46
ILN4	.80	5Y4G	.43	6B8G	.93	6J5GT	.44	6W4GT	.50	7F7	.69	12V6GT	.46
IN34	.50	5Y3GT	.32	6BA6	.50	6J6	.68	6W6GT	.63	7F8	.85	12V6GT	.46
IN48	.50	5Y4G	.43	6BA7	.66	6J7	.70	6X4	.37	7G7	.85	12V6GT	.46
IN5GT	.63	6A8GT	.68	6BC5	.58	6K6GT	.45	6X5GT	.36	7H7	.61	12V6GT	.46
IN64	.75	6A84	.51	6BD5GT	.98	6K7	.70	6X8	.82	7J7	.85	12V6GT	.46
				6BD6	.54	6L6G	.88	6Y6G	.64	7K7	.85	12V6GT	.46
				6BE6	.51	6L6GA	.88	6ZY5	.60	7L7	.85	12V6GT	.46

WINDSOR "WONDER-BEAM" 3-WAY TV ANTENNA

For Average Areas, Fringe Areas and UHF, Adjustable arms, and new electronic wonder-switch for optimum performance with any TV set! **SPECIAL PRICE, Lots of Six, Each \$5.69**

Singly, each \$5.95

FREE! WINDSOR TUBE CADDY

Most practical service-aid ever designed for Radio & TV repairmen! Now offered FREE with every purchase of \$10.00 or accumulated purchases totaling \$10.00 within 90 days. (You get Caddy credit memo with each purchase).

- Carries approximately 125 tubes including meters and tools.
- 16 3/4" Long, 8 3/4" Wide, 13 3/4" High. Weighs only 9 lbs.
- Ruggedly constructed with heavy leatherette covering, strong plastic handle, nickel plated hardware, and reinforced with metal clamps.

WINDSOR TUBE CADDY MAY ALSO BE PURCHASED OUTHRIGHT FOR \$14.95.

Note to our Latin-American Friends: "Se Habla Español"



WINDSOR "BROW-LITE"

LEAVE BOTH HANDS FREE TO WORK!

World's most useful flashlight! Ideal for Radio & TV Repairmen. Uses standard penlite batteries and bulb. Won't interfere with glasses, rides above them over the brow. Complete with Batteries. **\$4.95**

Windsor ELECTRONIC TUBE CO.
2612-C NOSTRAND AVENUE, BROOKLYN 10, N. Y.

Write for Additional Tube Types and Prices. We also stock Special Purpose and Transmitting Tubes at Similar Savings! Dept. N-7.

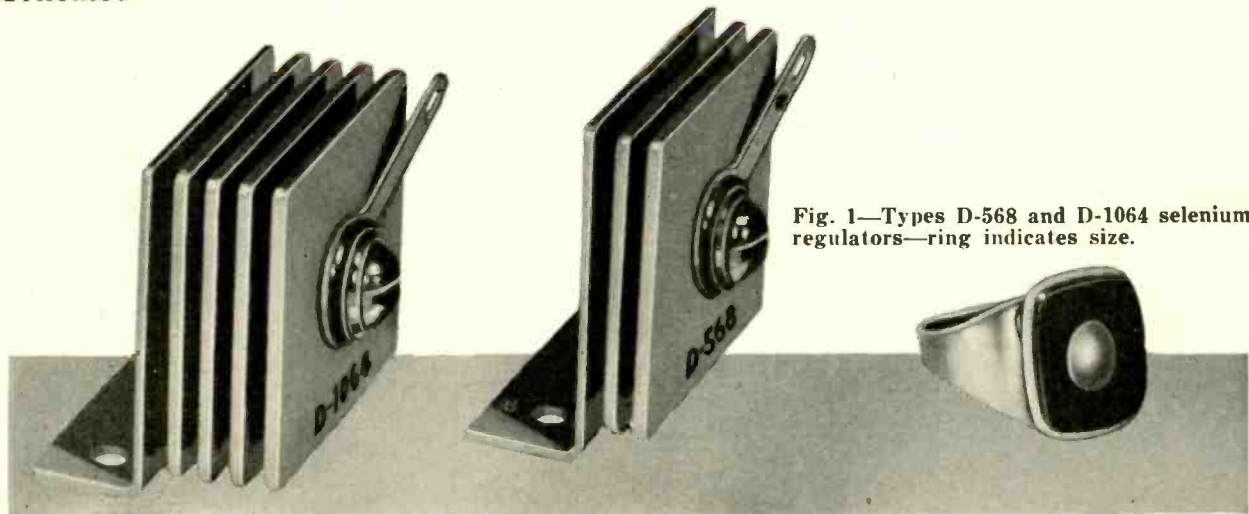

Fig. 1—Types D-568 and D-1064 selenium regulators—ring indicates size.

selenium regulators

*Voltage stabilizing units
with constant characteristics*

By J. T. CATALDO*

SELENIUM rectifiers have often been used as voltage regulators. But design engineers have had trouble getting out production quantities of the units. The main difficulty has been to duplicate the characteristic curves of the rectifiers. As a solution, a series of three units have been developed, each having slightly different characteristics which can be readily met in production quantities.

Two of these selenium voltage regulators are shown in Fig. 1. They have been photographed with a man's ring for comparison purposes. Three general types of voltage regulators are available: D-568, D-923, and D-1064. Table I shows the nominal voltage they will regulate. A test circuit is shown in Fig. 2. This is a simple d.c. series circuit using a 6-volt battery as the potential source. The forward characteristic of the unit can be plotted by setting the voltage values given in Table II for the particular unit and recording the forward current. The voltage regulation required is determined by the forward characteristic curve plotted with the above data.

Types D-568, D-923, and D-1064 are recommended for the regulation of d.c. voltages in the order of 1.5, 2.0, and 3.0, respectively. These units are regular production items consisting of two or more specially processed selenium plates, connected in series on a mounting bracket, and make up the basic design of a series of selenium regulators for various voltages. It is possible, by the addition of more plates in series, to assemble selenium regulators for

regulation of higher voltages than those mentioned.

In operation, the selenium regulator is shunted across the load, with a voltage-dropping resistor in series with the source voltage and load as shown in Fig. 3. Regulation is obtained by using the forward characteristic shown in Fig. 4. When the regulator is connected in this manner, the voltage across the voltage-dropping resistor (R) varies inversely with changing load current, and the desired voltage is maintained.

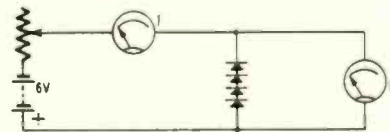

Fig. 2—Circuit to determine forward characteristic of selenium regulators.

For example, when the voltage is 1.5, a current of approximately 125 milliamperes flows through the regulator. If, in the operation of the equipment, the load current is decreased, the output voltage may rise to, say, 1.8. With this voltage across the regulator, the current flowing through it will be approximately 220 ma. However, a cur-

rent drain of 220 ma causes a larger voltage drop across R, and the output

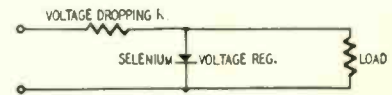

Fig. 3—Circuit shows selenium regulator used with voltage-dropping resistor.

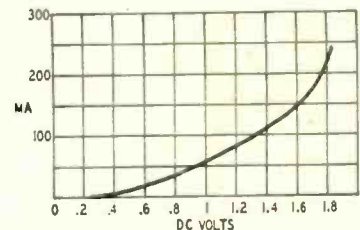

Fig. 4—The forward characteristic of type D-568 selenium regulator.

Table I—Selenium Regulators

Type	Nominal Voltage
D-568	1.5 v d.c.
D-923	2.0 v d.c.
D-1064	3.0 v d.c.

Table II—Forward Characteristics

Type D-568		Type D-923		Type D-1064	
Test Voltage	Current in ma	Test Voltage	Current in ma	Test Voltage	Current in ma
1.2	92 max.	1.5	160—270	2.4	90 max.
1.5	125—185	2.0	310—600	3.0	120—185
1.8	220 min.			3.6	220 min.

*Asst. Gen. Mgr., International Rectifier Corporation

voltage drops to its normal value. On the other hand, if the load current is increased, the output voltage may drop to, say, 1.2. At this voltage, the regulator will draw approximately 80 ma, causing a lower voltage drop across R, thereby increasing the output voltage. R can be designed to drop the necessary voltage to maintain the 1.5 volts within certain tolerances.

These selenium regulators fill a much desired need for a component to regulate low voltages in the order of 1.5 to 10. They are currently being successfully used in both military and commercial equipment. **END**

NOISE GENERATOR

The junction type CK722 transistor may be used as a noise generator to provide signals over a wide spectrum (see diagram).

The circuit, a Hartley type, uses a high base resistance and small capacitor. Evidently it superregenerates and sets up sidebands on either side of the carrier. This carrier is determined by the tank coils. In this case I have chosen 900 kc. The tank is slug-tuned and no shunt capacitor is added. On either side of 900 kc numerous sideband signals may be heard. They are spaced approximately 10 kc, and extend to about 200 to 250 kc on either side of the carrier.

In the broadcast band, the individual sidebands may be distinguished from each other. As we tune, one sideband after another comes and goes. On the higher frequencies, the sidebands tend to merge or blend. For example, signals are heard at 1800 kc, 2700 kc, etc. On each side of these harmonic carriers, the sidebands generate a veritable bed-

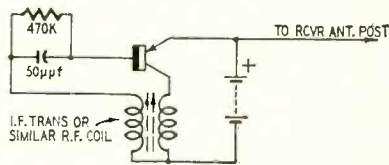

lam. It is like a half-dozen air-raid sirens wailing at once, each with a different pitch. Of course, these tones do not change unless the tuning is varied.

On the shortwave bands, the noise appears at every 900 kc. A tuning meter shows an increase in noise until a maximum is reached at the harmonic of 900 kc, then there is a gradual decrease down to zero. At any point within this region, there are many simultaneous whistles, and the receiver may be tuned, adjusted, or aligned. No other modulation is needed from the generator.

With a more sluggish transistor, it may not be possible to use a carrier frequency as high as 900 kc. Then the circuit should be set for some lower frequency. Some transistors may also require a higher voltage, but I found that satisfactory results are obtained with as little as 3 volts.

The connection to the emitter seems to be necessary. It may be either a direct connection to the receiver antenna post or a long lead left floating near it. —I. Queen

JULY, 1954

A fascinating field! A great future! A good job or independence in a business of your own! TV is growing by leaps and bounds —1227 new communities, 1845 new stations given "go-ahead". Trained men are worth their weight in gold!

COYNE HAS TRAINED MORE SUCCESSFUL MEN

Thousands of successful men trained at COYNE—the largest, oldest, best-equipped school of its kind (established 1899). A Coyne-trained man is a top-trained man. Coyne methods require no advanced education or previous experience.

TRAINING TAILORED TO MEET YOUR NEEDS

Resident Shop Training—You can learn on real equipment in the Great Shops of Coyne. Learn quickly-easily at Coyne. Practical Technical method gives practical experience on massive outlay of full-size equipment plus necessary technical training. Finance Plan whereby you can enroll now and pay most of tuition later. Also Monthly Payment Plan especially designed for K-Vets. If you need part-time work to help out with living expenses while at COYNE, we'll help you get it. Coupon brings FREE BOOK and details.

OR

Coyne Tested Home Training—To those who cannot come to the Coyne shops here in Chicago, we offer modern, up-to-the-minute training designed to meet Coyne standards. Practical, down-to-earth, easy to follow, step-by-step instruction. So practical, you can quickly be earning money in

B. W. COOKE, President **FOUNDED 1899**



500 S. Paulina Street, Chicago 12, Dept. B4-TR4
ELECTRICITY • RADIO • TELEVISION • REFRIGERATION • ELECTRONICS

Television and Radio while learning—personal supervision by Coyne Staff—men who know TELEVISION AND RADIO, AND KNOW HOW TO TEACH IT—and the cost is low—you pay only for training—no costly extras. Send coupon below for Picture Folder and full details, including easy Payment Plan.

MAIL COUPON FOR FREE INFORMATION

Fill in and mail coupon, TODAY. Check the training you're interested in. If you want information on both, check both. Complete details will come by return mail. No cost—No obligation—No salesman will call.

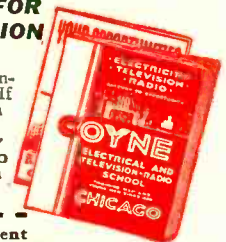

B. W. COOKE, President
COYNE ELECTRICAL SCHOOL
500 S. Paulina Street, Chicago 12
Dept. B4-TR4

Send details of your offer on training checked below. This does not obligate me and no salesman will call. I am interested in:

- TELEVISION-RADIO HOME TRAINING
- TELEVISION-RADIO IN COYNE SHOPS

Name

Address

City State

RECEIVING TUBES

THREE TOP BRANDS ONLY AT TREMENDOUS SAVINGS OVER REGULAR WHOLESALE

OTHER TUBES AVAILABLE AT SAME LOW, LOW PRICES

Latest Code Dates • Boxed • Fully RTMA Guaranteed				Brand New Pix Tubes Full One Year Guarantee			
				JULY SPECIAL! 16RP4 14.95 WITH OLD TUBE			
				With Old Tube		With Old Tube	
OZ4 .62	6AK5 1.30	6BQ7 1.42	12AU7 .85	10BP4 ...10.45	9.95	16GP4 ...20.45	16.95
1B3 .95	6AL5 .63	6BZ7 1.52	12BA6 .73	12LP4 ...12.95	11.95	16RP4 ...17.95	14.95
1X2 1.06	6AQ5 .76	6CB6 .76	12BE6 .78	12LP4A ...14.50	11.95	17BP4 ...20.95	16.95
5U4 .63	6AU6 .67	6J6 .92	12SA7 .80	12QP4 ...12.95	11.95	17CP4 ...20.95	17.95
5Y3 .48	6AV6 .60	6K6 .65	12SK7 .77	14CP4 ...14.95	13.95	19AP4 ...23.45	19.95
6AB4 .80	6BA6 .71	6SN7 .85	12SQ7 .67	15AP4 ...15.95	14.95	19AP4A ...23.95	19.95
6AC7 1.25	6BG6 1.98	6V8GT .75	35W4 .49	16AP4 ...18.45	16.95	20CP4 ...25.45	19.95
6AG5 .83	6BK7 1.28	6W4 .70	35Z5 .51	16CP4A ...19.45	15.95	20HP4 ...26.95	20.95
6AH6 1.40	6BQ6 1.42	12AT7 1.05	50L6 .75	16DP4A ...17.45	15.95	21EP4 ...26.95	20.95
				16EP4A ...20.45	16.95	21AP4 ...26.95	21.95
				16FP4A ...17.45	15.95	21FP4 ...27.95	21.95

Send for FREE catalog of additional tubes and parts

STUART ELECTRONICS DISTRIBUTORS 149-09 Union Turnpike, Flushing 67, N. Y. Olympia 8-3553, 4352
Dept. E-7 Minimum Order \$10.00

TERMS: 25% Check or Money Order, Balance C.O.D., F.O.B. New York. Satisfaction Guaranteed or money back in 10 days.

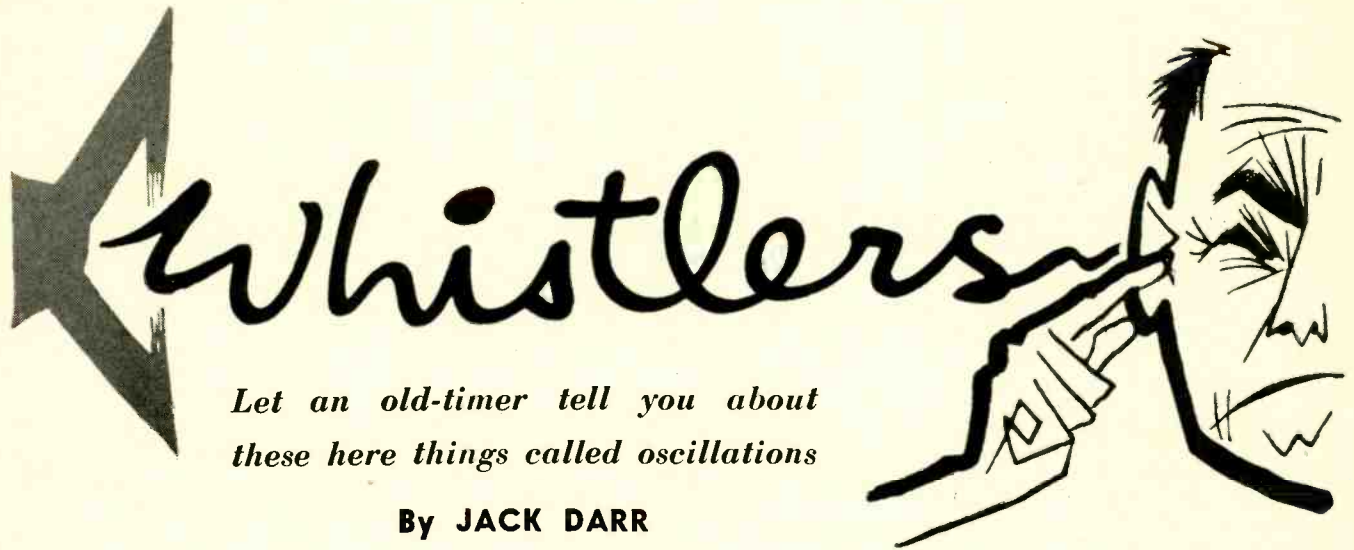

Whistlers

Let an old-timer tell you about these here things called oscillations

By JACK DARR

"WELL sir, I'll tell you . . ." said the Old-Timer, leaning back from the bench and digging out a cigarette. "There's lots of things in this business that'll puzzle you, and one of the best of 'em's oscillations. Whistlers, that is."

"Whistlers?" asked the young Ham, his assistant. "You mean like this?" and he gave a long piercing wolf-whistle.

"Nope, though I wouldn't be surprised if I find one some day that did. No, what I meant was oscillation."

"Oscillation, like in a transmitter, or in a superheterodyne? I thought all radios had to have them."

"Oscillations, plural, not oscillator, singular, though some of 'em get plural oscillations, and they sound most singular."

"Ugh!" groaned the young Ham. "If the trouble is as bad as your jokes, no wonder they're tough!"

"They're worse at times," said the Old-Timer. "Here. This one just came in. See if you can locate the trouble in it." He turned the switch on an old Philco sitting on the bench. As it warmed up, it began a loud, plopping sound, at about two cycles-per-second. "Now, then, what's that?"

"Sounds like a motorboat," ventured the young Ham.

"Yep. That's the trade name for it. Now, little man, what is it, and what causes it?"

"Well, it's—sounds like—Oh, I don't know."

"Good, glad to hear you admit it. One of the best things a radioman can do is admit to himself, once in a while, that there is a little something he ain't found out as yet! That's motor-boating, like you said. It's a slow audio oscillation, resulting in a popping sound."

"But, I thought oscillations couldn't be heard, like r.f. and—"

"Whoa! Define me an oscillator. Just any old oscillator. What does it do?"

"Well, it's a generator of alternating

current. That's what you always want me to say, ain't it?"

"Correct! Now ain't that an alternating current? It ain't d.c., is it?" grinned the Old-Timer.

"Yes, but it's awful slow, and—"

"Don't recollect saying anything about how fast a.c. had to alternate, did I? As long as it's true a.c., it can be anything from one cycle up to umpteen megacycles, can't it?"

"Yes, but—"

"Now, remember, an oscillator can generate any frequency in the book, as long as the proper conditions exist, and what are they?"

"The feeding back of a signal from the output circuit into the input circuit in the proper phase to sustain oscillations" recited the young Ham, all in one breath.

"Correct," smiled the Old-Timer. "Now, turn the page. Tell me what determines the frequency of an oscillator."

"Why, the size of the coil and capacitor, isn't it?"

"Well, let's say all the inductance and capacitance in the whole circuit, takin' 'em all together. In other words, the sizes of the capacitors and other stuff all around this particular circuit will kinda tell you what frequency you're gonna get out of it. Now, let's get back to our old Philco. This is a slow oscillation, so we might kinda suspect that it is in the audio stages. Biggest components are there. Not like the r.f. and i.f. end, where the bypasses run smaller. In this set, and in all other similar a.c. sets, meanin' ones with a power transformer, not an a.c.-d.c., the output filter capacitor, right here, is the major cause of this kind of trouble." He turned the set over, and indicated a large can-type electrolytic. "Now, don't go and assume that it is the *only* cause of it; you're headin' for trouble if you do. You can have a similar trouble originatin' at any of three or four places in the circuit. This is just the most likely, so that's the place you oughta check first.

Look here now." He picked up a large piece of scratch paper, and rapidly sketched a diagram (Fig. 1). "Here's a partial schematic showing the d.c. circuits of any radio receiver. Here's the filter. Let's mark it No. 1, and then see how many other places we can find that would give us trouble."

He stirred up a pile of stuff on the bench, coming up with a tubular capacitor. "Let's check this first. Here's a 16-mike, at 450 volts. Always use high-voltage capacitors on these. You're not working on an a.c.-d.c. now, with their 150-volt capacitors. Let's try it." He shunted the new capacitor across the suspected one, and the motorboating stopped. "There. See now, if I take it out, the noise starts again." The popping began again. "Now, let's fix it while we got 'er here. Hand me the dykes."

He clipped the wires leading to the old capacitor, and carefully installed the new one. As he was soldering the wires, the Young Ham asked, "Why can't you just stick that across the other one and leave it?"

The Old-Timer looked at him reproachfully. "Now, ain't I taught you better'n that? That's a sloppy way to do it, and besides, you're takin' a risk leaving the old one in the circuit. No tellin' what might happen to it. No, sir! Always cut the bad unit clear out of the circuit. If I catch you leavin' any in, I'll fan you. If this was a dual or even a triple unit, we'd cut the whole thing out, even if only one section was bad."

"But why?" asked the young Ham. "Looks like you're taking out good parts. Why not leave 'em in there until they go out, too?"

"That's just the point," replied the Old-Timer. "There's no tellin' how long they'll last, and you're eliminatin' one of the major causes of call backs if you remove 'em."

"But," puzzled the young Ham, "why did that capacitor cause the set to oscillate in the first place?"

"Ain't you figured that out yet?" asked the Old-Timer. "Look. What was

wrong with that capacitor? Was it shorted?"

"No, if it had been shorted, it'd burn something up," replied the young Ham.

"Correct. Therefore, it musta been open, bein's as how there's only two things that can be wrong with a capacitor. If it's open, what effect will it have on the circuit?"

"Well, it'll be the same as if you took it out entirely, won't it?" said the young Ham.

"Right! Take it out of the circuit, and it'll have a mighty small filtering or bypassing effect, eh? Now, look here. (Fig. 1). See this last audio plate return and this first audio return, and even all these r.f., mixer and i.f. plate returns? They all come back to the same place, don't they? If you have signal currents from all these stages comin' right back to here, what's to keep 'em from gettin' mixed up, and feedin' back into somewhere they ain't wanted? You gotta have something to run 'em off to ground, and that's where this capacitor comes in."

"Yes, but you told me that a capacitor was always an open circuit," puzzled the young Ham.

"Junior. You just ain't been listenin'. I said it was an open circuit for d.c., not a.c. This big fat capacitor's a short circuit for any signal currents that get down here. Takes 'em right back to chassis, or ground, and they don't bother us. Now, without it, some of 'em feed back up into other stages, and then we've got oscillation. See? Now, there's other troubles comin' from that filter, too, besides motorboating. Let's see. I saw one come in this morning that sounded like it might be—here it is." And he picked up a small 1.4-volt battery set. Hooking it up to the bench power-pack, he connected a signal generator to it, and began aligning the i.f. trimmers. "Now, listen. See if it'll do what I think it's gonna."

The alignment proceeded normally until he reached the last trimmer, when the little set burst into a loud squeal, changing in pitch as he turned the trimmer. He backed off the trimmer, and the squeal stopped. He cocked an eye at the young Ham.

"There you are, Buster. What's that, and what causes it?"

"Don't tell me! Lemme guess! It's oscillation!"

"All right, smart-aleck, it's oscillation. Now, where and why?"

"Well, it's a high-pitched squeal, so it's probably in the i.f. or r.f. Is the

output filter open there, too?"

"That was a guess, wasn't it?" The young Ham grinned but said nothing. "Well, it was a good one. That's what it is. Only thing, in this set, it's the only filter capacitor, because it's a battery set. Now, you get the same thing in the small a.c.-d.c.'s, because they use the output filter capacitor there to filter, and also to bypass the audio, i.f. and everything else. If it opens up, you'll get oscillations in the i.f. stage—sounds just like these. Reason she didn't show up here until I reached the last stage, the signal voltage that I was developin' across the returns didn't get high enough to feed back until I got almost all of 'em peaked; then it got big enough to feedback, and she spilled over." He disconnected one lead of the filter capacitor, and hooked it to the capacitor tester. "Yep, there she is. Reads about one mike, and look at the power factor. Clear over to 50, and the eye isn't open yet. Power factor in an electrolytic, is the ratio of the leakage current to the capacitance, roughly speakin', and the higher the power factor the lower the filtering efficiency, so there you are. If you want to be real sure, you can replace any capacitor that shows above 20 on the power-factor dial, but that's cuttin' 'em a mite close. Best clue is the way the set acts."

"But, how can you tell for sure when a capacitor needs replacing?" asked the young Ham. "You're always telling me that I shouldn't ever replace any unnecessary parts in a customer's radio. How are you gonna tell?"

"Son, the best judge of that is the set itself," replied the Old-Timer. "If it's squealin' loud enough for you to hear distinctly, there ain't a doubt about it. If you feel any doubt in your mind as to whether that squeal is actually there or not, or if the thing has a kinda 'fringe-howl', tuning from station to station, try this. It'll set your mind at rest." He swiftly hooked up an oscilloscope and signal generator to a little a.c.-d.c. next in line. While he waited for them to warm up, he continued. "Scope hooks across the volume control, signal generator to the mixer grid. Feedin' in an FM signal at the i.f. frequency, swept about 30 kc. That gives us what?"

"The response curve of the i.f. stages?"

"Correct! Didn't think you was listenin'. Now, look here." And he pointed to the response curve appearing on the face of the scope. "See how this curve

is kinda ragged down here on the left side? (Fig. 2-a). One side looks pretty good, but the other side breaks up at the baseline. That's oscillations. That set'd play pretty good, but you'd have a fairly loud hiss when you crossed each station. You can't tune that out, neither, not with an AM signal and an output meter. Only way to get it out is to use a scope and a FM signal, and round up the curve till it looks right. Now, could be that this is caused by a low filter capacitor, or something. You can shunt 'em with a good one, while you've still got the scope hooked up, and see, right fast. Also, that condition might be caused by an open a.v.c. bypass, here, (Fig. 1, No. 2) or a B-plus bypass, here, (Fig. 1, No. 3) or a screen bypass, here. (Fig. 1, No. 4) Best way

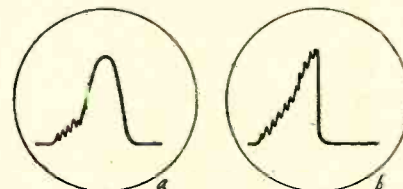

Fig. 2—Indications of oscillation.

to find out is to try shuntin' 'em with good capacitors. If none of these helps, tune the set for a good round curve, and you've got it. Now, a set that's oscillatin' worse than this one will look something like this," and he sketched a curve. (Fig. 2-b.) "This one's in bad shape. Might be filters, or several things. If you try everything, and still got troubles, try changin' the i.f. amplifier tube. Sometimes that'll get it when all else fails. Don't pay no attention to what the tube-check says, either. A tube that tests perfectly good can oscillate in the i.f. stage of some sets."

"Is any type of set worse than others on that?" asked the Young Ham.

"Don't seem to be," opined the Old-Timer. "I've had 'em all do it, from battery sets to car radios, and they'll all take spells of it. If the set has an r.f. stage, chances are it has the same tube type in it, like 12BA6's in a.c.-d.c.'s, so just try swappin' 'em. That works, lots of times. See?"

"I'm beginning to catch on—I think," said the young Ham, thoughtfully. "You mean that there are several causes of oscillation, and that you have to know all of them, and just keep on trying until you find out which one is actually causing the trouble?"

"Hooray! You're gettin' better all the time," cheered the Old-Timer. "I'm beginnin' to have hopes for you. Locatin' trouble of any kind in a radio, amplifier or TV set, is just a matter of thinking of all the possible causes, and checking them out one at a time until you hit the right one. Sometimes you'll get some dillies, too. Remember that TV set I had a few weeks back, with the video i.f.'s oscillating?"

"I remember that one!" grinned the young Ham. "That was the day you just sat there at the bench, beating yourself

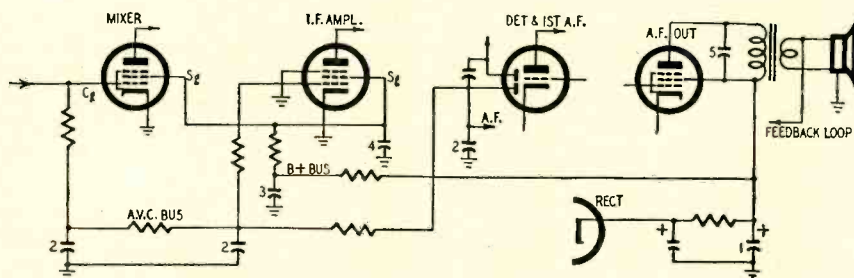

Fig. 1—Schematic shows several sections of a typical a.c. receiver.

Save trouble-shooting time
—with this amazing continuity checker
and voltage indicator



This ingenious new pocket tester was designed especially for the service technician. Ideal for field-testing shorts, grounds and opens in power transformers, selenium rectifiers, vibrators, switches and pilot lights and for voltage on plates, screens and filaments. Slip it into your pocket for quick and accurate on-the-spot testing.

Used successfully by

technicians at:
Beckman Instrs.
General Electric
Helipot Corp.
I.B.M.
Motorola
Sandia Corp.
Strömberg-Carlson
and many others
ONLY \$3.95 ppd.
No C.O.D.'s. ORDER
YOURS TODAY
Jobber inquiries invited
Present Owners: Get
more out of your
Circuitracer — write
for new instruction
book "Tracer Tips"

**CHECK THESE
UNIQUE FEATURES**

- For use up to 600 volts
- External or self-contained batteries
- Tests dead or live circuits
- Probe for low voltage live circuits
- Compact, lightweight (2½ oz.), rugged
- **MONEY BACK GUARANTEE**

DESCO MFG. CO.

603 E. WALNUT, PASADENA 1, CALIF.

**Concord
VEE-DX YAGIS**
Less Than
Manufacturer's Cost!

It may sound like bragging... but, we've made the most sensational Antenna buy of the decade, and we're passing the savings on to you. Here is an assortment of the finest VEE-DX you. Here is 8 element all aluminum yagis that DX 4 and 8 element all aluminum yagis that are priced in many cases at less than manufacturer's cost. We don't have a full selection of all channels in all types, so order early and assure yourself of an adequate supply of yagis at give-away prices.

4 Element
All-Aluminum Yagis

Channel 7, 8, 9
List \$8.50

\$1.98 EACH

\$1.75 Lots of 3

8 Element
Vee-DX Long John Yagis

Channel 5
List \$25.80

\$7.95 EACH

\$7.50 Lots of 3

Channel 9, 10, 13

\$4.50 ea. \$4.15 Lots of 3

FREE! NEW 1954 CATALOG!

A complete, comprehensive listing of all your electronic requirements. Bursting with SPECIAL VALUES



Dept C7

CONCORD RADIO

20% deposit with C.O.D.

Send new 1954 CONCORD CATALOG!

NAME _____

ADDRESS _____

CITY _____

ZONE _____

STATE _____

**CONCORD RADIO • 54 VESEY ST.
NEW YORK 7, N. Y. • Dlgby 9-1132**

on the head and yelling, 'But a stagger-tuned i.f. can't oscillate! It can't!' I thought you were going to flip, that day!"

"So did I!" admitted the Old-Timer, with a rueful grin. "I'd checked every possible thing in that i.f. strip; every capacitor, tube, and coil in or around it, and still it oscillated. Couldn't get myself to admit that it was all right and the trouble was somewhere else. Finally found an open coil in a little 4.5-mc trap, clear on past the video detector stage!"

"Why did that cause it to oscillate?" asked the young Ham. "We just agreed that for oscillation to take place part of the output of an amplifier stage would have to be fed back in phase with the input—and an open 4.5-mc trap wouldn't do that!"

"Well, near as I can tell, the strong signal from the video i.f. was going on through the detector, striking the infinite impedance of this open circuit, and 'bouncing' back into the i.f. in just the right phase to cause it to spill over. If you remember, it acted just like that little a.c.-d.c., just now. It didn't spill over into oscillation until I got to the last adjustment. By then, the signal voltage was so big that it fed back and started the oscillation. Anyhow, we fixed the coil, and that fixed the set. I'm happy!"

He turned the a.c.-d.c. receiver off, and started to move the battery set aside, when it began a steady medium pitched howl.

"What's that?" asked the young Ham. "That's oscillation, too, isn't it?"

"Yep. That's an easy one. See here?" and he pointed to the speaker leads lying across the 1H5 tube. "This is the second detector and first audio, unshielded, and the speaker leads gettin' that close to it makes enough feedback to cause that howl. Listen to it, now, so you'll remember it. You can get the same thing from gettin' the plate leads of the audio tubes dressed too close to a volume control, and so forth. Say, by the way, you can get one that sounds something like that from getting the leads mixed up on a replacement output transformer, if the set happens to have inverse feedback, and the feedback voltage is taken from the voice-coil winding of the output transformer. If you get one of them, and notice an extra wire running from the secondary winding back into the chassis, that's usually what it is, and you have to be careful. If it howls when you first turn it on, reverse the secondary leads; that'll usually stop it.

"Here's another funny one. Look here. (Fig. 1, No. 5) Here's a little capacitor that's put in there to improve the tone on lots of sets. Connected right across the primary winding of the output transformer. If that opens up, you may get a supersonic oscillation in the transformer and the power tube, and that'll upset your apple cart as far as tone is concerned. You can't hear the oscillation itself; seems to be up around 25 or 30 kc, but you can tell it's there, all right."

"How?" asked the young Ham, interestedly.

"Well, first, you'll notice a heavy distortion, like you had a heavy overload on some stage. If you measure the power tube grid voltage with a v.t.v.m., you'll get a whackin' big voltage, negative! Not positive, like a leaky coupling capacitor, but negative. This indicates that the tube is oscillating. If you hook a scope across it, you'll see it; it'll really put up a big pattern. Another cause can be a badly mismatched output transformer. Even if that's the one that was on it when the set came in, check it; somebody else mighta put on the wrong one by mistake. Of course, that sort of thing never happens around here."

"What, never?" said the young Ham, slyly.

"Well, hardly ever," replied the Old-Timer. "I like Gilbert and Sullivan too.

"Here's a couple more for you. See this metal tube here?" pointing to a 6K7 in the i.f. socket of the old Philco. "See that little metal strip there, soldered to the chassis? I had to put that on, last time it was in here. I replaced the 6K7-G with a metal tube, and it oscillated. Ordinarily, a metal tube doesn't need shielding, but this particular socket didn't have any connection to pin 1, which is where the shell of the metal tube is grounded. I slipped on this little grounding clip, and tacked it to the chassis, to ground the shell. Oscillated something like it did just now; kinda motorboated. In fact, I looked to see if that clip had come loose, first thing."

"If the tube has a shield, you don't need to do that, do you?" asked the young Ham.

"Nope. I had to take the shield off this one, though, so I could get the new tube in the socket. The shield base was too small. Now here's one more, and we'll go git a cuppa cawfee. See this little set with the loop, this a.c.-d.c.? Lots of 'em built like that. See that metal shield up the back of the chassis, about as high as the top of the tubes? Without that, most of 'em will have a tendency to burble and oscillate down around the low end of the dial, around 550 kc. If you catch one that does, try puttin' on this shield; ground it to the chassis, and don't let it get too close to the loop. If you do, it'll detune it, and you ain't got any too much gain to throw away on these sets. Better still, take the dern loop off entirely and install one of those little Loopsticks. Generally gives you more gain, and that always helps."

The Old-Timer stretched, and fumbled for another cigarette. "Well, that's about enough school for today. Let's go git that cawfee. I—where are you?"

A voice from outside the door inquired impatiently, "Well, are you comin' or ain't you?" Grinning, the Old-Timer lit the cigarette, and ambled out the door. Up the block, he caught a glimpse of the young Ham as he rounded the corner, already halfway to the coffee shop. **END**

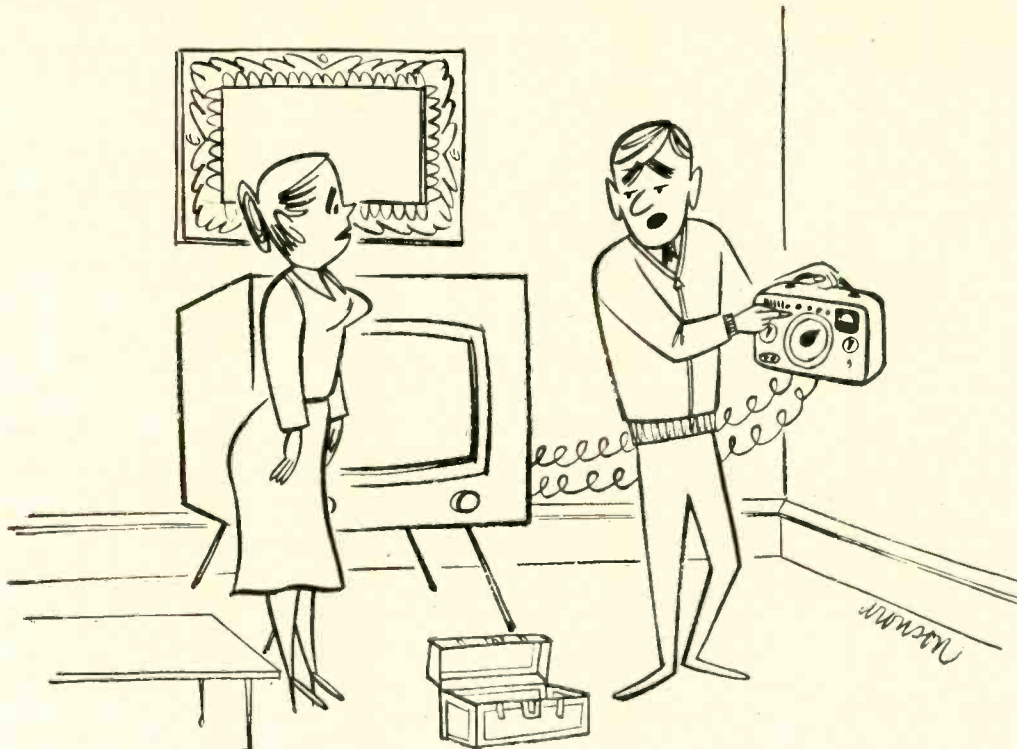

IT SAYS IT WANTS BETTER PROGRAMS AND SPRAGUE CAPACITORS.

Don't Be Vague... Insist on SPRAGUE



**Insist on Sprague
TWIST-LOK[☆] 'LYTICS**

Sprague TVL's fill the top performance bill in the toughest TV circuits. High temperatures, surge voltages, ripple currents won't faze them. Like all Sprague capacitors, Twist-Lok 'Lytics are your first line of defense against expensive call-backs.



**Insist on Sprague
TEL-OHMIKE[®]**

This capacitor-resistor analyzer is the handiest instrument you can buy! Moderately priced for radio and TV repair shops, the Model TO-4 Tel-Ohmike offers top quality and accuracy for every service need. Priced so you can afford it at **\$73.50_{NET}**



**Insist on Sprague
ATOMS[®]**

The smallest TV 'lytics made—and the only small ones for 85°C (185°F) up to 450 volts d-c. Guaranteed for low leakage and long shelf life, they withstand high temperatures, high ripple currents, high surge voltages. From crowded TV chassis to jam-packed portables, Sprague Atoms fit 'em all.

Accept no substitutes. There is a Sprague Distributor in every sales area in the United States. Write for the name of your nearest source of supply today.

☆ Trademark

SPRAGUE

Get your copy of Sprague's latest radio and TV service catalog C-610. Write Sprague Products Company*, 81 Marshall St., North Adams, Mass.

*Distributors' Division of Sprague Electric Company

**WORLD'S LARGEST
CAPACITOR MANUFACTURER**

N.J.R.T. TUBES 70% to 90% OFF LIST

GUARANTEE

ALL NJRT TUBES ARE BRAND NEW AND FULLY GUARANTEED FOR ONE YEAR

Type	Price	Type	Price	Type	Price	Type	Price	Type	Price	Type	Price
1A7GT	.45	6AF6	.75	6BF5	.55	6SA7GT	.41	12A7	.35	25B06GT	.75
1B3GT	.67	6AG5	.49	6BG6G	1.20	6SB7Y	.76	12A77	.65	25L6GT	.45
1H5GT	.38	6AH4	.67	6BH6	.45	6SC7	.59	12A06	.38	25W4GT	.45
1L4	.50	6AK5	.59	6BJ6	.41	6SD7GT	.39	12A07	.55	35A5	.49
1N5GT	.62	6AL5	.39	6BK7	.89	6SK7GT	.39	12AV6	.50	35B5	.38
1R5	.48	6AQ5	.39	6BL7GT	.65	6SL7GT	.49	12AV7	.60	35C5	.38
1S5	.40	6A06	.36	6BQ6GT	.77	6SN7GT	.55	12AX4GT	.55	35L6GT	.45
1T4	.48	6A07	.68	6BQ7A	.92	6SQ7GT	.37	12AX7	.55	35W4	.45
1U4	.48	6AR5	.45	6BZ7	.95	6T8	.75	12BA6	.40	35Z5GT	.45
1U5	.40	6AS5	.50	6C4	.39	6U7	.56	12BA7	.57	45	.53
1X2	.65	6AT6	.39	6CB6	.45	6U8	.59	12BE6	.41	50B5	.41
3A4	.45	6AU1GT	.70	6CD6G	1.15	6V6GT	.45	12BH7	.65	50C5	.41
3Q4	.48	6AU5	.82	6F6	.45	6W4GT	.45	12BY7	.65	50L6GT	.59
3Q5GT	.48	6AU6	.45	6H6	.53	6W6GT	.45	12BZ7	.65	70L7GT	1.07
3S4	.48	6AV6	.39	6J5	.40	6X4	.39	12SL7GT	.49	76	.42
3V4	.50	6AX4GT	.59	6J6	.50	6X5GT	.35	12SN7GT	.50	81	1.25
5U1G	.55	6BA6	.40	6K6GT	.39	7E6	.40	12SR7met.	.55	117L7GT	1.19
5Y3GT	.39	6BA7	.57	6L6	.62	7X6	.58	12V6GT	.50	117P7GT	1.39
5Y4G	.39	6BC5	.49	6R7	.49	7L7	.77	12X4	.35	117Z3	.39
6AB4	.42	6BD6	.45	6S4	.39	12AL5	.40	19BG6G	1.15	807	1.25
6AF4	.92	6BE6	.39	6S8GT	.51			19T8	.75		

T.V. PIX TUBES
BRIGHTENER \$1.39

PEE-WEE "HIDE-A-WAY" ANTENNA 79c
no bigger than a half dollar

HI-PO TV RECTIFIER TUBES LAST LONGER

Makes Picture brighter, larger
HI-PO 567 TO REPLACE \$1.39
HI-PO 6S78 TO REPLACE \$1.95
5U4G 6SN7GT

Free Five 1L4 tubes individually cartoned list value \$11.25 with every order of \$25.00 or more.
Many 7 volt types not listed. All tubes individually boxed. Orders under \$10 subject to \$1 handling charge. Tubes offered subject to prior sale. Prices subject to change. All orders shipped F.O.B. 25% deposit required on c.o.d. shipments.

SEND FOR FREE TUBE LISTING



NEW JERSEY TELEVISION SUPPLY CO.

Sole Distributor of NJRT Tubes

906A WESTFIELD AVE., ELIZABETH, N. J. EL. 3-6166

FREE!

ANY ONE OF THESE

HI-FIDELITY RECORDINGS

{50 to 15,000 Cycles}

BEETHOVEN

"Egmont" and "Coriolanus" Overtures

OR BIZET OR BACH

"Carmen" Suite



HERE is an amazing offer to lovers of fine music! Yours FREE—any one of these magnificent recordings—brilliantly performed by the celebrated Netherlands Philharmonic Orchestra, under the baton of the distinguished British conductor Walter Goehr. These recordings, pressed from the purest "Vinylite" Plastic, represent the last word in HIGH FIDELITY reproduction. Each has remarkable beauty of tone and virtual absence of surface noise. Yet you may have any one of them FREE! OR—you may have ALL THREE records for ONLY \$1.

We make this amazing offer to introduce you to the superb new Musical Masterpiece Society recordings. Each month you will receive notice of the two recordings selected by the Society. You may accept these records at our special price of LESS THAN ONE THIRD the usual retail price. Or you may reject any monthly selection either before or after you receive it.

There are no "strings" attached to this generous offer, and you are not obliged to buy any records at all! So rush coupon to: The Musical

Masterpiece Society, Inc., Dept. 527, 250 W. 57th St., New York 19, N. Y.

The Musical Masterpiece Society, Inc.
Dept. 527, 250 W. 57th St.
New York 19, N. Y.

Please send me the high-fidelity L. P. records checked.

BEETHOVEN BIZET BACH

NOTE: If you have checked ONE record, it is FREE—simply enclose 25c to help cover cost of special packing and shipping. If you have checked ALL THREE, enclose \$1. (WE pay postage.)

Please notify me each month of the Society's monthly selection of records which I may accept or reject. I am not obligated to purchase any records. And I may return any I do buy if not completely satisfied.

Name.....
Address.....
City.....Zone.....State.....

RADIO

CARD FILE

By H. JOHNSON

EVER wonder what to do with your spare time? Set up a card file indexing back issues of electronic periodicals on hand. You'll be able to locate diagrams and technical information easily and you will absorb plenty of technical information at the same time.

My card file uses 5 x 8 cards, listing some 12,000 items covering 4 periodicals over a period of approximately 6 years. It also includes several good text-books.



Fig. 1—Index tab shows subject head.

Setting up the card file in connection with Rider's manuals or some other indexed source of diagrams and technical data makes the job complete, since periodicals explain circuit operation and manuals supply circuit details. Circuits are usually explained in articles when they are first introduced, but several years may pass before you meet a particular circuit in a defective chassis. With an index it takes only a moment to find information needed for the job.

My file is set up in boxes 8 1/4 x 6 x 12 inches. It usually takes me about three hours a month to keep the file up to date.

The file system is interesting to review, watching the development of various circuits. It also saves considerable wear and tear on the library.

Set up subject heads on index tab cards. (Fig. 1.) Type the head on white paper and scotch-tape it to the index tab, using 3/4-inch tape. The tape keeps the tabs clean so they can be read easily.

Some of my headings are Alarms, Amateur, Amplifiers, Antennas, Attenuators, Coil Design, Converters, Electronic Control, Electronic Counting,

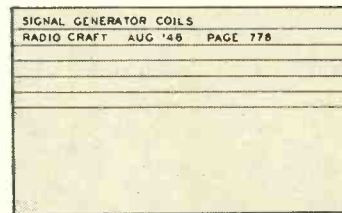
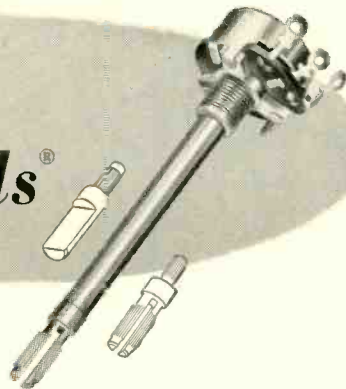

Fig. 2—File card contains references.

Mathematics, Microphone Circuits, Microwaves, Oscilloscopes, Oscillators, Phase Inverters, Test Equipment, along with others through the alphabet, totaling some 180 headings.

The general classification is listed on the tab card. The file card following is headed by the particular subject (E.g.

**Mallory
Midgetrols[®]**



Right for You and Your Customers

Because of excellent drift characteristics and extremely accurate taper curves, Mallory Midgetrols give your customers the set performance they want—long and trouble-free. Mallory Midgetrols are engineered for precision performance in both TV and radio sets despite variations in temperature and humidity.

Because of simplified design and construction, Mallory Midgetrols are easy to install quickly. Round, tubular shafts can be cut fast, accurately . . . are easily adapted for split-knurl, flatted, or set screw type knobs. And you can attach AC switches without control disassembly.

Because from every angle—quality, price, performance—Mallory Midgetrols are right for you . . . and your customers. Use them always.

Look at ALL 3 Features of this Mallory Control "Deal"

- (1) With the special Mallory Control Kit you get a selection of controls and switches that give coverage of more than 50 radio and TV set models.
 - (2) The Controls are selected on the basis of set popularity in your area.
 - (3) You get FREE a metal storage cabinet when you buy this deal.
- Ask your Mallory Distributor or write P. O. Box 1558, Indianapolis, Indiana.

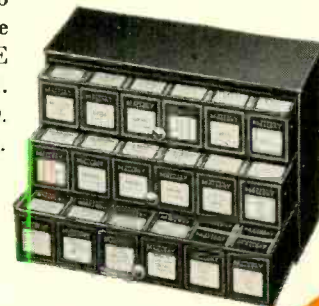

P. R. MALLORY & CO. Inc.
MALLORY

CAPACITORS • CONTROLS • VIBRATORS • SWITCHES • RESISTORS
RECTIFIERS • POWER SUPPLIES • CONVERTERS • MERCURY BATTERIES

APPROVED PRECISION PRODUCTS

P. R. MALLORY & CO. Inc., INDIANAPOLIS 6, INDIANA

3 NEW RIDER BOOKS FOR JULY

TV FIELD SERVICE MANUAL VOL. 2

1. Edited by Harold Alsberg

The finest practical data for in-the-home servicing. Tube layouts; picture tube adjustments; rear and front controls; tube compliment; tuner and horizontal oscillator adjustments; key voltages; tuner dial stringing; trouble symptoms; chart with tubes and parts to check; series filament wiring. Book lies flat, spiral binding. Covers 1947 through 1953. Volume 2 covers: Bendix, Capehart, CBS Columbia, Crosley, DuMont.

Approx. 160 (5 1/2" x 8 1/2") pages, illus. Soft cover.

Volume 1 (Issued in May) Covers: Admiral, Affiliated Retailers (Artone), Aimcee (AMC), Air King, Air Marshall, Allied Purchasing, Andrea, Arvin and Automatic.

128 (5 1/2" x 8 1/2") pages. Soft cover. Volume 1only \$2.10

2. HOW TO SERVICE TAPE RECORDERS

Everything you need to know about what is inside a tape recorder—operation of the recording head, types of electronic circuits, kinds of drive mechanisms used, trouble shooting—and how to service, the many types of tape recorders with practical examples. Also discusses requirements for a tape recorder repair shop. Soft cover.

SPECIALIZED AUTO RADIO MANUALS

Cover 5 years production (1950 thru 1954) of factory installed car radios. Identical data from other sources is just not available! Contains: Parts list, Schematics, Tube layout, Voltages, Trimmer location, Chassis Views, Chassis Pictures, Dial stringing and complete installation and removal information.

3. INDEPENDENT CAR MANUFACTURERS

Covers—Kaiser-Fraser, Henry-J, Studebaker, Nash, Hudson, Packard, Willys

VOL. 1-A (Released in May)
Ford . . . Lincoln . . . Mercury

VOL. 2-A (Release in June)
Buick . . . Cadillac . . . Oldsmobile

VOL. 3-A (Release in June)
Chevrolet, Pontiac, GMC Trucks, Chevrolet Trucks

Each Volume 8 1/2 x 11Soft Cover

WRITE FOR COMPLETE 32 PAGE NEW RIDER CATALOG

Buy these books now from your jobber, bookstore—if not available from these sources, write to:

JOHN F. RIDER PUBLISHER, INC.
480 Canal Street, New York 13, N. Y.

In Canada:
Mr. Charles W. Plinton
1828 Gerrard Street, East
Toronto, Ontario

Export Agent:
Roburo Agencies, Inc.
38 West 37th Street
New York 7, New York

West Coast Office:
4216 20th W. Jefferson Blvd.
Los Angeles, California

Cable Address:
Roburnza N. Y.

under coil design the file cards [Fig. 2] have headings such as R.F. Coils, Oscillator Coils, I.F. Coils, etc.) The magazine name, date, and page where the information appears are typed or printed clearly.

I find this a better plan than cutting out the diagrams and pasting them on file cards, since the complete article is always kept in good condition for further reference. END

CORRECTION

A table of dimensions for parts in Fig. 1 was inadvertently omitted from the article "R-J Type 12-inch Speaker Enclosure" in the May, 1954 issue. Fig. 1 is reprinted here with the table of dimensions.

TABLE

Code	Component	Dimensions (in inches)
A	Spacer	3/4 x 3/4 x 20
B	Speaker hole	10 1/2 inches Dia. in center of baffle
C	Speaker baffle	18 x 20 x 3/4
D	Spacer	3/4 x 3/4 x 20
E	Ozite strips	(see article)

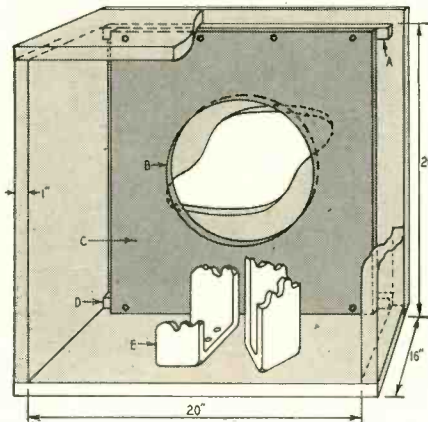

Radio Thirty-Five Years Ago In Gernsback Publications

HUGO GERNSBACK Founder

Modern Electrics	1908
Wireless Association of America	1908
Electrical Experimenter	1913
Radio News	1919
Science & Invention	1920
Television	1927
Radio-Craft	1929
Short-Wave Craft	1930
Television News	1931

Some of the larger libraries still have copies of ELECTRICAL EXPERIMENTER on file for interested readers.

In July, 1920, Electrical Experimenter (Science and Invention)

Do We "See" Electrically, by H. Winfield Secor

Listening for Signals from Mars, by Dr. Frederick H. Millener

A War-Time Radio Detective, by Pierre H. Boucheron

Marconi—The Master Radio Experimenter

Using Morse Relay for Code Practice, by Penuel E. Ballard

Transformer Using Spark Coil Parts, by E. W. Letper

Three Types of Amateur Spark Gaps, by Pierre H. Boucheron

RADELCO

LIGHTNING ARRESTOR FITS FLAT, OVAL, ROUND AND OPEN CABLES!

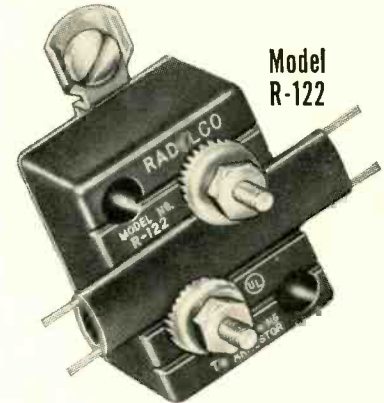

IT'S NEW! IT'S BETTER!

The only Underwriters Listed UHF-VHF Lightning Arrester selling at 90c list.

ORDER FROM
YOUR NEAREST
PARTS JOBBER

LIST PRICE

90¢

the sensational "QUICK-HOT" SOLDERING GUN

Built-In Spotlight

STEVE-EL "jumped the gun" by introducing the "QUICK-HOT" before anybody else. We have never been so excited about a soldering gun development as we are about "QUICK-HOT". It is without a doubt, the most efficient soldering gun of all 175 watt guns.

- ★ Extra long narrow tip for easy reach.
- ★ Built-in spotlight.
- ★ Lifetime tip.
- ★ Soldering heat in 2 1/2 seconds.

\$ 5.30
Only lots of 3
\$5.96 each

EXTRA SPECIAL
16 RP4
PICTURE TUBE
\$16.49
Brand new.
Guaranteed 1 year

FREE! Write Dept. RE-7 for
New BARGAIN BULLETIN

STEVE-EL Electronics Corp.
61 Reade St. New York 7, N. Y.

RADIO-ELECTRONICS

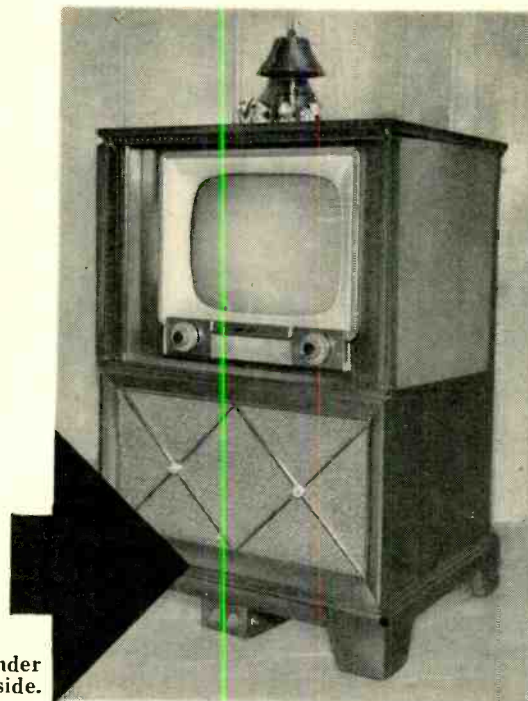

*A novel approach
for eliminating
the sponsor's message*

The killer in normal position under the TV set. Switch is on right side.

TRANSISTORIZED COMMERCIAL KILLER

By HAROLD REED

EXPERIMENTERS often use transistors in many applications, which although neither practical nor profitable on a commercial basis, prove interesting and satisfying to the hobbyist. These experimental applications contribute to familiarization and greater knowledge of transistor theory and circuitry. One such application is the transistorized commercial killer described in this article.

The unit is essentially a transistorized photoelectric relay that opens or short-circuits the voice-coil leads to the TV receiver's speaker. When the unit is connected and operating, I no longer have to get up and turn down the volume during commercials or when the phone rings. I simply turn on a small table lamp beside my favorite chair and the relay does the rest. I glance at the screen occasionally while the set is silenced to ascertain when the commercial is over.

The commercial killer can be used also with a radio receiver but the listener is at a disadvantage because he has no indication when the undesired part of the program has ended. In this application, however, the relay may be used to connect a resistor across the speaker voice coil to reduce the volume to a level where the program is barely audible when the table lamp is on.

This photoelectric relay (see Fig. 1) is built around the Raytheon CK722 p-n-p junction transistor connected in a grounded-emitter circuit. Two self-generating photocells are wired in series and connected between the base and emitter of the CK722. A sensitive relay is connected in the output, or collector circuit, along with a 50,000-ohm variable control for adjusting the negative voltage to the collector. All component parts are mounted in a 4 x 4 x 2-inch metal box with room to spare.

Construction

There is no critical arrangement in the mounting of the parts of the unit, except of course that the photocells be in proper position to allow light to strike the active surfaces. The relay, a surplus BK-7-B, has an adjustable slider and scale for adjusting its sensitivity. With the sliding arm at zero on the scale, the relay operates with a current flow of 100 μ a at 0.4 volt. The switch disconnects the battery and also prevents base-current flow which would occur when light strikes the active surface of the photocells.

The photocells are mounted on a strip of bakelite in which holes were cut, the exact diameter of the active portion of the cell surfaces. A larger cut, equivalent to the over-all diameter of the cell, is made halfway (counter-

sunk) through the back of the bakelite, allowing the cell to be recessed into the back of the strip. There is a small metallic ring deposit at the outer edge of the cell plate. I placed a strip of tinfoil under this ring and fastened it to a lug for the negative connection of the cell. Each plate and tinfoil is then held in place by the pressure from a spring leaf of a discarded phone jack or switch, which also provides contact with the back or positive connection of the cell, as shown in Fig. 2. Observe polarity and take care to prevent shorting between the tinfoil and positive coating on the back and edges of the plate.

After wiring the unit as in Fig. 1, experiment to obtain positive relay action when the control light source strikes the photocells. Several variable factors must be considered: the setting of the relay slider arm, the battery voltage applied through the variable control, the ambient room illumination, and the distance between the photo-relay and the table lamp.

The following operating characteristics were obtained with the unit described here: With a 25-watt lamp in the corner of the room 15 feet from the TV set (this lamp is normally turned on during a TV program), the collector voltage is adjusted to minus 12 and the relay sensitivity control

If you want professional sound quality



Sound engineers know that the selection of a fine amplifier, pickup and speaker system is only part of the story; that unless the turntable is of equal quality, music reproduction must suffer. That is why they insist on such high standards for turntable performance.

do as the professionals do...



Rek-O-Kut precision turntables are made to conform to the highest standards in the professional field, and they certainly represent the finest you can use in the home. A Rek-O-Kut turntable will make all the difference in the world. The finer your present system, the more apparent the improvement will be. Whether you select the deluxe T-12H or the standard LP-743, the entire performance of your sound system will become a new and thrilling experience.

use a REK-O-KUT precision turntable



Rek-O-Kut Precision Turntables are priced from \$59.50. Write for specifications and descriptive literature to Dept. J-13

The REK-O-KUT COMPANY

Manufacturers of Professional Disc Recorders and Specialized Sound Systems.

38-01 Queens Boulevard, Long Island City 3, New York
Export Division 458 Broadway, New York, U.S.A. Cables: Morhanex
In Canada: Atlas Radio Corp., Ltd., 560 King Street, W., Toronto 2B

OVER 50,000
TECHNICIANS
HAVE LEARNED

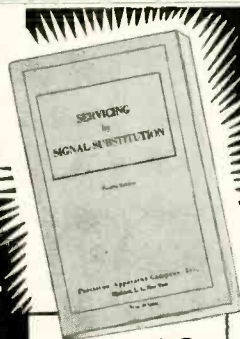

**'SERVICING BY
SIGNAL SUBSTITUTION'**
A BEST SELLER FOR OVER 12 YEARS!
(NEW, UP-TO-DATE, 12th EDITION)

HOW TO GET
THE MOST OUT
OF BASIC TEST
EQUIPMENT

for A.M. - F.M. - TV

ONLY **40¢**

103 pages. Invaluable information that will help you re-double the value of your basic test equipment.

The Modern, Simplified, Dynamic Approach to Receiver Adjustment & Alignment Problems.

- ★ Nothing complicated to learn
- ★ No extra equipment to purchase
- ★ Universal... non-obsolete
- ★ Employs only Basic Test Instruments

Ask for "S.S.S." at your local Radio Parts Jobber or remit 40¢ in small stamps or coin directly to factory.

PRECISION APPARATUS COMPANY, INC.
92-27 HORACE HARDING BLVD., ELMHURST 4, N. Y.

set to 13 on the scale. Collector current is $560 \mu\text{a}$ and the base current is $4 \mu\text{a}$. The relay is not energized.

The controlling light source is a table lamp with a 100-watt bulb, 10 feet from the TV set. When this lamp is on, the base current drops to $3 \mu\text{a}$ and the collector current increases to $575 \mu\text{a}$. This operates the relay and short-circuits or opens the speaker voice-coil leads. At 5 feet, the device can be operated with just one photo-cell. Also, using the two cells, a 75-watt lamp gives satisfactory operation at 5 feet. With less illumination and for

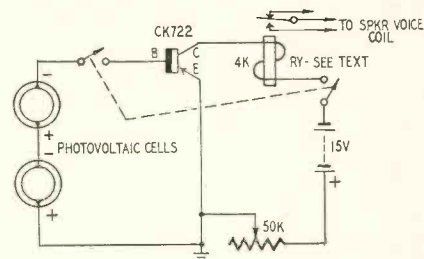

Fig. 1—The transistorized photoelectric relay used in commercial killer.

greater distances, more than 2 of these inexpensive cells could be used in series. Sensitivity could also be increased by using a larger photocell plate or Raytheon's CK721 transistor, which has a current amplification of

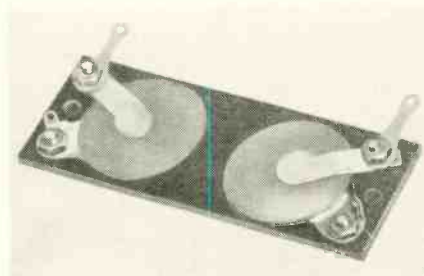

Fig. 2—Rear view of photocells counter-sunk into the bakelite mounting strip.

40. However, the cost will increase considerably.

A miniature radio tube could be made to function in this device, but the great advantage of the transistor in this application is its ability to operate without filament or plate voltages which would require a power supply

Parts for commercial killer

Miscellaneous: 1—CK722 transistor, 1—15-volt miniature battery (Eveready type 411 or equivalent), 1—50,000-ohm linear potentiometer, 1—d.p.s.t. toggle switch, 1—Cardwell BK-7-B relay, 2—photovoltaic cells (see text).

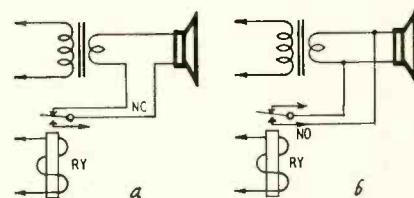

Fig. 3—Connections for opening voice coil at **a** or shorting it out as at **b**.



Photo of all parts used in the relay. The transistor, used in other experiments, is cemented to a small plastic block which supports its fragile leads.

or a means of obtaining these voltages from the TV chassis. The unit is small and completely self-contained, with just two wires to be attached to the TV speaker. Fig. 3 shows connections between the relay contacts and the speaker voice coil leads. The life of the small 15-volt battery in this circuit will probably be equivalent to its normal shelf life.

The cost of the unit is minimized by using surplus photocells and relay. I purchased the photocells for 29c each and the relay for \$1.95, from Burstein-Applebee Co., in Kansas City, Missouri. Olson Radio Warehouse, of Akron,

Ohio, has rectangular-shaped selenium cells which give the same output as the round ones used in this instrument. Advance type 850 or Potter and Brumfield series LS-5, 2,500-ohm relays can be used with a CK721 transistor. The components listed in the parts list are the least expensive.

While the immediate purpose of this unit is as a commercial killer, the basic circuit arrangement lends itself to many applications. Making use of the sensitive relay in the collector circuit, this unit can be used to energize or de-energize many types of electrical equipment. END

ELECTRICAL ENGINEERS *or* PHYSICS GRADUATES

with experience in
RADAR
or
ELECTRONICS
*or those desiring to enter
these areas...*

*The time was never
more opportune than
now for becoming
associated with the field
of advanced electronics.
Because of military
emphasis this is the most
rapidly growing and
promising sphere
of endeavor for the
young electrical
engineer or physicist.*

Since 1948 Hughes Research and Development Laboratories have been engaged in an expanding program for design, development and manufacture of highly complex radar fire control systems for fighter and interceptor aircraft. This requires Hughes technical advisors in the field to serve companies and military agencies employing the equipment.

As one of these field engineers you will become familiar with the entire systems involved, including the most advanced electronic computers. With this advantage you will be ideally situated to broaden your experience and learning more quickly for future application to advanced electronics activity.

Positions are available in the continental United States for married and single men under 35 years of age. Overseas assignments are open to single men only.

Scientific and Engineering Staff



RESEARCH AND
DEVELOPMENT
LABORATORIES

Culver City,
Los Angeles County,
California

Assurance is required that relocation of the applicant will not cause disruption of an urgent military project.



"His methods may seem a little crude, lady, but he often fixes them when I fail."

Mr. Serviceman
check these
items for...
Value!



See your local
Parts Jobber



Align-o-Pak

Model BE2

Eliminates TV Alignment Bias Batteries. Provides voltages recommended by all TV manufacturers. Quickly diagnoses AGC trouble.

\$7.85

UHF HI-PASS FILTER



Model HP2

Passes UHF, rejects VHF up to 50 DB without tuning. Eliminates FM, Airport, Taxi cab interference, etc.

\$2.37

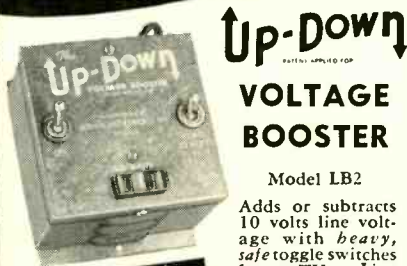

Up-Down

VOLTAGE BOOSTER

Model LB2

Adds or subtracts 10 volts line voltage with heavy, safetoggle switches for any TV set. Line restored to normal when turned off.

\$5.97

PEAK-TO-PEAK Comparison Meter



Add peak-to-peak measurements to your scope for only \$8.75 Handy for servicing gated AGC, gated sync separator, and essential for color. Write for Additional Information

SERVICE INSTRUMENTS CO.
422 So. Dearborn—Chicago 5

TECHNOTES

EICO 950-K R-C BRIDGE

Failure of the NE-51 neon lamp in the Eico 950-K R-C bridge to glow with 120 volts or less across it does not necessarily mean that it is bad. Short out the test terminals and set the voltage to maximum. Allow the bridge to run this way for 48 hours or so. This ages the lamp so it will light with a minimum of 65 volts specified in the operating instructions supplied with the bridge.

This aging process was used in the construction of two 950 kits. It saved the time and expense of purchasing a group of NE-51's and selecting a pair that worked properly.—G. P. Oberto

CROSLY 88T FM-AM SET

The set played normally on AM but was muffled and distorted when switched to FM. While checking voltages, I noticed that a section of the FM-AM switch was connected to the cathode of the 25L6-GT audio output tube. Inspection of the switch showed that when in the AM position the 20- μ f cathode bypass capacitor was disconnected from across the 150-ohm cathode resistor.

A check showed this capacitor to be partially shorted, thus causing distortion when it was switched into the circuit for FM reception. A replacement cleared the trouble.—J. E. Ryan

AIRCATTLE RECORD PLAYER

A Model WRA1-A Aircastle photo oscillator type record player had no output and its motor seemed to be burned out. When it was plugged into the line the motor would not run and the 6BA6 oscillator-modulator did not light.

Tackling the r.f. circuit first, I plugged in a new 6BA6. It lighted up and the motor began to run. This sudden starting of the motor stumped me until I checked the circuit and found that, in this model, the motor winding is connected in series with the heater of the 6BA6. Thus, the burned-out tube prevented the phono motor from running.—George R. Anglado

HALLICRAFTERS T-54, 505, 514

Poor horizontal and vertical sync on moderately strong stations may be caused by sync clipping due to insufficient a.g.c. on the r.f. circuits.

To remedy this, disconnect the 2.2-megohm resistor (R28 on the manufacturer's diagram, R12 in Photofacts) from ground. Wire the unused section (pins 3 and 4) of the 6H6 video detector

as a delayed a.g.c. rectifier as shown in the diagram. Disconnect the 560,000-ohm a.g.c. filter resistor (Hallcrafters R42, Photofacts R29) from Point A on the video detector load and connect it to B in the a.g.c. rectifier circuit.

Additional parts required are one each: 1,500-, 47,000-, and 100,000-ohm resistors and 330- μ f and .0015- μ f capacitors.

For further improvement, install 6BC5's or 6AG5's in the first and second video i.f. amplifiers. This increases the gain and results in less distortion of sync pulses. Do not change the last video i.f. stage because the circuit will oscillate. Realign the i.f. circuits after installing different tube types.—G. P. Oberto

ARVIN 9200 SERIES TV SETS

Complaints of sound distortion after warmup may be received on early production runs of the Arvin TE358 and TE363 receivers. This trouble is caused by a tendency for the quadrature coil L101 to drift off resonance.

This condition can be corrected by making minor alterations in the circuit to broaden the tuning of L101. Fig. 1 shows the physical arrangement of the components in early production sets and Fig. 2 shows the changes made in later runs to eliminate the trouble:

1. Remove C106 from terminal 4 of

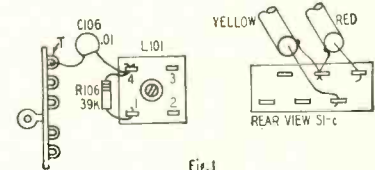

Fig. 1

L101 and terminal T on the terminal strip.

2. Remove the end of R106 from terminal 4 on L101 and connect it to T on the terminal strip.

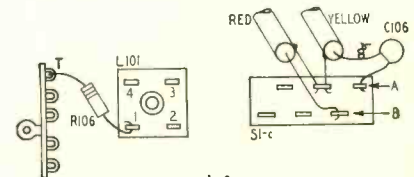
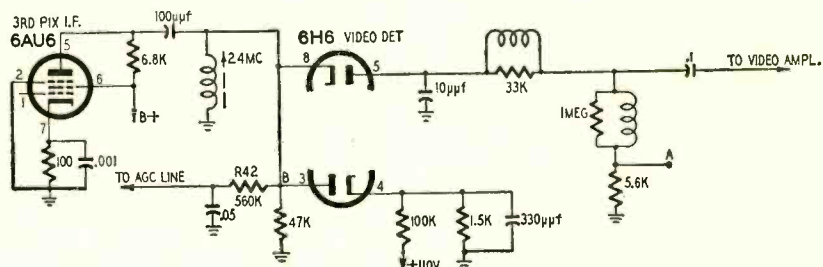

Fig. 2

3. Remove the center conductor of the yellow shielded wire from B on the PHONO-TV switch S1-c.

4. Move the center conductor of the red shielded lead from A to B on S1-c.

5. Add C106 from the center conductor of the yellow shielded lead to A on S1-c.—Arvin Service Bulletin



TELE-TONE MODEL 165

The complaint was distorted output with occasional intermittent operation.

The circuit of this set is rather unusual, especially in the method of obtaining bias for the audio output tube. The 50B5 output tube is biased by returning the ground end of its 330,000-ohm grid resistor to the oscillator grid of the 12BE6 converter tube. The bias voltage is developed by oscillator grid current flowing through the 18,000-ohm oscillator grid resistor. A check with a v.t.v.m. showed minus 7 volts on the oscillator grid and zero on the grid of the 50B5. The reason for the distortion was evident—no bias on the 50B5.

Although the .006- μ f audio coupling capacitor showed a d.c. resistance of well over 20 megohms, a normal bias appeared on the 50B5 grid when it was disconnected. This indicated that the capacitor was breaking down when a voltage was applied. The breakdown was intermittent and was sometimes severe enough to disable the oscillator and cause intermittent operation.

The trouble was eliminated by replacing the capacitor.—*H. M. Layden*

G-E 10T AND 12T SERIES TV SETS

Failure of the 4.5-mc i.f. transformers in humid areas has been traced to faulty lead dress which permits the secondary lead wires to touch the primary winding inside the shield can. Although the leads and windings are insulated, electrolysis occurs when humidity is high. This eventually causes a breakdown between the primary and secondary. To correct this trouble, place a fiber washer next to the primary to prevent the secondary leads from touching it.—*W. S. Ross*

PHILCO TYPE 91 R.F. CHASSIS

When the set is turned on cold, the screen of the picture tube is completely white without a sign of video modulation. The picture does not come in until after the set has been operating long enough to become completely warmed up. A check shows no video information on the grid of the first video amplifier tube. All resistors, capacitors, and peaking coils check O.K.

In several sets using the type 91 r.f. chassis this trouble was caused by an unsoldered connection on peaking coil L214. This was not noticeable because of the wax coating on the coil. The trouble can be cleared up by soldering the connection or replacing the coil.

When the set was cold, there was enough current through the unsoldered connection to check O.K. on the meter and to provide enough signal coupling to assure almost normal sound. After the set warmed up, the circuit was completed and the video circuit operated normally.

The defective part, L214, is a 10- μ h peaking coil with a d.c. resistance of 8 ohms located in the video detector output circuit at the junction of the 1N64 diode and the 5- μ f bypass capacitor.—*Paul Trinkle* END

there's an
extra profit
incentive
when you
sell
General
Instrument

GENERAL INSTRUMENT

all channel UHF converter

New exclusive features with sensational improved tuning element

GREATER PERFORMANCE, simpler construction, better design . . . these features place the new Model 66 General Instrument converter far out front as the favored unit with dealers, jobbers, service technicians. In UHF converters, the tuning element makes the difference . . . and General Instrument Corporation is a leader in the design and manufacture of UHF tuners! **JOBBERs:**—Some choice territories still remain open. Write for details about territories and extra profit

General Instrument & Appliance

CORPORATION

Subsidiary of GENERAL INSTRUMENT CORPORATION • 829 Newark Avenue • Elizabeth J. N. J.

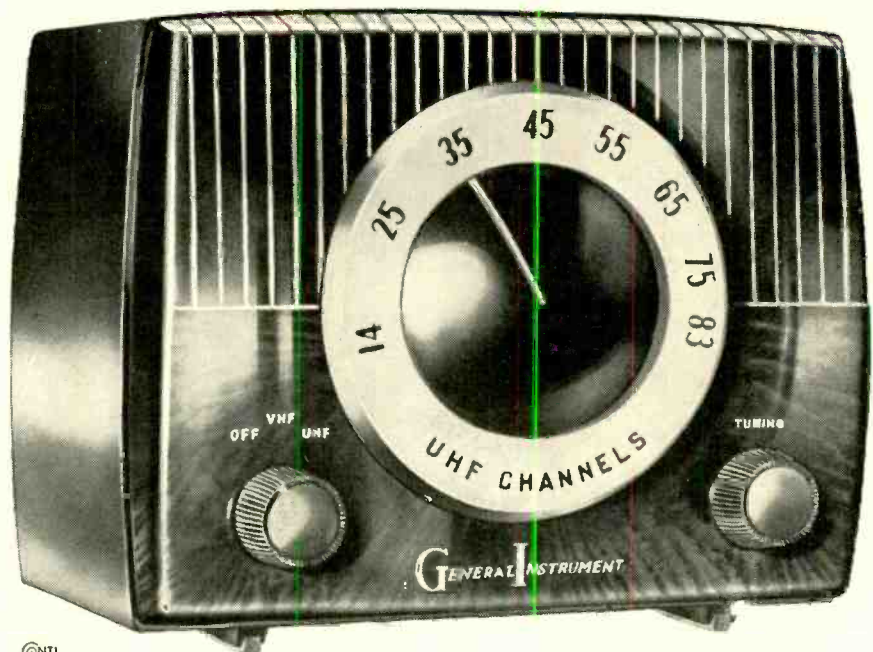

PHOTOGRAPHS

RADIO-ELECTRONICS can use good photographs of service benches, service shops, high-fidelity audio layouts, and any other interesting and original radio-electronic devices.

We will pay \$6.00 each for good professional photos or equivalent, suitable for reproduction.

Full information on subject photographed will increase their acceptability.

The Editor, RADIO-ELECTRONICS

25 West Broadway, New York 7, N. Y.

The NEW SUPER 60

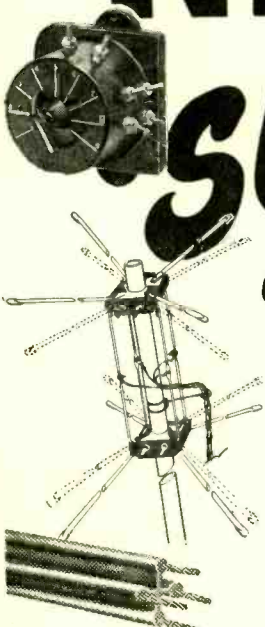

TV ANTENNA
UNCONDITIONALLY
GUARANTEED for
100 MILES ON VHF
60 MILES ON UHF
BOTH **COLOR AND BLACK & WHITE**
IN ALL DIRECTIONS ON ALL CHANNELS 2-83
WITHOUT A ROTOR MOTOR

LIST PRICE
\$36.75
SEE YOUR
JOBBER

ALL CHANNEL ANTENNA CORP.

47-39 49th STREET, WOODSIDE 77, N. Y.

EXETER 2-1336

THIS MONTH'S HERSEL SPECIALS

- RELAY BK-22K used with SCR 269F Direction Finder **\$3.95**
- RELAY 200 ohm S.P.S.T. Telephone type **.95**
- RELAY 5000 ohm D.P.S.T. Plate sensitive **1.95**
- RELAY 250 ohm Midget 4P.D.T. 24VDC **1.50**
- SWITCH High voltage IP.-6 position from BC-375 Trans. **.75**
- CHOKE 2.5 MH. 125 MA. **.35**
- VARIABLE CONDENSER APC, type 200mmfd. with can shield 1/4" shaft **.95**
- VARIABLE CONDENSER 150 mmfd. doubled spaced **.95**
- HEADSET HS-18 less head band. **.95**
- CHEST UNIT BE-74 Ideal for antenna installation crews, uses two 1 1/2 volt flash lite cells **1.95**
- RHEOSTAT 30 ohm 50 watts Ohmite Mfg. **.95**
- RHEOSTAT 30 ohm to 145 ohm 25 watts **.49**
- RESISTOR 1 Meg 1 watt 1 percent Precision Shallcross **.75**
- GLOW LAMP Argon 2 1/2 watt 105-125 volt med. base **.35**
- CORONA BALLS For tubes like VT-127A tubes doz. **1.00**
- PADDER Dual ceramic 3 to 12mmfd. Ideal for TV wave trap **.25**
- TRANSFORMER Scope Pri 110VAC Sec. 4000V at 10Ma **3.95**
- TRANSFORMER Modulation and Driver—815 Class AB2 output 56 watts Driver 6SN7 to modulator BOTH UNITS ONLY **4.95**
- TRANSFORMER RCA Output Push-Pull 6L6's 25 watts Pri. 5000 ohm

- output Sec. #1—500 ohms, Sec. #2—600 ohms sidetone 15 to 15,000 cy. flat HI-FI Special **1.95**
- DONUT ANTENNA Navy Type Ground Plane 144MC to 156MC **9.95**
- CHOKE Swinging 2 to 7 H 550MA. **5.95**
- MIKE Lip WE Navy Type #CW51071 **.95**
- TRANSFORMER Silver Slugged IF30MC **.95**
- TRANSFORMER IF T104 35-110MC. **.95**
- TRANSFORMER IF T109 5MC Disc. **.95**
- TRANSFORMER 1st Lim T107 5MC. **.95**

BUTTERFLY CONDENSERS:

- TYPE A 106-330 MC Antenna Type. **\$4.95**
- TYPE B 300-1000 MC—can use 368As tube **4.95**
- TYPE C 300-1000 MC—has clip for xial Det. **4.95**
- TYPE D 135-485 MC **4.95**

CONDENSER SPECIAL:

MFD	VOLT	PRICE
250	12	\$.39
500	10	.69
500	200	2.95
1000	3	.79
1000	15	1.29
2000	15	1.29
2000	50	2.95
32	450	1.29
16	600	1.75
1	1000 oil	.69
1	2000 oil	1.10
1	3000 oil	1.89
1	3600 oil	2.45
1	5000 oil	4.95
2	1000 oil	.75
3	660AC oil	2.65
PHOTO FLASH CONDENSER SPECIAL		
525	450	9.00

ATTENTION HAMS! NO MORE TVI Conversion data for DRAKE FISU low pass filter for 45MC cutoff frequency. **ALL BANDS** with conversion data **\$4.95**

TERMS: Cash with order or 25% DOWN — BALANCE C.O.D. NET 10 DAYS RATED ACCOUNTS ALL PRICES NET F.O.B. DETROIT
Merchandise Subject to Prior Sale
MIN. ORDER \$2.00

HERSEL RADIO CO.
5245 Grand River Ave.
DETROIT 8, MICHIGAN

Phone
TYler 8-9400

NEW DESIGN

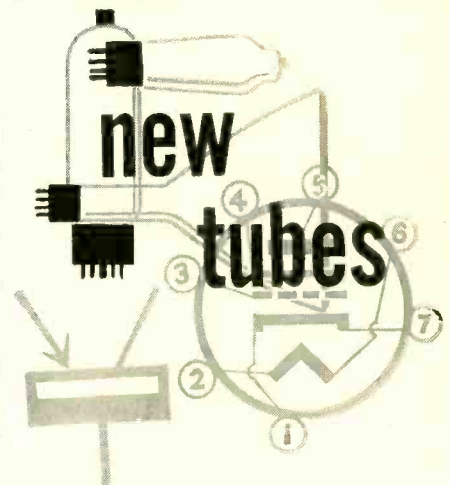

and Transistors

AFTER months of rapid-fire new-tube announcements, a lean month like this was bound to occur.

Refusing to be completely blacked out, RCA has announced the 6474/1854 image orthicon color TV camera tube. The 6474 is exceptionally sensitive and is capable of good resolution. Its spectral response approaches that of the eye. When using a suitably designed optical system and efficient color filters, the color camera can obtain commercially acceptable color pictures with about 350 foot-candles of incident incandescent illumination on the scene and a lens stop of f:5.6.

The photocathode used in the 6474 has a relatively wide spectral response with high blue and high green sensitivity, good red sensitivity, and practically no infrared sensitivity. The 6474 consists of an image section, a scanning section, and a multiplier section.

A medium-mu twin triode of the 9-pin miniature type, the 5965, has been announced by RCA for use in frequency-divider circuits in electronic computers and other on-off control equipment involving long periods of operation under cutoff conditions.

The 5965 maintains its emission capabilities even after long periods of cutoff, thereby providing plate-current consistency during its "on" cycles. Balance of cutoff bias between the two triodes is closely controlled during manufacture. The tube has a mid-tapped heater to permit operation from either a 6.3-volt or a 12.6-volt supply.

A rugged new hard-glass electron tube designed to withstand the high temperature and extreme stress conditions in military and commercial aircraft has been developed by Bendix Aviation Corp. The heat-resistant tube, with an envelope of Nonex glass, will operate at a bulb temperature of 572° F. for a minimum of 1,000 hours.

The high temperatures required to mold Nonex glass melted conventional lead-in wires before they could be sealed into the base of the tube. This made it necessary to use tungsten, with its high-temperature malleability, for these wires.

END



"...and all I did was install a
WALSCO antenna"

Buyers are getting wiser. The quality of *their* TV reception is *your* responsibility . . . and they'll hold you to it! For *your* protection, sell and install

WALSCO, the finest antennas ever built for VHF and UHF.

WALSCO IMPERIAL CONICAL (all-channel VHF)

Featuring the new, exclusive "Barrier Disc" Insulator to prevent shorts and maintain lasting high gain performance anywhere. Designed for color as well as black and white. Not affected by dirt, moisture, salt . . . will not rust. Stainless steel hardware prevents corrosion losses *permanently*. Pre-assembled . . . guaranteed 3 years!

Single Bay . . . only \$9.95 List. Also available in Dual and 4 Bay Stacks.

WALSCO CORNER REFLECTOR (UHF)

No other UHF antenna so effectively combines all three . . . (1) extra high gain; (2) all-channel reception; (3) sharp vertical and horizontal directivity. Features the hollow, unbreakable X-77 Insulator . . . silicone treated to shed dirt and moisture . . . not affected by extreme heat, cold or wind.

Single Bay . . . \$10.95 List. Also available in 2 and 4 Bay Stacks.

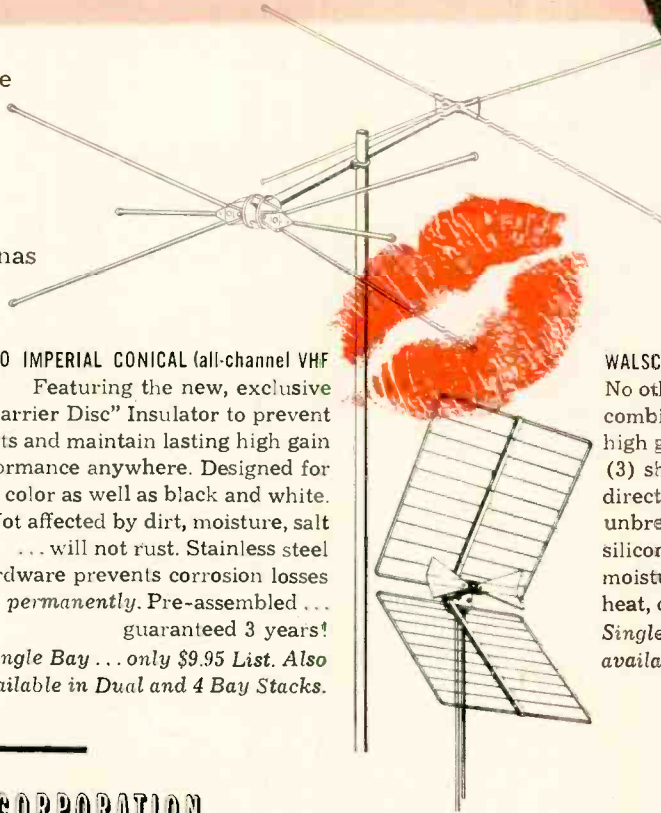

3602 Crenshaw Boulevard, Los Angeles 36, California

Overseas Distributor: Ad Auriema, Inc., 89 Broad St., New York 4, N.Y.

Branch: 315 West Walton, Chicago, Illinois

Canadian Factory Distributor: Atlas Radio Corp., Ltd., 560 King St. West, Toronto 2-B.

AMPHENOL

BPQ*

antennas & accessories...

Better Picture Quality—the acid test of every antenna and installation accessory. That is why the complete AMPHENOL quality installation is the first choice of dealers, servicemen and the viewing public—for with AMPHENOL, BPQ is assured.

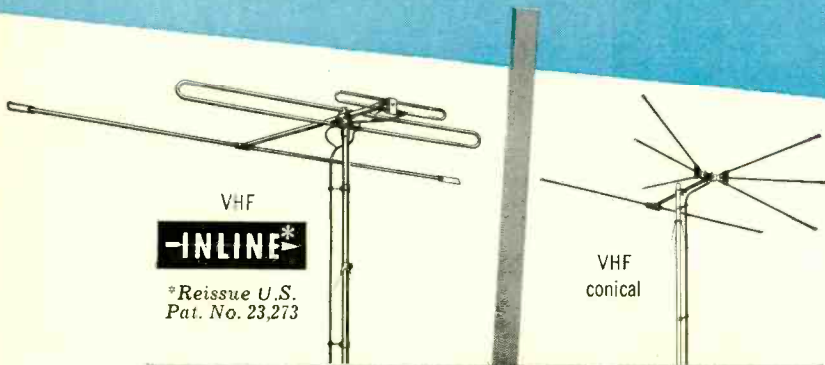

VHF
-INLINE*

*Reissue U.S.
Pat. No. 23,273



VHF
conical

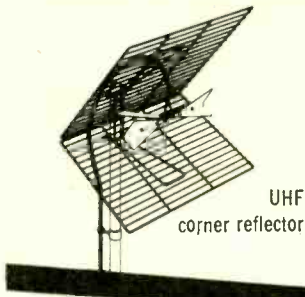

UHF
corner reflector

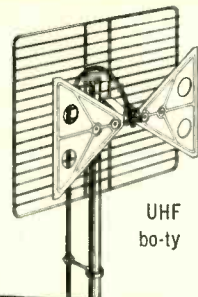

UHF
bo-ty

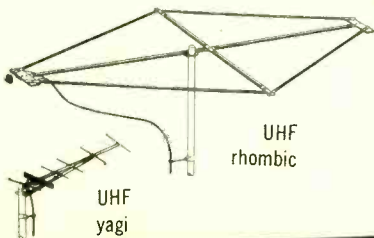

UHF
rhombic

UHF
yagi

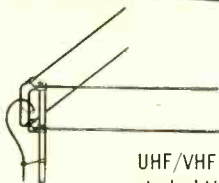

UHF/VHF
stacked-V

stand-off insulators



AIR-CORE tubular Twin-Lead*
*U. S. Pat. No. 2,543,696



famed Flat Twin-Lead

new TELE-COUPLER

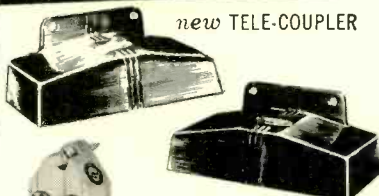

new TRISONET

new LIGHTNING ARRESTOR



WITH THE TECHNICIAN

MARTS JOINS NATESA

A special bulletin of the Milwaukee Association of Radio and Television Services (MARTS) reported that the officers of that association, after an all-day session at the headquarters of NATESA in Chicago, had decided to join NATESA, subject to ratification by the membership at the next business meeting.

The rest of the bulletin was devoted to news briefs and an item about Frank Moch, president of NATESA, who was to address the next membership meeting. The item—which served to introduce NATESA as well as Frank Moch—was largely composed of selected quotations from his speeches and writings. The back page of the bulletin contained a convenient membership application.

ETHICAL FREE SERVICE

The Television Installation Service Association (TISA) of Chicago has offered free TV service to institutions open to orphans, cripples, and the aged, as well as to organizations which operate "off the street" centers for children and adolescents. The only stipulation is that the organization or institution be one which makes no charge to the recipient of its benefits. Organizations are asked to apply to TISA on their letterheads, giving make, model, and serial number of the set on which service is desired.

TISA has also formed a lecture bureau to supply speakers to meetings of nontechnical TV users who would like to hear about color, or are willing to be informed about the problems of TV reception and TV servicing. The lecturers are prepared to address civic, religious, fraternal, or PTA groups, giving the answers to such questions as: How often does a TV set need servicing? What can go wrong? How much should it cost? How long should a picture tube last? What will it cost to maintain a color TV set?

ARTSD GETS TV ADS

A recent report from the Associated Radio-Television Service Dealers of Columbus, Ohio, indicates that the membership is enjoying the results of TV advertising. Fred Colton of the ARTSD Publicity Committee—the report states—explained to the members the fine co-operation the association was receiving from WTVN through spot announcements and displaying the ARTSD emblem. Members were asked to call customers' attention to the excellent programs on channel 6 (where they might see the association publicity).

NEVER UNDERESTIMATE . . .

Wives were the principal subject of discussion at the San Antonio Radio and Television Association's April meeting. It was especially felt that the wives would benefit greatly from the

AMERICAN PHENOLIC CORPORATION
chicago 50, illinois

AMPHENOL

Giving coils a high IQ*



**DELCO RADIO CAREFULLY CONTROLS THE PRODUCTION
OF ORIGINAL AND REPLACEMENT RF AND IF COILS**



Each RF and IF coil is wound under the supervision of a skilled operator, and each is tested at several points along the production line. This painstaking care is what gives a high IQ to Delco Radio Coils.



A GENERAL MOTORS PRODUCT  A UNITED MOTORS LINE

*INBUILT QUALITY. The "Q" of a coil affects its performance in the circuit, and is of vital importance to the radio engineer. The "IQ" of all RF and IF coils used for servicing is of equal importance to you, and can mean real customer satisfaction. To assure high IQ, Delco Radio carefully controls the production of all RF and IF coils—both original equipment and replacement coils.

If you could visit the Delco Radio plant, you would see skilled operators sitting at expensive specially designed machines winding high-quality coils. On the production line, these coils are assembled with their powdered iron cores and shield cans. By controlling all steps of the production, Delco Radio gives its coils not only the required Q, but also the highest possible IQ—*Inbuilt Quality*. Delco Radio parts are available through your UMS Delco Electronics Distributor.

DISTRIBUTED BY ELECTRONICS WHOLESALERS EVERYWHERE

DELCO RADIO

DIVISION OF GENERAL MOTORS CORPORATION, KOKOMO, INDIANA

NEW DEVICES

DOT GENERATORS

Sylvania Electric Products, Inc., 1740 Broadway, New York 19, N. Y., announced that they have developed and begun production of color television dot generators.

The color dot generator introduces on the color screen a large number of rectangles of light, which are large enough to show exactly the degree to which the electron beams are out of proper convergence. By observing these rectangles while the tube is being adjusted externally, the service technician is able to determine when the beams converge at the aperture.

The device is expected to have wide application in color television laboratories and plants.



TRIAxIAL SPEAKERS

Electro-Voice, Inc., Buchanan, Mich., has announced the new 12- and 15-inch triaxial 3-way speaker. The units combine the Super Sonax high-frequency driver with the Radax treble propagator and bass cone to cover a range of 30 to 15,000 cycles in E-V Regency or Aristocrat enclosures. The assemblies include an X-36 m-derived crossover network and an AT-37 brilliance control for adjusting the tweeter volume level.

The model 12TRX is 12½ inches in diameter and 8 inches deep, and has a 3.5-pound magnet. The 15TRX is 15½

inches in diameter and 9¾ inches deep, with a 5.75-pound magnet. Both units have 16-ohm input impedances.

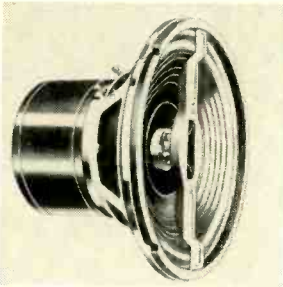

TV ANTENNA

Radiart Corporation, 3455 Vega Ave., Cleveland, Ohio, has announced the development of an all-channel television antenna called the *Ultamatic*. It is perfectly synchronized for both monochromatic and color reception and has a gain response that does not vary more than 3 db on any channel across the band.

Other features of the *Ultamatic* include a high front-to-back ratio, heavy-gauge dipole and boom assembly and easily assembled reflector.

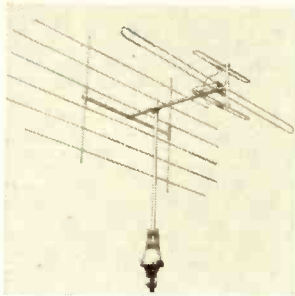

TUBE TESTER

Electronic Measurements Corp., 280 Lafayette Street, New York 12, N. Y., has announced the production of a precision tube tester, model 208.

It checks all octal, miniature and noval base tubes for tube quality as well as shorts, leakages, continuity, or opens between any two elements of the tube.

A flexible switching system assures complete tube testing of present and future tubes. A visual line voltage check is incorporated.

Individual sockets are furnished for each tube type to eliminate possible prong damage. To further lessen the chance of prong damage all elements are numbered according to pin number in RETMA base numbering systems.



TRANSISTOR KIT

Precise Development Corp., Ocean-side, L. I., N. Y., has announced the model T1 transistor kit which includes all equipment (transistors, transformers, coils, etc.) necessary to permit one to acquire basic transistor knowledge through actual experimental and practical use of audio one-stage amplifiers through transformer-coupled amplifiers and special circuits.

A simple instruction book covers the physics of transistors and shows the application.

HIGH-VOLTAGE PROBE

EICO (Electronic Instrument Co., Inc., 84 Withers Street, Brooklyn, N. Y.), has announced production of the new model HVP-2 high-voltage probe. Designed for use with any v.t.v.m. or



20,000-ohms per volt multimeters, it permits measurements up to 30,000 volts for TV servicing purposes.

A smooth body prevents dangerous accumulations of dirt or moisture; two large flash-guards lengthen the leakage path; the multiplier resistor is completely encased within the probe body; the fully insulated grip prevents any metal touching the hand; the probe tip is of anticorona construction, and a high-voltage cable is covered with special protective insulation. These six features add up to complete safety.

LIGHTNING ARRESTOR

American Phenolic Corp., 1830 South 54 Avenue, Chicago, Ill., is now producing a new lightning arrester for u.h.f. and v.h.f. reception. It protects the TV set and dwelling from the hazards of lightning and also guards the signal from the antenna as well. It gives complete protection in both the u.h.f. and v.h.f. bands, plus the lowest possible measurable loss in signal strength. It handles flat, tubular, or open-wire transmission line.



IDEAS that will help you to
MOVE AHEAD
and **MAKE MORE MONEY** in

RADIO - ELECTRONICS

A FEW OF THE FEATURES you won't want to miss in next month's issue and the issues ahead:

• **HORIZONTAL INSTABILITY**
A discussion of this important subject in service technician's language.

• **TV ANTENNA REPAIRS**
A report of the methods used by a successful service organization.

• **HOW TO MATCH SPEAKERS**
A discussion of the constant-voltage line for Audio and High Fidelity.

• **TV COLOR CIRCUITS**
A new installment of this continuing, important series every service technician needs.

• **HIGH-QUALITY AUDIO**
The 12th in the series covering this field.

• **SERVICING HIGH-FIDELITY EQUIPMENT**
Another installment of this practical, down-to-earth series.

• **LOW COST DOMESTIC AMPLIFIER**
Good quality at a very low cost.

• **PRINTED RADIO CIRCUITS AND HIGH-FIDELITY FM TUNERS**
Interesting features of a new FM tuner.

• **TRANSISTOR COMMERCIAL CUTTER**
How to stop commercials with a flashlight.

• **JUNCTION TRANSISTOR CHECKER**
An instrument which provides a reliable method for learning the condition of your transistor.

• **HIGH ACCURACY OHMMETER CIRCUITS**
Ways of reading your Ohmmeter closer.

● FREE! VALUABLE COLOR TV SERVICING GUIDE

... yours as a gift with your subscription to RADIO-ELECTRONICS if you send payment NOW!



YOUR NO RISK GUARANTEE

If at any time you do not feel that RADIO-ELECTRONICS is a real help to you, just tell us so and we will promptly refund the unused portion of your subscription. You may keep the TV service guide as a gift. Fair enough? We want you to be the sole judge.

DON'T MISS A SINGLE ISSUE—subscribe today and SAVE MONEY!
JUST GIVE THIS COUPON to your magazine agent or mail it direct to us. →

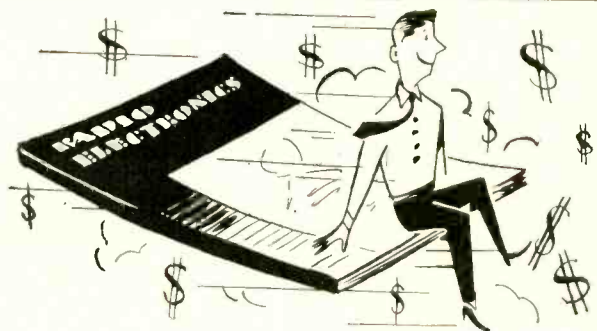

YES—I want to MOVE AHEAD AND MAKE MORE MONEY

Please enter my subscription to RADIO-ELECTRONICS as checked below under your NO RISK offer and send me as a free gift the COLOR TV SERVICING GUIDE.

PLEASE CHECK:

- One Year—12 big issues—\$3.50
(SAVING ME 85c over the single copy price)
Or you may prefer:
 3 Years—36 big issues—\$8.00
(SAVING ME \$5.05 over the single copy price)
 2 Years—24 big issues—\$6.00
(SAVING ME \$2.70 over the single copy price)
 I enclose \$..... Please bill me.

NAME _____ (Please Print Clearly)

ADDRESS _____

CITY _____ ZONE _____ STATE _____ 74

MAIL TODAY TO: RADIO-ELECTRONICS
25 West Broadway, New York 7, N.Y.

SPEAKER KITS

Oxford Electric Corp., 3911 South Michigan Ave., Chicago, Ill., is introducing to the trade a new line of rear-deck speaker kits. The model employs the ever popular 6 x 9-inch elliptical speaker, and the model RD-57 has a 5 x 7-inch elliptical speaker. The RD-57 unit was selected as the second model, since a number of late model cars are equipped with cutouts for this size unit. Both speakers have 2.15-ounce Alnico V magnets and 3/4-inch voice coils, which means there is sufficient power-handling capacity for the most powerful car radios.

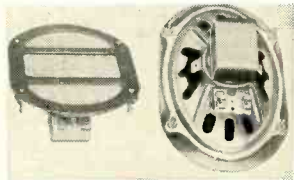

The kits are complete with all necessary hardware and grille plates and are boxed in a display type carton.

CELLULINE LEAD-IN

Belden Manufacturing Co., 4647 W. Van Buren Street, Chicago, Ill., has announced a new 300-ohm u.h.f.-v.h.f. lead-in that employs a moistureproof cellular polyethylene core to eliminate moisture and maintain constant characteristics. It is water-, sun-, wind-, and abrasion-resistant. No end seal is required, and conductor spacing is constant at all times. It has a core made up of thousands of separately sealed tiny cells filled with inert gas.



The conductors are embedded in the heavy outer wall of brown virgin polyethylene. This wall protects the cable against mechanical abuse and damage from ultraviolet sunrays.

NEW HEADPHONE UNIT

Telex, Inc., Telex Park, St. Paul, Minn., has developed a high-fidelity and lightweight headphone unit called the Dynaset.

The unit weighs only 1.25 ounces and is equipped with a high-fidelity speaker which is 3/4 inch in diameter.

It can be used with transcription machines, for radio monitoring, and many other hearing applications. It is made of tough, sturdy Tenite and has exchangeable ear tips, anodized aluminum tone arms, and flexible tubing.

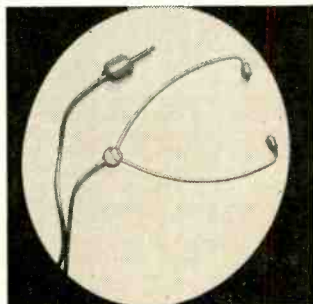

The high-fidelity range covers both speech and music. Its under-the-chin styling makes it suitable for use by women, eliminating hair muss and head-band fatigue. Its sensitivity is 105 db above .000204 dynes per square centimeter for 1 milliwatt power input, and the frequency range is from 50 to 8,000 cycles or better.

HI-FI AUDIO AMPLIFIER

Regency Division, I.D.E.A., 7900 Pendleton Pike, Indianapolis 26, Ind., has introduced a new high-fidelity audio amplifier, model HF-150, with a pre-amplifier and power supply.

A wide range of reproduction is obtained through five controls: bass, treble, loudness, level control and

record compensation, and input selector. The model HF-150 has a rated output of 12 watts and a frequency response of 20 to 40,000 cycles within 1/2 db.



ACOUSTIC-GRILLE

Walsco Electronics Corporation, 3602 Crenshaw Blvd., Los Angeles, Calif., has put out a new speaker grille called the *Acousto-Grille* which has specially perforated fiber that needs no grille cloth backing. It has a gold finish and may be painted any color.

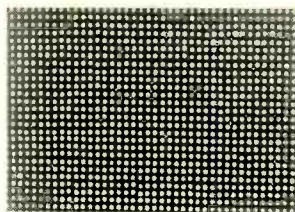

FILTER NETWORK

Cornell-Dubilier Electric Corp., 333 Hamilton Blvd., South Plainfield, N. J., has announced a new filter network, the model UAK-4, for television antenna installations. It is designed with coils and capacitors, but contains no resistors. Therefore, it functions as a low-loss filter. Other features include: sealed polystyrene case with molded standoffs; maximum signal rejection ratio insuring minimum signal interaction; easy installation; positive gripping to fit almost any mast; use in nominal 300-ohm installations; no ghosts or images because there is minimum reflection loss. It is intended for segregating v.h.f. and u.h.f. at the set and is guaranteed to work with u.h.f.

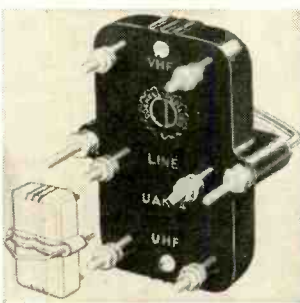

SPEAKER ENCLOSURES

Lowell Manufacturing Co., 3030 Lacade Station Road, St. Louis 17, Mo., has announced the introduction of its new 1954 speaker enclosures.

In the larger speaker enclosures resonance is prevented by heavy under-coatings. Many models are available with adjustable plaster flanges. Three-quarter-inch knockouts provide for PA and intercom wall and ceiling installation. Speaker boxes are constructed of 18-gauge steel and speakers from 4 to 9 inches can be placed in them.

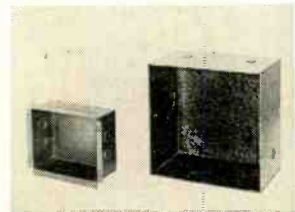

BUILD 15 RADIOS

ONLY

AT HOME \$19⁹⁵

With the New Improved 1954

Progressive Radio "EDU-KIT"

NOW INCLUDES
SIGNAL TRACER
and
CODE OSCILLATOR

- ATTRACTIVELY GIFT PACKED
- FREE SOLDERING IRON
- NO ADDITIONAL PARTS NEEDED
- EXCELLENT BACKGROUND FOR TV
- 10 DAY MONEY-BACK GUARANTEE
- SCHOOL INQUIRIES INVITED
- ABSOLUTELY NO KNOWLEDGE OF RADIO NECESSARY



WHAT THE PROGRESSIVE RADIO "EDU-KIT" OFFERS YOU

The Progressive Radio "Edu-Kit" offers you a home study course at a rock bottom price. Our Kit is designed to train Radio Technicians, with the basic facts of Radio Theory and Construction Practice expressed simply and clearly. You will gain a knowledge of basic Radio Principles involved in Radio Reception, Radio Transmission and Audio Amplification.

You will learn how to identify Radio Symbols and Diagrams; how to build radios, using regular radio circuit schematics; how to mount various radio parts; how to wire and solder in a professional manner. You will learn how to operate Receivers, Transmitters, and Audio Amplifiers. You will learn how to service and trouble-shoot radios. You will learn code. You will receive training for F.C.C. license.

In brief, you will receive a practical basic education in Radio, worth many times the small price you pay.

THE KIT FOR EVERYONE

The Progressive Radio "Edu-Kit" was specifically prepared for any person who has a desire to learn Radio. The Kit has been used successfully by young and old in all parts of the world. It is not necessary that you have even the slightest background in science or radio.

The Progressive Radio "Edu-Kit" is used by many Radio Schools and Clubs in this country and abroad. It is used for training and rehabilitation of Armed Forces Personnel and Veterans throughout the world.

The Progressive Radio "Edu-Kit" requires no instructor. All instructions are included. All parts are individually boxed, and identified by name, photograph and diagram. Every step involved in building these sets is carefully explained. You cannot make a mistake.

PROGRESSIVE TEACHING METHOD

The Progressive Radio "Edu-Kit" comes complete with instructions. These instructions are arranged in a clear, simple and progressive manner. The theory of Radio Transmission, Radio Reception, Audio Amplification and servicing by Signal Tracing is clearly explained. Every part is identified by photograph and diagram. You will learn the function and theory of every part used.

The Progressive Radio "Edu-Kit" uses the principle of "Learn by Doing". Therefore you will build radios, perform jobs, and conduct experiments to illustrate the principles which you learn. These radios are designed in a modern manner, according to the best principles of present-day educational practice. You begin by building a simple radio. The next set that you build is slightly more advanced. Gradually, in a progressive manner, you will find yourself constructing still more advanced multi-tube radio sets, and doing work like a professional Radio Technician. Altogether you will build fifteen radios, including Receivers, Transmitters, Amplifiers, Code Oscillator and Signal Tracer. These sets operate on 105-125 V. AC/DC. An Adaptor for 210-250 V. AC/DC operation is available.

THE PROGRESSIVE RADIO "EDU-KIT" IS COMPLETE

You will receive every part necessary to build 15 different radio sets. Our kits contain tubes, tube sockets, chassis, variable condensers, electrolytic condensers, mica condensers, paper condensers, resistors, line cords, selenium rectifiers, pie strips, coils, hardware, tubing, etc.

Every part that you need is included. These parts are individually packaged, so that you can easily identify every item. A soldering iron is included, as well as an Electrical and Radio Tester. Complete, easy-to-follow instructions are provided.

In addition, the "Edu-Kit" now contains lessons for servicing with the Progressive Signal Tracer, F.C.C. instructions, quizzes. The "Edu-Kit" is a complete radio course, down to the smallest detail.

TROUBLE-SHOOTING LESSONS

Trouble-shooting and servicing are included. You will be taught to recognize and repair troubles. You will build and learn to operate a professional Signal Tracer. You receive an Electrical and Radio Tester, and learn to use it for radio repairs. While you are learning in this practical way, you will be able to do many a repair job for your neighbors and friends, and charge fees which will far exceed the cost of the "Edu-Kit". Here is your opportunity to learn radio quickly and easily, and have others pay for it. Our Consultation Service will help you with any technical problems which you may have.

FREE EXTRAS

- ELECTRICAL & RADIO TESTER ● ELECTRIC SOLDERING IRON ● TV BOOK ● RADIO TROUBLE-SHOOTING GUIDE ● CONSULTATION SERVICE ● QUIZZES ● F.C.C. TRAINING
- Progressive "Edu-Kits" Inc., 497 Union Ave., Dept. RE-85, Brooklyn 11, N.Y.

MAIL TODAY—Order shipped same day received.

10-Day Money-Back Guarantee. Include ALL FREE EXTRAS

- Send "Edu-Kit" Postpaid. I enclose full payment of \$19.95 (U.S.A. only).
- Send "Edu-Kit" Postpaid. I enclose full payment of \$20.95 (Outside U.S.A.).
- Send "Edu-Kit" C.O.D. I will pay \$19.95 plus postage (U.S.A. only).
- I wish additional information describing "Edu-Kit". No Obligation.
- Send me FREE Radio-TV Servicing Literature. No Obligation.

Name.....
Address.....

PROGRESSIVE "EDU-KITS" INC.

497 UNION AVE., Dept. RE-85, Brooklyn 11, N. Y.

MATCHED DIODES

Radio Receptor Co., Inc., Seletron and Germanium Div., 251 West 19 St., New York 11, N. Y., is now supplying Type IN35, a matched pair of diodes, mounted in a single bracket. This improvement supersedes the common type of double bracket mount which is more difficult and costly to handle, and at the same time apt to cause undue strain on the diodes.

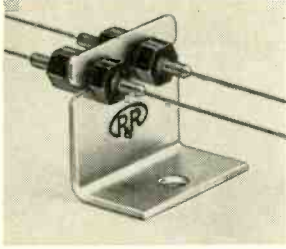

Uses for the IN35 are in FM discriminators, ratio detectors, phase detectors, industrial control circuits, and other applications requiring matched pairs of diodes.

TUBULAR CERAMICONS

Erie Resistor Corp., Distributor Div., Erie, Pa., has put on the market a complete new line of temperature compensating ceramicons covering a wide range of capacity values in three temperature coefficients: NPO, N330, and N750. Close tolerance capacitance and temperature coefficient units in non-insulated, molded insulated, and dipped phenolic insulated styles provide commercial equivalents of many often used JAN types.

One purpose of the three temperature coefficients is to provide the means of combining in parallel, various combinations of NPO and N330; and NPO and N750 to obtain intermediate temperature coefficients.

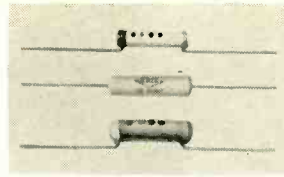

LAPEL MICROPHONE

The Turner Co., 933 17 Street N. E., Cedar Rapids, Iowa, is now marketing the new improved lapel microphone L-100.

The new crystal microphone weighs only one ounce without the cable. An exclusive adjustable, rubber-padded clip permits the microphone to be clipped anywhere, and the cord is always straight down while the microphone is in the upright position.

The frequency response is 50 to 10,000 c.p.s.; the output level, 52 db

below 1-volt/dyne/sq. cm; the pick-up pattern is essentially non-directional. It is furnished with 20-foot attached single-conductor shielded cable.

The microphone is sold without the clip as the Model 100. The specifications are the same, with the exception of the cable which is a 7-foot attached single-conductor shielded cable.

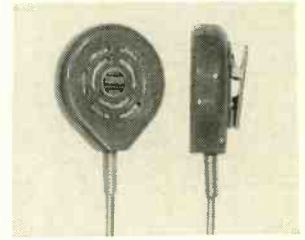

THE #630 TV RECEIVER

remains unmatched for quality and performance • • • RCA designed and developed this set quality-wise *not* price-wise • • • The original 10" set retailed at \$375.00 • • • Subsequent TV sets serve to prove the sacrifice of quality for price • • • what better proof can there be of its superiority than the fact that it is the choice of TV engineers and TV technicians! Herewith we offer you—YOUR BEST BUYS IN TV!—All you pay is the price shown • • • Excise taxes have already been paid by us.

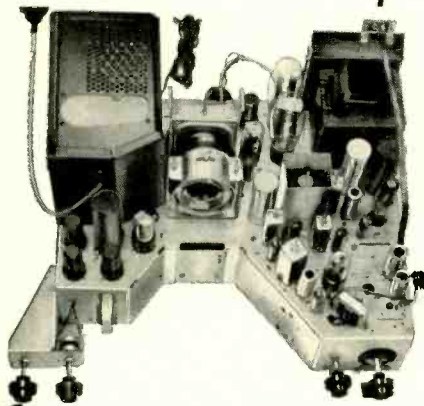

Build your own

SUPER DELUXE

31-TUBE

#630 TV CHASSIS

With—U. H. F.

With a #630 SUPER DELUXE 31-TUBE TV KIT including your favorite U.H.F. Station. Engineered in strict adherence to the genuine RCA #630 plus added features . . . OPERATES 16" to 24" PICTURE TUBES . . . FULL 4 MC BANDWIDTH . . . CASCADE TUNER . . . COSINE DEFLECTION YOKE . . . LARGER POWER TRANSFORMER . . . KEYED AGC . . . 12" SPEAKER . . . UNIVERSAL MOUNTING BRACKETS . . . CONDENSERS and RESISTORS at rated capacities and tolerances. You receive a COMPLETE SET of PARTS and TUBES, everything needed is included (less wire & solder). All I.F. Coils and Transformers are factory pre-aligned and tuned. You will enjoy building it with "LIFESIZE easy to follow step-by-step ASSEMBLING INSTRUCTIONS" included with each KIT.

NOTHING BETTER AT ANY PRICE!

only . . . \$119.44 (less C.R.T.)

DUMONT OR SHELDON PICTURE TUBES

MOST desirable 4 sizes . . . BRAND NEW in Factory Sealed Cartons—With a Full Year Guarantee

17" #17BP4A \$29.63 21" #21EP4A \$44.68 24" #24CP4A \$58.26 27" #27NP4A \$82.57
Aluminized Aluminized Aluminized Aluminized

MANHATTAN CONSOLE TV CABINET, C.R.T. size 17" to 21" . . . \$59.37

VOGUE TABLE MODEL TV CABINET, C.R.T. size 17" to 21" . . . \$39.89

Either in genuine mahogany or walnut (blond 10% extra) supplied with everything needed complete, drilled to fit #630 Chassis or blank panel for any TV Chassis.

BROOKS RADIO & TV CORP., 84 Vesey St., Dept. A. New York 7, N.Y.

TELEPHONE
COrtland 7-2359

#630

Super Deluxe TV Chassis

with U.H.F. —Licensed under RCA patents
COMPLETE READY TO PLUG IN AND PLAY—
Similar in characteristics and features to the TV KIT at left • Manufactured especially for us by Regal Electronics Corporation • No efforts or expense have been spared in workmanship or materials, to make this #630 SUPER DELUXE TV CHASSIS the Best obtainable for fringe areas, clarity and all-around-performance, regardless of price. Customers report reception better than 200 miles • Each Set is factory aligned and air-tested • All parts carry the RMA three month guarantee • Our mass volume of business on this CHASSIS (numbering thousands of pleased customers) now makes it possible for us to reduce the price to **\$157.97** only (less CRT)

#630

SPECIALS BY TECH-MASTER

27" GOLD MEDAL 2430-9 TV CHASSIS

Including your assigned U.H.F. Station

90° deflection, operates all 24" or 27" rectangular and 30" round picture tubes. The last word in TV achievement • Ideal for wall or custom-cabinet mounting • Detailed technical data mailed on request, however with the knowledge that this CHASSIS is a 30-tube #630 with both TECH-MASTER'S and OUR guarantee, you need not hesitate sending your order in now.

Complete Ready to Plug in and Play **\$262.50** (less CRT)
Special at

COMPLETE LINE OF #630 TECH-MASTERS

VHF entitles you to one UHF Station Free. UHF/VHF includes tuner covering all 82 channels.

MODEL 2430: For picture tubes up to 24". Audio connection for optional use of external amplifier.

UHF/VHF \$249.50 VHF \$189.50

MODEL 2431: Same as 2430, but with True Fidelity Push-Pull audio amplifier.

UHF/VHF 259.59 VHF 199.50

MODEL 2430-9: For new 90° kinescopes. (24" rectangular, 27" and 30").

UHF/VHF 299.50 VHF 262.50

MODEL 1930: Similar to 2430 with slight modifications including area control switch at rear of chassis and cadmium plated finish instead of nickel.

UHF/VHF 224.95 VHF 179.50

MODEL C-30: Designed for the utmost in Quality at an Economical price.

UHF/VHF 209.95 VHF 149.50

(All complete, ready to plug in. Prices NET. CRT not included)

DO-ALL VOLTMETER

Radio City Products, Inc., Easton, Pa., has introduced a new electronic Do-All voltmeter, model 657. It covers 62 individual electronic range measurements and combines a capacitance

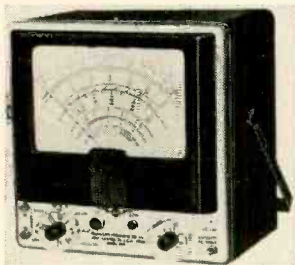

meter, a high-range ohmmeter, as well as conventional and low ranges, a v.t.v.m., a peak-to-peak v.t.v.m. and also an inductance meter with inductance measurements given by chart reference.

Capacitance measurements range from 1 μf to 1,000 μf . The ohmmeter has a 10-ohm center scale on the low range and the highest range is 10,000 megohms.

Both d.c. voltages and a.c. voltages are direct reading to 6,000 volts and do not require any external multiplier probe. There is also a zero center d.c. v.t.v.m. permitting discriminator and other voltage measurements showing plus or minus from center scale.

HI-FI CABINET

G & H Wood Products Co., 75 North 11 Street, Brooklyn 11, N. Y., has designed the Cabinart model 10 which



provides all the necessary space for a complete high-fidelity music system, plus a speaker baffle area of five cubic feet. The over-all dimensions of the cabinet are 35 x 35 1/2 x 17 1/2 inches. The record changer and radio compartments are 14 1/2 x 16 5/8 x 5 inches deep. The speaker compartment is 16 x 34 x 16 inches deep.

TIME-SAVING POCKET KIT

Hunter Tools, Whittier, Calif., has announced the development of the TV executive kit, which consists of a 1/4-inch nut driver, a small regular screwdriver, and a No. 1 recess driver.



The tools come in a plastic kit which fits snugly in the technician's shirt pocket. The tools are easily accessible and always handy, yet completely out of the way when not in use.

One of the uses of this kit is for

the removal of the back of all makes of TV sets without lugging out a complete tool box.

REDWOOD ANTENNAS

JFD Manufacturing Co., Inc., 6101 16 Avenue, Brooklyn 4, N. Y., has put out the Redwood 2-bay model UN102 and Redwood 4-bay model UN104

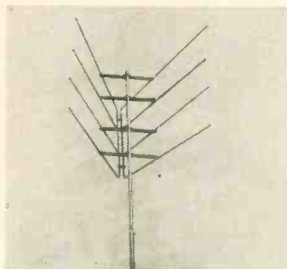

which offer complete reception on channels 2 through 83 without the necessity for couplers or double lines. The V-angle provides very directive reception on all three bands. The gain is aided by full-wave U-formed aluminum dipoles that lie vertically, forming a stacked V-angle at their juncture.

NEW ROTATOR

Brach Manufacturing Corp., 200 Central Avenue, Newark 4, N. J., has announced its new Sky Chief rotator. The rotator has a built-in thrust bearing, replaceable motor unit, and



adjustments for masts as large as 1 11/16 inches. A gear mechanism integrates high torque and positive anti-drift positioning into the rotator system. It has a unique flexible worm gear which is self-compensating and adjusts to the antenna load under rough weather conditions.

UHF SET COUPLER

RMS, 2016 Bronxdale Ave., New York 60, N. Y., has developed a 2-set u.h.f. coupler, model AC-2U. It is a printed-circuit unit, providing the necessary coupling without any interaction between the two ultra-high frequency TV receivers.

The unit also provides the necessary 300-ohm impedance required for the input and output circuits for maximum signal transfer. It is molded of mahogany-colored, nonbreakable styrene and mounts to any floor board or wall with the two wood screws that are provided. END



All specifications given on these pages are from manufacturer's data.

At Last!

a complete TUBE TESTER

\$24.90

for only



New EMC Model 208*

Pat. Pending tests all popular tube types quickly... easily... accurately... in the field or shop.

The sensational new EMC Model 208* gives you for the first time a complete precision tube tester for less than \$25.00.

With it you can quickly and accurately test all popular tube types for quality as well as shorts, leakages, filament continuity and opens.

MODEL 208 TUBE TESTER (COMPLETELY WIRED AND TESTED) Only \$24.90

MODEL CRA (PICTURE TUBE ADAPTOR OF MODEL 208) \$4.50

CHECK THIS EXCLUSIVE COMBINATION OF FEATURES:

1. Lowest market price
2. Completely portable
3. Checks all popular octal, loctal, miniature and noval base tubes
4. Flexible switching system assures complete testing of all present and future tubes types
5. Elements numbered according to RTMA base system
6. Individual sockets for each tube type
7. Checks completely for quality as well as shorts, leakages, filament continuity or opens between any two tube elements
8. Visual line voltage check with adjustable control assures accurate quality testing
9. Matches and checks HI-FI tubes such as 1614, KT 66, and 58E1
10. Space saving, high impact case, 5 1/4 x 6 3/4 x 2 7/8"
11. Comes complete with detailed instruction book and tube listings

An invaluable tool for: Servicemen, radio hams, HI-FI fans, students, hobbyists.

Write to Dept. RE-7 today for complete catalog & precision test equipment.

EXPORT DEPT. - 136 LIBERTY ST. N. Y. 6, N. Y.

EMC

ELECTRONIC MEASUREMENT CORPORATION
280 LIBERTY STREET
NEW YORK 13, N. Y.

ATLAS RADIALS

FOR CHURCHES

FOR FACTORIES

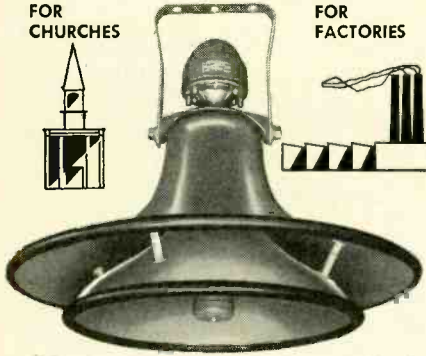

FOR TERMINALS

FOR CARNIVALS

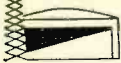

With uniform 360° coverage, non-resonant construction, and 100% storm-proofing, ATLAS Radial Driver Unit Projectors often solve the most difficult sound problems—are excellent for reproduction of speech, chimes and music. For complete details on Radials and the famous ATLAS line of Public Address and Microphone Stand Equipment . . .

WRITE NOW for FREE Catalog 553

ATLAS SOUND CORP.
443 39th St., Brooklyn 18, N. Y.
In Canada: Atlas Radio Corp., Ltd., Toronto, Ont.

NEW Grommes Custom



2 in 1 Tri-Linear-Triode AMPLIFIER

- Wider Frequency Range
- Higher Power
- Lower Distortion

New Grommes 216 BA Basic Amplifier
An improved version of two of the most popular amplifier circuits. *Triode* or *Tri-linear* operation is obtained by a special switch. In the *Triode* position, it operates as an advanced Williamson circuit. In the *Tri-linear* position, it becomes a super-powered tapped screen circuit. **\$99.50**

Ideal Pre-Amplifiers for Above

Model 206 PA De-Luxe Pre-Amplifier
Compact, simplified 4-knob control. Record compensator switch, other features. **\$55.00**

Model 210 PA Custom Pre-Amplifier
New custom equalizer. Step-type controls, many more hi-fi features. **\$99.50**

See Nearest Hi-Fi Jobber or Send Coupon!

PRECISION ELECTRONICS, INC.
9101-Et King St., Franklin Park, Ill.

Please rush Free Bulletin on new 216BA

Name _____
Address _____
City _____ Zone _____ State _____

NEW PATENTS

PULSE GENERATOR

Patent No. 2,666,861

Richard D. Campbell, Brookmont, Md.
(Assigned to Reed Research Inc., Washington, D. C.)

This circuit translates d.c. in to pulses. The number of pulses is proportional to the amplitude of the voltage. For example, if an input of 0.2 volt results in a single pulse, then a voltage of 0.8 would generate 4 pulses. The circuit is useful in computers and control devices.

A semiconductor is the heart of this invention. It may be of either P or N type conductivity. If it is P, it needs only one point-contact. The other contact is the crystal itself. If the semiconductor is N type, it needs two point-contacts. Either diode provides snap action, illustrated in Fig. 1. As voltage is fed to the crystal, low current flows at first. Then at some critical point A, the semiconductor breaks down and considerable flow occurs, as indicated at point B. If the voltage is lowered, the current is reduced to some

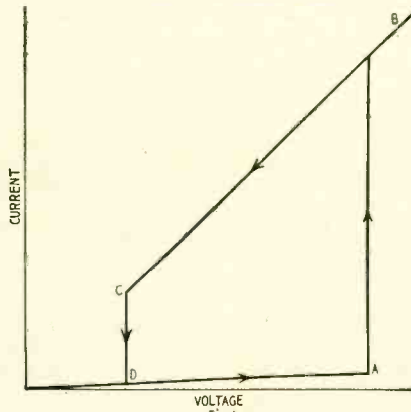

point C at which snap action again takes place. The current drops off sharply to the original point D.

Fig. 2 shows a pulse generator using an N type crystal. A positive signal is fed through capacitor C. At first the current through the crystal is small. At the critical point the crystal breaks down and considerable flow occurs. The pulse is detected in a receiver. Since the crystal is now almost a short-circuit, C receives

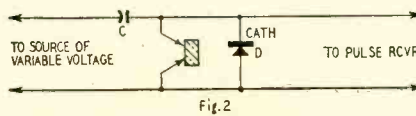

practically the entire voltage and begins to charge. The semiconductor is left with almost no voltage so it returns to a state of low conductivity. This marks the end of the pulse.

If the signal voltage continues to grow there is soon enough potential to break down the crystal again. This we have a second pulse, and so on.

When the signal ends, C can discharge through rectifier D. The diode also prevents application of reverse potential to the crystal which might cause damage to it.

MEASUREMENT OF COUNTER-E.M.F. OF A MOTOR

Patent No. 2,649,572

Oscar E. Carlson, Paterson, N. J.

Electromagnetic theory tells us that force is exerted on a current-carrying wire placed in a magnetic field. Conversely, when that wire moves through the field, induced current flows. These currents, the applied and the induced, flow in opposite directions. The induced flow is said to be caused by "counter-e.m.f." This invention permits measuring the counter-e.m.f.

Two tubes are used. V1 is a thyatron that rectifies the line voltage and delivers d.c. to the motor. Polarity signs are shown for the conducting half-cycle. V1 conducts and passes current through a motor. Also, a negative bias is impressed upon the triode V2, causing it to block. Meter M does not deflect.

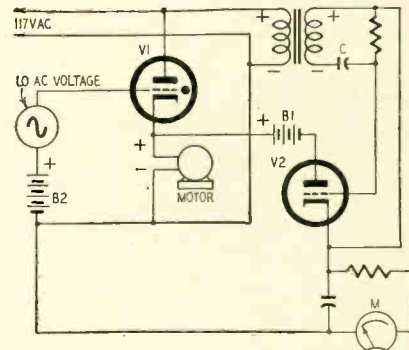

During the next half-cycle, V1 blocks and no current is applied to the motor. Of course this machine continues to turn over because of its inertia. During this time, counter-e.m.f. exists without applied voltage. The counter-e.m.f., like the applied voltage, is positive. It is fed to the plate of V2. Since the polarity has reversed, we find the grid of V2 is also positive, and this triode conducts. The meter deflects and indicates the magnitude of the counter-e.m.f. at the motor.

B1 prevents conduction of V2 until the counter-e.m.f. is sufficiently high to control tube current. B2 in series with low-voltage a.c. provides the thyatron bias. This a.c. is in phase with the line voltage.

SQUARE-WAVE GENERATOR

Patent No. 2,671,170

Augustus G. Douvas, Floral Park, N. Y.

(Assigned to Bell Telephone Labs., Inc.)

A cold-cathode tube acts like a switch. When ionized, it passes a steady current. At other times no current can flow. Therefore such a tube can make an efficient square-wave generator.

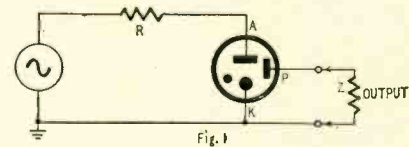
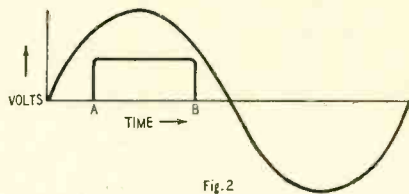

Fig. 1 shows a circuit using a triode gas tube. Input is applied between anode A and cathode K. A third element is shown at P, a probe which conducts the output current. The load is Z, a high impedance so that there will be negligible loading of the circuit. During nonconduction, P is at ground potential. When the tube is excited



a small current flows through Z and the probe potential goes positive.

Fig. 2 shows typical waveforms. The sine wave is the input voltage across the tube. At some critical voltage, the tube ionizes. This is shown at A, which marks the beginning of the square wave. Ionization continues until the input drops below the critical value. At this time the tube blocks again and the square wave ends (B).

In this patent the inventor also describes the optimum mechanical design for a tube that would provide best results in this circuit.

TAPE RERECORDING

Patent No. 2,666,813

Marvin Camras, Chicago, Ill.
(Assigned to Armour Research Foundation of Illinois Institute of Technology)

Tape has many advantages over other sound-recording methods, but it has one bad feature. It is difficult to record from a master tape to a

copy tape. While a disc can be used as a stamper to make many hundreds of copy discs, a tape cannot make copies so easily. This inventor, a pioneer in magnetic recording, has disclosed an improved method for recording on tape.

Master and copy tapes move past a sound head with two airgaps. (See diagram.) The master tape moves over the upper gap, generating an a.f. voltage through the head windings. This voltage energizes the second gap under which the copy tape is moving at the same speed as the master. The induced a.f. is mixed with a high-frequency biasing signal fed through leads A and B. Thus the copy tape is magnetized as required for a duplicate record.

To retain its original recording, the master should have a high coercive magnetic factor, at least twice that of the copy. The copy tape should have high permeability to pass the magnetic field of the head. Also, it is preferable that the master be pre-ared by subjecting it to an a.f. field equal to that of the sound head. If these precautions are taken, the master can be used to make many duplications without loss of its own magnetism.

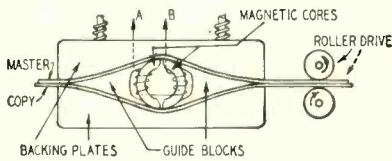

FREQUENCY MULTIPLIER

Patent No. 2,664,510

John S. Russo, Philadelphia, Pa.
(Assigned to Radio Corp. of America)

This multiplier is especially effective in the low r.f. range. For example, it can multiply a 100-ke fundamental signal to 500 to 600 kc.

The input feeds a 6AC7 or similar tube. Bias is provided by a grid leak, so only the signal peaks drive the tube into conduction. The plate network is tuned to the desired harmonic. Thus each pulse of excitation shocks the plate coil which oscillates at the harmonic frequency.

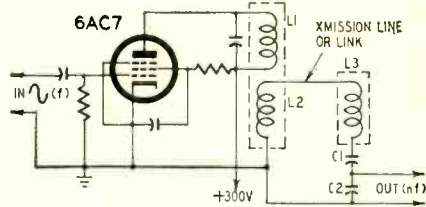

L2 feeds the harmonic to a series-tuned combination L3, C1, C2. The output voltage depends upon the Q of this output coil, so it should be as high as possible. C1, C2, form a capacitive divider which feeds the harmonic to the next stage.

The transmission line impedance should equal that of the series network. When this is done, the line may be long. END

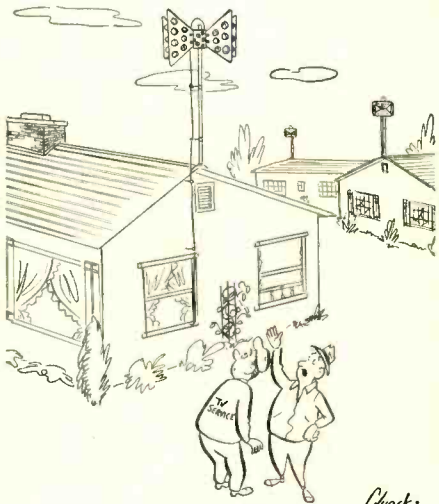

"It was bound to come."

Gleucke

An outstanding design for EVERY application

CORNELL-DUBILIER

UHF AND VHF TV ANTENNAS

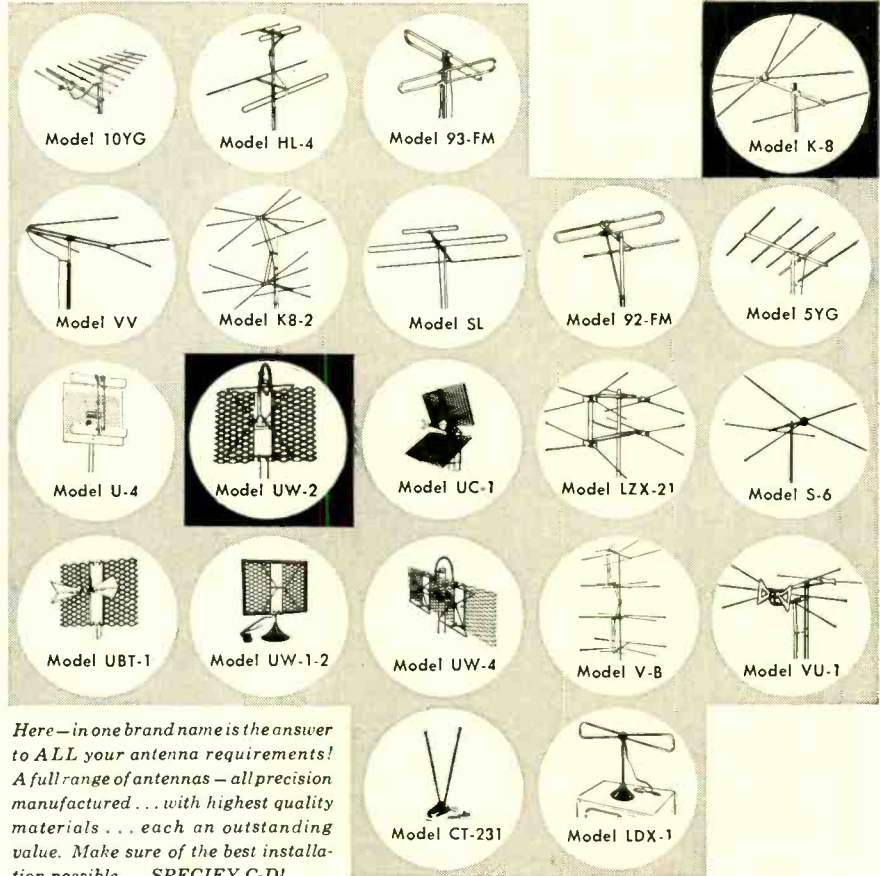

Here—in one brand name is the answer to ALL your antenna requirements! A full range of antennas—all precision manufactured... with highest quality materials... each an outstanding value. Make sure of the best installation possible... SPECIFY C-D!



CONSISTENTLY DEPENDABLE

CORNELL-DUBILIER

SOUTH PLAINFIELD, NEW JERSEY



ROTORS • CAPACITORS • VIBRATORS • ANTENNAS • CONVERTERS

SUBSCRIBERS

If you're moving, please don't forget to send us your address as it appears on the copy of the magazine, including the numbers shown beside your name, as well as your new address.

If we receive this information before the 20th of the month, you will continue getting the magazine without interruption.

Your cooperation will be most helpful and greatly appreciated.

VIDEO TUBES

AT WHOLESALE
100% GUARANTEED

Individually Boxed!
Branded! Same Day Service

29c ea.

39c ea.

Type	Type	Type	Type
5Y3	117Z3	1S5	6BE6
5Z3	1A4P	1U5	6C4
6X4	1C6	5U4	6F6
6X5	1C7	6AB4	6K6
35W4	39/44	6AL5	6S4
35Z5	35/51	6AT6	6SQ7
49	2A3	6AU6	6W4GT
80	2A7	6AV6	12AL5
75	1F5G	12AT6	25Z6
76	37	12AV6	35B5
77	36	12BA6	35C5
35Z3		12BE6	1E7GT
		12SQ7	1LC6
		25L6GT	1LC5
		25W4GT	7A4/XXL
			7Z4

49c ea.

59c ea.

Type	Type	Type	Type
1A7	5V4	1B3GT	6BD5
1H5	5V4	1L6	6J6
1L4	6AG5	1X2	6S8
1N5	6AQ5	3Q5	6SL7
1R5	6BA6	6BA7	6SN7
1T4	6BC5	12AU7	12SN7
1U4	6BH6	12AX7	6BY5G
3Q4	6BJ6	12BA7	7F7
3S4	6CB6	12BH7	7F8
3V4	6SA7	12SL7	7J7
6SD7	6SR7		
6SK7	7A6		
6V6	7A7		
12SA7	7A8		
12SK7	7B4		
50B5	7B5		
50C5	7B6		
50L6	7B7		
6AS5	7U5		

69c ea.

79c ea.

Type	Type	Type	Type
6AK5	6BL7	6BQ6	6BZ7
6AJ5	6L6	6BQ7	25BQ6
6BK7	6T8	6J8	14S7
6U8	19T8	7AK7	6B7
12AT7	1T5GT		
12AV7	6F7		
	6N6		
			1B4P

99c ea.

Type	Type	Type	Type
6BG6	19BG6	6BN6	3A8GT
6CD6	117L7GT	6CU6GT	

FREE! with every order of \$20.00 or more—famous "Oxwall" magnetic screw driver kit. Includes all sizes—Phillips head, long handles to get in those tight spots, etc. 7 screwdrivers in all. May be purchased outright. Last value \$4.85.
\$1.99 each **3 for \$5.50**

MINIMUM ORDER \$7.00

25% deposit with order. Balance C.O.D. If full remittance is sent, please include postage. Excess money will be refunded.

We have more than 250 types in stock at all times. Order your other needs at similar savings or write for quotations. Quantity Users—write for special discounts!

VIDEO ELECTRIC COMPANY
P. O. BOX 911 • NEWARK, N. J.

QUESTION BOX

AM WITH POLIC-ALARM SETS

Please print a diagram showing the changes necessary to receive AM signals on a Polic-Alarm PR-31A 30-50-mc FM receiver. I would like to add an AM-FM switch and cover the same band of frequencies.—S. J. P., Utica, N. Y.

The diagram shows how a simple AM detector circuit can be installed and switched into action at will. The diode plate connected to pin 6 in the 19T8 is unused in the original circuit. Use it as the AM detector.

Break the original wiring (shown in solid lines) at the points indicated and add the leads and components shown in dashed lines. Keep all leads short. The AM-FM switch S1-S2 may be a rotary type mounted close to the 19T8 and second i.f. amplifier sockets. Its control shaft should be long enough to extend through the chassis skirt at a convenient point.

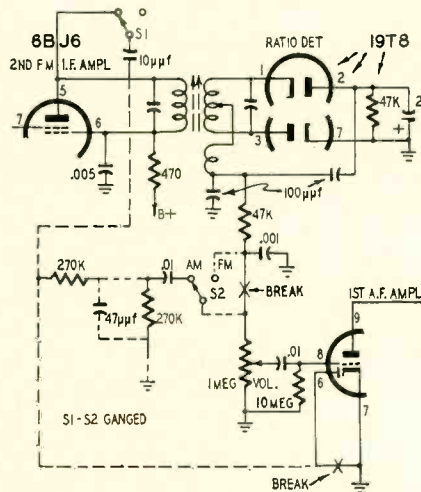

HARD-TO-FIND INDUCTORS

The tone-modulated radio-control receiver and transmitter circuits in Figs. 808 and 904 of "Model Control by Radio" require 2.82-, 6.55-, and 9.4-henry chokes. I cannot find these values listed in my catalogs. Is it possible that these inductance values should be in microhenries or in millihenries? Where can I obtain miniature lightweight chokes in the specified values for use in a model airplane?—J. S. H., Albertson, N. Y.

The values of the inductors are specified correctly in henries. They are used with .001-, .002-, and .003-µF capacitors to tune to frequencies of approximately 3,000, 1,380, and 955 cycles, respectively. UTC (United Transformer Co.) has a line of miniature, lightweight, toroid type inductors with the required inductance range. The MQE-15 has an inductance of 2.8 henries and weighs only 1.5 ounces. The MQA-16 and MQA-17 have inductances of 6 and 10 henries, respectively. You can use these with minor changes in the values of the tuning capacitors.

If you have an inductance bridge, you can remove laminations from small a.c.-d.c. type filter chokes until you get

the required inductance. Knowing the desired resonant frequency, you can determine the required values of inductance or capacitance from the formulas:

$$L = \frac{25,330}{F^2 \times C}$$

and

$$C = \frac{25,330}{F^2 \times L}$$

where L is in microhenries, C is in microfarads, and F is in kilocycles. If the capacitance needed for resonance at a given frequency is not available, use the closest commercial value smaller than that desired and shunt it with a variable that can be adjusted to tune the circuit to resonance.

49'ER FOR OLD TIMER

Please print the diagram of a set called the 49'er, described about 15 years ago in RADIO-CRAFT. It used two type 49 tubes powered by a pair of 1.5-volt flashlight cells.—W. R. O., Leeds, N. Dak.

The diagram shows the most popular version of the 49'er. The low B plus voltages on the plate and grid 1 improve sensitivity and volume. The tuned circuit consists of a 365-µF tuning capacitor and a broadcast antenna transformer designed for a high-impedance antenna. The primary is

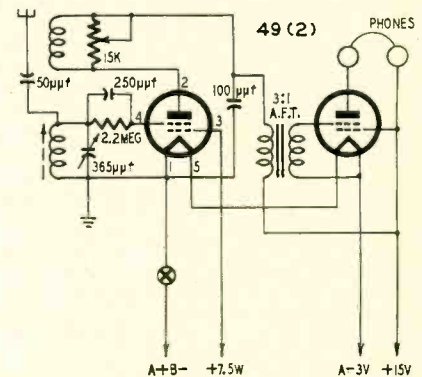

used as the tickler for the space-charge regenerative detector.

We would like to be able to recommend a more modern tube for this circuit but there is no equivalent or near-equivalent for the old 49.

STRING MUSIC PICKUP

Several years ago I constructed a pickup for a steel guitar from an article in your magazine. I have since lost the pickup and the magazine containing the article. Please reprint details on the construction of this instrument.—S. C., New York, N. Y.

Different types of magnetic pickups for steel-stringed instruments were described in articles in the September, 1939, October, 1943, December, 1947, and March, 1948, issues. The earliest issue is out of print and no longer available from this office. You may find a copy in a back-number magazine

store or on file at a library. The December, 1947, and March, 1948, issues are currently available from this office for 50c per copy.

The diagrams of the first two pickups are too extensive to be reprinted in this column, so we are reprinting details on the one in the March, 1948, issue.

The pickup is built around an Alnico V bar magnet $3/16 \times 5/16 \times 2\frac{5}{8}$ inches. The Alnico slug is polished on one narrow face and is magnetized longitudinally. If such a magnet is not available, a reasonably good substitute can be made from high-grade steel cut to shape and magnetized, preferably on a

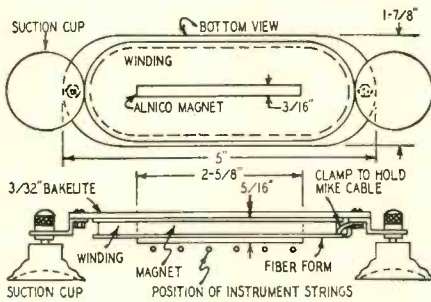

heavy-duty magnetizer at a local garage or machine shop.

The thin fiber coil form is shaped as shown, slotted to fit the magnet, and then glued with coil cement. When it is dry, remove the magnet and replace it with a piece of wood drilled in the center to pass a 1-inch 6-32 screw. Chuck this assembly in a hand drill or slow-speed lathe and scramble-wind the form full of No. 32 or smaller wire. (Wire smaller than No. 32 is harder to handle but gives greater output.) Solder two flexible leads to the coil ends for connections to the external circuit.

Cement the coil and magnet assembly to a $3/32$ -inch bakelite or fiberboard mounting plate and then solder the flexible leads to a length of microphone cable. The outside end of the coil winding goes to the shield of the cable. Add suction cups to hold the pickup in place over the strings. Adjust the mounting assembly so the pickup is as close as possible to the strings without touching.

The impedance of the pickup is high enough to permit its use directly in the grid circuit of a tube without a matching transformer. END



"You called, sir?"

JULY, 1954

LOOK TO THE LITTLE INDIAN  FOR

THE **BIGGEST** VALUE IN

MOLDED PAPER TUBULAR CAPACITORS

the Sangamo

Telechief



The Telechief will outlive all other tubulars! Major manufacturers' test and stamp of approval prove that

Telechiefs have longer life. They have a final insulation resistance value 10 to 15 times greater than any other paper tubular—because they're molded in HUMIDITITE!



The Telechief outperforms all other molded paper tubulars in moisture resistance... in high temperature operation... in holding its rated capacity under all conditions.

EXTRA VALUE AT NO EXTRA COST! This amazing new capacitor—that meets specifications so tough that no previously existing paper tubular could approach them—is a premium tubular at the price of an ordinary one. See your Sangamo Distributor today!

Those who know



choose Sangamo

SANGAMO ELECTRIC COMPANY

MARION, ILLINOIS

SC 54-11

precise TRANSISTOR KIT

Here is the unique PRECISE TRANSISTOR KIT that supplies you with all the components necessary to perform innumerable experiments . . . along with many prepared experiments including audio one stage amplifiers through transformer-coupled amplifiers . . . and into special circuits. Instruction book teaches you the theory of transistors in simple non-mathematical terms.

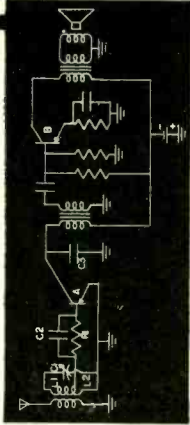

- ★ Audio oscillator
- ★ RF oscillator
- ★ Signal tracer
- ★ Tuned signal tracer (TRF type receiver), etc.

TI...Kit \$17.95

WRITE FOR
1954 CATALOG
INCLUDING
NEW HIGH FIDELITY
INSTRUMENTS IN
KIT & WIRED FORM

PRECISE DEVELOPMENT CORP.
Oceanside, New York

Super TV BARGAINS

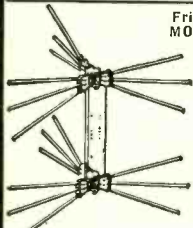

Fringe Master MOTORLESS DIRECTRONIC

- NO GHOSTS
- ELECTRONICALLY BEAMED
- NO MOTORS NEEDED
- NO INTERFERENCE

Model AX-599. 16-element, stacked array provides sparkling reception in city or fringe—all channels in all directions. Serviceman's kit provides 18 hi-tensil aluminum elements, 6-position Directronic Beam Selector, 1 set matched stacking bars, 75' TRI-X Cable, universal U-Clamp. Complete Kit...\$16.95

\$16.95

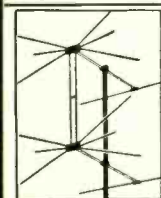

Tremendous Conical Bargain
2-Bay 16-Element Array
\$4.99 EACH IN LOTS of 3

With Hi-Band Adapters. Sturdy 3/8" Elements. SINGLE LOTS EACH \$5.30 This conical 2-bay 16-element array provides ultra-fine fringe reception. Includes sixteen 3/8 inch airplane type aluminum elements, including hi-band adapters for greater gain on the high channels and is complete with one pair of stacking bars to each array. These are packed in cartons of three 16-element arrays per carton, with the rods, at \$14.95 per carton. Single 16-element arrays, separately boxed—your cost \$5.30 each. 3 Two-Bay Arrays per carton without The Rods. \$13.50 carton. UHF-Fringe Stacking Assembly for Above—Model 4B. \$1.95 set.



UHF CORNER REFLECTOR
EACH IN LOTS OF 6
ONLY \$2.99
SINGLE LOTS \$3.50 EACH

This hi-gain UHF Corner Reflector can only be offered you at this low, low price for a short time. 8 to 11 db gain across UHF band. Order Model F-6.

NEW SPRING-SUMMER CATALOG AVAILABLE

ALL PRICES F.O.B. CLEVELAND, OHIO
Do not remit more than complete purchase price. Pay shipping charges on receipt of goods. 25% deposit on all C.O.D. orders, please. Money-back guarantee.

National Electronics
OF CLEVELAND
THE HOUSE OF TV VALUES

207 Delco Bldg. Cleveland 3, Ohio

RADIO-ELECTRONIC CIRCUITS

FM GENERATOR BASED ON A MULTIVIBRATOR

A new type FM generator has been disclosed by the Patent Office. It is based on a multivibrator which is excellent for this purpose because its frequency is easily swept over a wide range. The inventor had to overcome certain inherent disadvantages. For example, the output is rich in harmonics, therefore is far from sinusoidal. Also, the frequency tends to be unstable and may change with the slightest variation in plate voltage.

The new circuit is credited to Milton E. Mohr of New Providence, N. J. He assigned the patent (2,577,795) to Bell Telephone Laboratories, Inc.

tance of each unit and of the entire network C is determined by the voltage of B1. When a signal from A2 is added to the bridge, the capacitance varies about the average value. A positive signal decreases C.

L is the inductance of coils on a saturable reactor. Current flows from B2 through a saturating winding. This maintains L at some predetermined value. When signal current also flows through the saturating winding, the inductance of L varies about the average value. The greater the current flow, the lower the inductance of L.

As an example, suppose a positive sig-

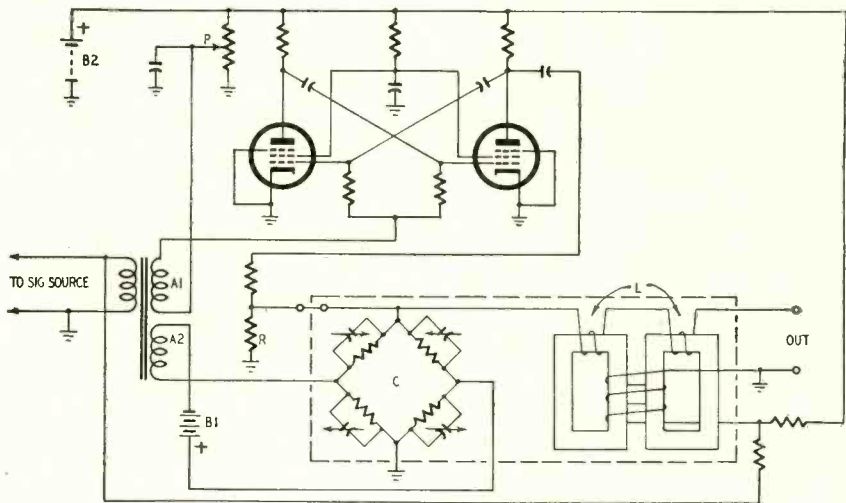

The basic schematic shows a balanced multivibrator, arranged for self-oscillation. The balanced circuit keeps even harmonics at a minimum. Components are chosen to provide the desired center frequency when no control signal is present. This frequency appears across the load R and is passed through a filter with two elements, C and L. The filter network is novel in that it has a variable cutoff. As the output frequency is swept higher or lower, the cutoff follows proportionately. Thus the filter does not affect the variable fundamental but it eliminates the harmonics.

C is the capacitance of a bridge network of capacitors and voltage-divider resistors. Each capacitor is of the ceramic type, for example one using barium-strontium titanate dielectric. The capacitance of each unit is varied by changing the voltage applied to the plates. When voltage is applied, the capacitance drops. The average capaci-

nal exists at A1. This causes the multivibrator frequency to increase as usual. If circuit adjustments are correct, there is a simultaneous decrease of C and also of L. Therefore, the cutoff of the filter is also raised. In an ideal case, the ratio L/C remains constant for a fixed filter impedance. However, the cutoff will vary in proportion to instantaneous frequency.

The center frequency of the output signal is stabilized by setting potentiometer P to the optimum value. The optimum setting can be found by varying the supply voltage B2 and noting the shift in frequency. If the voltage tapped off the resistor P is too low, the output frequency varies inversely as the voltage supplied by B2. If the voltage is too high, the frequency varies directly as the voltage at B2. When the arm of the potentiometer P is properly set, the frequency is fairly constant as B2 varies.

MULTIPURPOSE INSTRUMENT FOR NOVICE HAM

In their anxiety to get on the air, many newly licensed hams overlook the need for station accessories that compensate for their inexperience, by helping in adjusting the transmitter and antenna system. No ham station—particularly one operated by a novice—should be without a wavemeter or grid-dip meter to assure operation within the desired band without spurious radia-

tions, a field-strength meter for tuning the antenna for maximum radiation, and a monitor to keep tabs on the quality of the emitted signal.

The initial cost of these separate units is likely to tax the budget of the new ham, but this is hardly so when all are combined in a general-purpose unit like this one described by ZL4AH in *Break-In*, a New Zealand amateur magazine.

The circuit shown is a combination wavemeter, neutralization indicator, field-strength meter, and phone modulation monitor. For coverage from 2.5 to 75 mc, wind 4 plug-in coils as follows:

modulate the transmitter with a steady tone and increase the audio gain for 100% modulation on a scope or borrowed modulation meter. Tune the wavemeter to resonance, switch the meter to A.F. and reduce the coupling

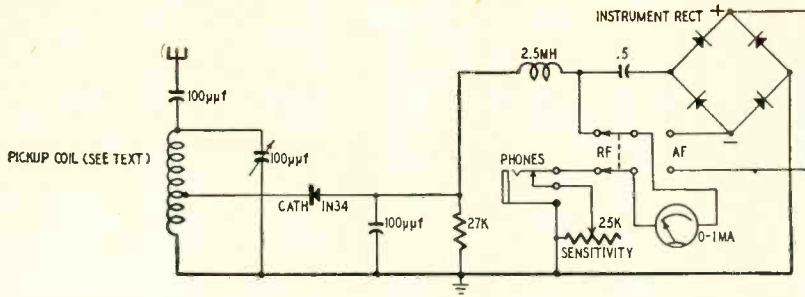

2.5 to 6.5 mc—31 turns No. 20 enameled wire close-wound on 1½-inch form. Tap 8th turn from bottom.

5.5 to 12.5 mc—15 turns No. 20 enameled wire spaced to ¼ inch on 1½-inch form. Tap 5th turn from bottom.

12 to 32 mc—5½ turns No. 20 wire spaced to ⅝ inch on 1½-inch form. Tap 2nd turn from bottom.

25 to 75 mc—6 turns No. 12 wire spaced ⅝ inch on ½-inch form. Tap 2nd turn from bottom.

You need a rigid antenna about 10 inches long when calibrating and using the instrument as a wavemeter. Use an accurately calibrated signal generator or variable oscillator to calibrate the vernier dial for the various bands. Place the instrument close to the circuit being checked or used for calibration and tune the variable capacitor for maximum swing on the meter. Reduce the sensitivity of the 25,000-ohm control for high accuracy.

To calibrate the modulation meter,

to the transmitter until the meter reads 0.8. Switch back to R.F. and set the sensitivity control so the meter gain reads 0-8. Note the setting of the sensitivity control so it can be reset to this point whenever the modulation meter is used. When the modulation monitor is calibrated, adjust the sensitivity control to the preset point, and then, with the meter set to R.F., adjust the coupling so the meter reads 0.8. The meter now indicates 100% modulation on negative peaks when the needle swings to 0.8 with the switch at A.F. Plug in headphones for aural monitoring.

As a field-strength meter, use a longer antenna if needed and tune for resonance. As a neutralization indicator, it operates as a wavemeter coupled closely to the plate tank of the stage being neutralized. Remove plate voltage from the stage and apply normal grid drive. Set the neutralizing capacitor for minimum indication on the meter.

SIGNAL TRACER FOR AUDIO AND RADIO FREQUENCIES

A 4-tube r.f.-a.f. signal tracer was described on page 74 of the August, 1952, issue. It uses separate 6SK7 r.f. amplifiers for the 175- and 456-kc circuits. I have simplified it by eliminating one of the 6SK7's and the associated components. The modifications are shown in the diagram. Miniature tubes were substituted for the ones used in the original unit.

The input circuits to the 6SK7 r.f. amplifiers were not tuned, so I was able to eliminate one stage by moving the

to ground through a 250-µf capacitor. The power amplifier remained the same except for the substitution of a miniature tube.

The adjustment of this circuit follows pretty much along conventional lines. The signal-tracer's 175-kc and 456-kc intermediate frequency transformers should be carefully aligned with an accurate signal generator.

The tracer can be used on signals from the mixer or converter plate to the second detector stage in radio re-

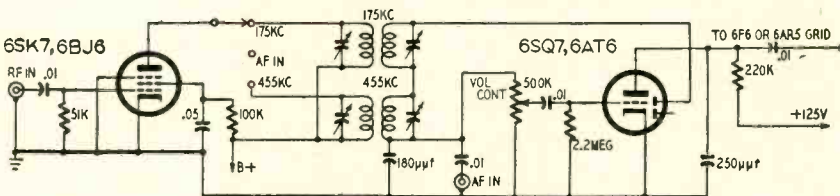

selector switch from the detector input to the plate of the single r.f. amplifier. I saved one switch section by connecting the transformer secondaries in series as shown. The changes in the audio circuit consisted of adding a .01-µf capacitor between the a.f. input jack and the volume control and bypassing the first a.f. amplifier plate

ceivers using an intermediate frequency of 175 kc or 456 kc. For tracing audio signals, be sure to use shielded leads. The output does not necessarily have to feed another amplifier; in many cases better indication can be obtained by using an audio frequency vacuum-tube voltmeter or an electron-ray indicator tube.—Francis R. Miles END

precise TEST INSTRUMENTS
(in KIT and WIRED FORM)

#111 #760 #308 #907

With professional and amateur alike, PRECISE is the foremost choice. PRECISE insures the use of the finest components in the finest precision-engineered equipment. Fully guaranteed, PRECISE instruments and kits use NO SURPLUS. What's more, kits contain easy-to-follow 3-color step-by-step instruction books.

Send for complete PRECISE 1954 Catalog JM which includes the amazing #111 Emission and Mutual Conductance TUBE TESTER.

PRECISE DEVELOPMENT CORP.
Oceanside, New York



"I believe all your troubles would vanish, Mrs. Kosgriff, if you'd simply get a JENSEN NEEDLE!"

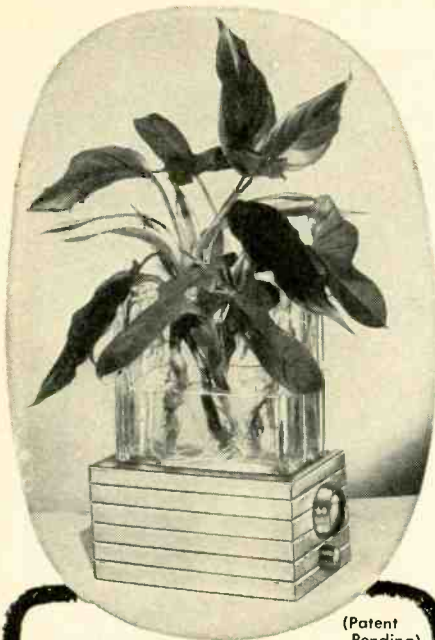

(Patent Pending)

Fen-tone UHF CONVERTER

... breathtakingly beautiful
... unsurpassed performance

The new Fen-tone creation is indeed a masterpiece of engineering and styling. Small wonder it created a sensation in the 1954 Radio Parts Show. Use the Fen-tone UHF CONVERTER as a lamp, an illuminated aquarium, an illuminated plant vase. You don't "hide" this decorator's dream piece!

List Price \$29.95

Fen-tone VHF Booster of similar design, list price \$29.95

INTRODUCING . . .

Fen-tone "REX"
3-Speed Automatic
Record Changer

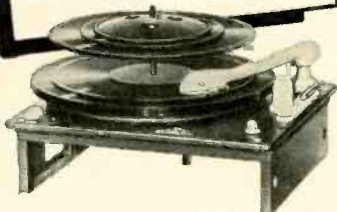

Created by craftsmen whose love for music inspired the finest phonograph instrument ever.

See Your Jobber

Literature on request.

FENTON Company

15 Moore Street, New York 4, N. Y.

TRY THIS ONE

A.C. VOLTAGE STANDARD

Most v.t.v.m. kit manufacturers suggest calibrating the a.c. scale by using the power line for accuracy of 5 to 10%, or, for greater accuracy, by using a known standard voltage.

The average tube tester provides a series of standard voltages suitable for calibration purposes when the line control switch or rheostat is set correctly. Set the filament selector to the desired test voltage and plug the test prods into socket pins 2 and 7 and set up the tester for any tube with the heater connected to these pins. Pins 2 and 7 have ample separation to prevent a short between the prods.—*G. P. Oberto*

(A tube-tester transformer supplies the rated voltages *under load* so it is advisable to use a tube or similar load for increased accuracy. Many testers have all the heater pins on different sockets connected in parallel so it is easy to plug a tube into one and test prods into another.—*Editor*)

IMPROVED FUSE CLIPS

Spring clips for the plates of horizontal output and high-voltage rectifier tubes make handy holders for fuses in TV circuits. If the fuse is in the horizontal output circuit, solder one clip directly to a lug on the transformer to hold the fuse firmly in place. The other end of the fuse is held in a clip on the end of a flexible lead. This scheme permits you to use fuses of different lengths and diameters that will not fit into a standard holder.—*Hyman Herman*

MATCHING ANTENNA TO BC-348

Many owners of BC-348 receivers complain that they cannot match the high input impedance of the set to a low-impedance coaxial or ribbon line. If your model is one of those with a panel-mounted antenna trimmer, it is easy to convert it to a pi-network antenna input circuit which provides a good match to low-impedance lines.

Simply connect a 365- μf variable capacitor between the antenna and ground posts on the set and adjust the set's antenna padders for minimum capacitance. (You may have to disconnect the padders on the higher frequency ranges.)

A 365- μf capacitor will suffice in most cases, but a 2-gang broadcast variable with a switch or clip between its sections will give a more flexible setup for various types of antenna feeders. Once you find the proper setting for the variable capacitor, you won't have to alter it until you change antennas. All you have to do is peak the incoming signal with the panel-mounted trimmer.—*Samuel H. Beverage, W1MGP*

INCREASING MIKE PICKUP

Acoustic feedback in PA installations often can be eliminated by increasing the microphone pickup from the front and decreasing it from the sides. One

WATCH

for the

**AUGUST Issue of
RADIO-ELECTRONICS**

At Your Dealers

JULY 23rd

EASY TO LEARN CODE

It is easy to learn or increase speed with an Instructograph Code Teacher. Affords the quickest and most practical method yet developed. For beginners or advanced students. Available tapes for beginner's alphabet to typical messages on all subjects. Speed ranges 5 to 40 WPM. Always ready—no QRM.

ENDORSED BY THOUSANDS!

The Instructograph Code Teacher literally takes the place of an operator-instructor and enables anyone to learn and master code without further assistance. Thousands of successful operators have "acquired the code" with the Instructograph System. Write today for convenient rental and purchase plans.



INSTRUCTOGRAPH COMPANY

4701 Sheridan Rd., Dept. RC, Chicago 40, Ill.

GET MORE WORK OUT OF YOUR

OSCILLOSCOPE

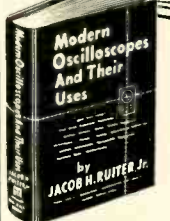

**MODERN
OSCILLOSCOPES
AND THEIR USES**

The most widely used book of its kind!

326 pages
370 pictures
Price \$6.00

Here, written so you can easily understand it, is a complete guide to the handiest, most widely used test instrument of them all—the cathode ray oscilloscope!

This big book, MODERN OSCILLOSCOPES AND THEIR USES by Jacob H. Ruiter, Jr. of Allen B. DuMont Labs gets right down to brass tacks. It shows *where* and *how* to use 'scopes on all types of AM, FM and TV service work . . . and on other electronic jobs as well. No fancy theory. You quickly learn how 'scopes work and how to use them for fast, accurate servicing from troubleshooting to set realigning and everything in between. You learn how to make connections; how to adjust circuit components; how to set the controls, and how to ANALYZE PATTERNS fast and right! Practice from it 10 days . . . at our risk!

Dept. RE-74, RHINEHART & CO., Inc.
232 Madison Ave., New York 16, N. Y.

Send MODERN OSCILLOSCOPES AND THEIR USES for 10-day FREE EXAMINATION. If I decide to keep book, I will then send you \$6.00 plus a few cents postage in full payment. If not, I will return book postpaid and owe you nothing.

Name

Address

City, Zone, State.....
OUTSIDE U.S.A.—Cash with order only. Price \$6.50. Money back if book is returned in 10 days.

way of doing this is to make a funnel from a hollow rubber ball and slip it over the front of the mike. By increasing pickup from the front of the mike, you can back down on the amplifier gain control and thus reduce the tendency for feedback to develop.

Obtain a 4- or 5-inch rubber ball and puncture it with the corner of a razor blade to release the gas and the small amount of liquid that is inside. Now, cut the ball in half and then cut the opening for the mike. Make the opening slightly smaller than the diameter of the mike case.

A plastic or aluminum funnel can be used instead of the rubber ball, but the ball makes a more snug fit because of its elasticity, and it can be compressed, wrapped with a rubber band, and carried in the pocket easily.—*Arthur Trauffer*

MOBILE ANTENNAS

When installing antennas on police radio cars, we eliminate drilling mounting holes in the body by making up a special bumper bracket for the antenna base. We took a 4 x 12-inch piece of 3/8-inch metal and formed it to fit the curve of the rear bumper. Then we made a right-angle bend in the top to provide a flat horizontal surface for mounting the antenna base. Next, we removed a bumper guard and drilled a hole in our bracket so it could be bolted securely between the bumper bolt and the guard.—*Stanley Clark*

ELIMINATING KEYING CHIRP

I have had a new v.f.o. here at W2OUX for some time, and it has been performing very well in every respect. One day recently I noted a keying chirp. Naturally I investigated the oscillator first, then the power supply, shielding, and all connections. Everything was in proper order. Finally I looked over the semi-automatic key very carefully.

Tests showed that at any speed the dots gave one tone while the dashes gave another. The tones differed by about 100 cycles. An ohmmeter indicated almost a short across the dash contacts, but the dot contacts had nearly 3 ohms resistance! Evidently this resistance interfered with normal oscillator operation. Pressure with a pair of pliers tightened the dot contact which is fixed to a spring arm. The chirp completely disappeared.

If you suspect this trouble in your own rig, the quickest test is as follows: Tune the receiver to the transmitter frequency and adjust the tuning or b.f.o. for a beat of about 500 cycles. Hold the dot contacts closed with one hand, while the other hand sends intermittent dashes. There should be no change in the note when the dashes are made. To test the dash contacts, hold these closed while closing the dot contacts intermittently.—*W2OUX*

SIMPLE MIKE STAND

It's easy to mount the new small crystal mikes, such as the Turner model 81 or Shure model 777 Slim-Ex, onto

an economical photolamp stand. An added feature is the ball-and-socket joint which allows the mike to be tilted to an angle.

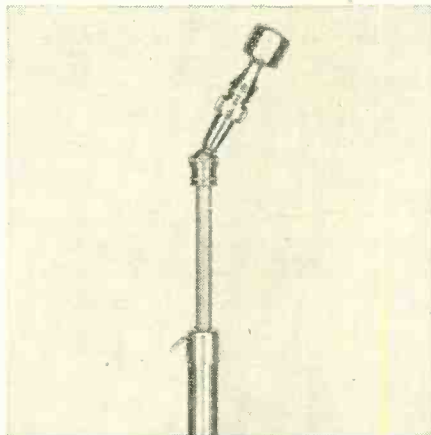

Since most photolamp stands have a 3/8-inch outside diameter top draw-tube, it is necessary only to thread the top of the tube with a 1/8-27 pipe die so the ball-and-socket joint can be screwed on. File off the 1/8-27 male threads on the neck of the swivel so it can be pushed into the opening of an Amphinol 75-MC1F or 75-MC1M (depending on the mike) cable connector, as shown. Spread a few drops of solder around the edges to hold the swivel and connector together securely; or saw a little off the end of the connector so its setscrew will contact the neck of the swivel. Pass the mike cable all the way through the tubes of the stand, and through the swivel to the connector. Solder the shield on the cable to the inside edge of the neck on the swivel before final assembly. The photo shows the Turner model 81 microphone.—*Arthur Trauffer*

ASBESTOS SHIELDS

I always carry a few small strips of sheet asbestos in my tool kit and use it whenever I'm soldering in or above a radio or TV chassis. A few pieces placed under tie lugs, resistors, or capacitors catch stray drops of solder and chute them out into the open where they cannot cause any damage. In tight spots, I use it to protect delicate components and leads from the heat of the iron. The material is soft and can be torn or cut when necessary to fit around leads. Above the chassis, I use it to prevent solder drops from falling into socket holes and plugging them. The asbestos strips also provide excellent insulation against soldering-iron heat when working close to components susceptible to high temperatures. This is especially true in the case of components such as peaking coils and waxed capacitors.

I use the thin sheet material sold by plumbing supply stores for wrapping heating pipes. Fifteen or twenty cents will purchase enough to last a long time. Considering the price of the asbestos it is a remarkably good investment, and as you carry it around you will find a great many more uses for it.—*Frank W. Dresser.* **END**

HBG*

is here!

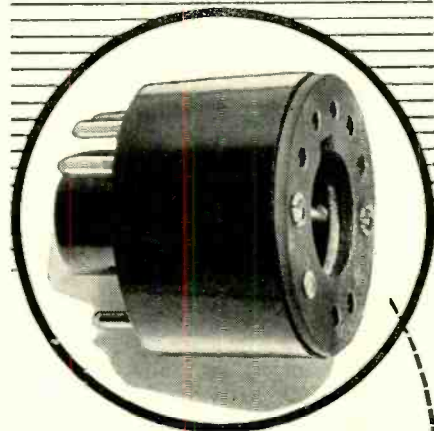

for Quick TV Set
Adjustment and
Alignment!

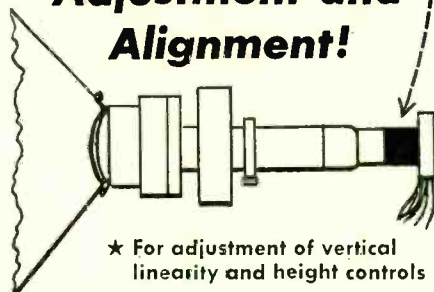

- ★ For adjustment of vertical linearity and height controls
- ★ Accurate positioning of focus coil or magnet
- ★ Precise setting of yoke
- ★ Complete with instructions



Dealer Net
\$1.95

See Your Jobber Today!



Export Scheel International
4237 N. Lincoln, Chicago 13, Ill.

The new Gernsback Library helps you learn more—earn more!

SERVICE TECHNICIANS—EXPERIMENTERS!

The more you know about electronics, the more money you can make! GERNSBACK LIBRARY Books offer one of the best ways of keeping up with the new and important in TV, radio and high fidelity. Just one tip from any of these low-cost books may be worth the price of the entire series to you! Check this list of titles and order the books you need today.

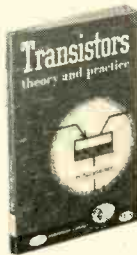

Transistors—theory and practice—No. 51

Rufus P. Turner talks transistors from the viewpoint of the practical man. Transistor applications in well-known circuits! Complete guide to the characteristics of commercial transistors. 144 pages. Illustrated. \$2.00

TV Repair Techniques—No. 50.

Top technician-writers tell how to recognize, find and correct quickly, the tricky TV servicing problems which stump even the experts. A few minutes reading this book can save you hours of servicing time. 128 Pages. Over 100 Illustrations. \$1.50



Radio & TV Test Instruments—No. 49.

How to build just about every instrument required for modern TV-radio servicing. Plus chapters on constructing a practical servicing bench and carrying case. 128 Pages. Over 100 Illustrations. \$1.50

High-Fidelity—Design, Construction, Measurements—No. 48.

An audio man's audio book. How to get top performance from a high-fidelity system. New 3-way approach. 21 top audio men wrote this book. 128 Pages. Over 100 Illustrations. \$1.50



Radio & TV Hints—No. 47.

Offers over 300 sure-fire hints, gimmicks, and short cuts on radio, TV and audio. Gathered from the hard-earned experience of experts. Grouped in seven sections. 112 Pages. 132 Illustrations. \$1.00

Television Technotes—No. 46.

Cut routine trouble shooting to the bone in TV servicing. Here are the symptoms, causes and cures of over 600 troubles which occur in scores of sets made by leading manufacturers. 128 Pages. \$1.50



Basic Radio Course—No. 44.

John T. Frye's classic on fundamentals! For the practical man who wants to learn theory. Covers everything from Ohm's Law to advanced servicing in a style which makes learning fun. 176 Pages. Cloth cover. \$2.25

5 CLASSICS ON RADIO AND AUDIO

- Radio Tube Fundamentals—No. 45**
Tubes for the technician. \$1.00
- Model Control By Radio—No. 43**
Theory and construction. \$1.00
- High-Fidelity Techniques—No. 42**
Best at any price. \$1.00
- Public-Address Guide—No. 41**
Earn money with P.A. 75c
- Practical Disc Recording—No. 39**
A complete guide. 75c

From the publishers of
RADIO-ELECTRONICS

See your distributor—or mail this coupon

GERNSBACK PUBLICATIONS, INC., Dept. 74
25 West Broadway
New York 7, N.Y.

Enclosed is my remittance of \$.....
Please send me the following books postpaid.

- 39 41 42 43 44 45
 46 47 48 49 50 51

Name.....
(Please print clearly)

Street.....

City..... Zone..... State.....

BUSINESS

Merchandising and Promotion

Technical Appliance Corp., Sherburne, N. Y., manufacturer of Taco antennas, recently completed a successful series of technical forums throughout Wisconsin, Iowa, Nebraska, and the upper Mississippi River Valley. The series was given by Ken Lippitt, the company's vice-president in charge of engineering.

Walso Electronics Corp., Los Angeles, has designed a new double-decker tool display for its complete line of alignment and specialty tools. The com-



compact unit provides space for all the company's alignment and specialty tools in less than two square feet of counter space.

The RCA Tube Division, Harrison, N. J., is under way on a promotion campaign to alert home TV set owners to the need of installing lightning arresters and of periodically checking antenna electrical connections on receivers. The program, "Operation Checkup," centers around a four-point installation check-up offered by TV service technicians. Window posters and direct-mail literature are being used to back up the campaign.

Raytheon Manufacturing Co., Receiving Tube Division, Newton, Mass., reports continued success with its "Service Saver" technical forums. Over 850 service technicians attended the recent Chicago meeting which was co-sponsored by Allied Radio Corp., and 1,500 attended the meetings held throughout the Northwest with the cooperation of local Raytheon tube distributors.

Mueller Electric Co., Cleveland, Ohio, is offering a new display board which mounts 18 of its most popular small clips and insulators. The 7 x 9-inch blue Formica board permits an effective display in a minimum space.

Channel Master Corp., Ellenville, N. Y., produced an interesting motion picture about TV antennas for the general public. The 13-minute sound movie, "The Vital Link," is now available for television and club promotion from Association Films, New York City.

Simpson Electric Co., Chicago, is continuing its TV servicing lecture and demonstration tour throughout the Midwest under the sponsorship of local electronic parts jobbers.

Alpha Wire Corp., New York City, has introduced standardization into the retailing of small quantities of wire for

service technicians, with the development of its new *Service Spool* assortment. The assortment consists of five types of wire commonly needed in general electronics work.

New Plants and Expansions

Orradio Industries, Opelika, Ala., manufacturer of Irish Brand sound recording tape, recently opened a new southern California warehouse in Los Angeles. J. Herbert Orr, president of the company, said that the expansion, which quadruples the floor space formerly occupied in Los Angeles, was necessitated by the upswing in the demand for Irish tape.

Raytheon Manufacturing Co., Waltham, Mass., officially opened its new \$2,000,000 electronics laboratory in Bedford, Mass., overlooking Hanscom Air Force Base. The company also announced plans to erect a new wing to its present administration building in Waltham to house advanced development and production facilities for ceramics.

Jensen Manufacturing Co., has acquired an additional plant in Guttenberg, Iowa, for the production of small speakers. The new plant makes space available in the company's Chicago Laramie Ave. plant which will be devoted to expanded production of high-fidelity speakers.

Precise Development Corp., Ocean-side, N. Y., moved to a new specially built factory to provide for its expanding manufacturing facilities. A month-long Open House will be held some time this summer.

Radio City Products moved its Engineering Department and Development Laboratories and General and Administrative Offices from New York City to Easton, Pa. The Purchasing Division and the New York City district sales office are now located at 101 West 31st St. The company has begun construction on an additional new building in Easton which will add about 5,000 square feet to the company's present facilities.

Tung-Sol Sales Corp. moved its Atlanta headquarters to new and larger quarters at 1859 Cheshire Bridge Rd., N.E.

Show Notes

The 1954 Western Electronic Show and Convention management has made arrangements for the addition of an 11,000-square-foot tent annex to the Los Angeles Pan-Pacific Auditorium to meet the demand for extra exhibit space at the show, August 25-27.

The 1954 High-Fidelity Show, which will be held in the Palmer House in Chicago September 30 through October 2, is already ahead of last year both in number of participating companies and in rooms under contract.

Production and Sales

RETMA reported factory production of 1,447,110 TV sets and 2,581,565 radios for the first quarter of 1954, as against 2,259,943 TV sets and 3,834,784

TELTRON TUBES

GUARANTEED! . . . LOWEST PRICES EVER!

All tubes individually boxed . . . unconditionally guaranteed for one year.

TYPE	PRICE	TYPE	PRICE	TYPE	PRICE	TYPE	PRICE	TYPE	PRICE
0Z4	.45	6X7	.40	6BK5	.75	6B8	.76	12BZ7	.63
1A7GT	.53	6Q7	.40	6BK7	.78	6B8	.76	12K7	.40
183GT	.62	6AB4	.43	6BL7GT	.78	6V3	.80	12SA7GT	.45
1HSGT	.51	6AC7	.65	6BN6	.90	6V6GT	.48	12SK7GT	.45
1L4	.51	6AG5	.52	6BQ6GT	.83	6W4GT	.43	12SL7GT	.60
1L6	.51	6AH4GT	.65	6BQ7	.85	6W6GT	.53	12SN7GT	.56
1L6C	.49	6AJ5	.96	6BY5G	.60	6X5GT	.38	12SQ7GT	.38
1N5GT	.51	6AK5	.96	6BZ7	.95	6X8	.80	198GG	1.48
1R5	.51	6AL5	.43	6C4	.41	6X8	.80	19T8	.71
1S5	.43	6AQ5	.48	6CB6	.51	7F8	.49	25BQ6GT	.82
1T4	.51	6AR5	.48	6CD6G	1.63	7N7	.49	25L6GT	.41
1U4	.51	6AT6	.37	6CU6	.95	12AL5	.43	25W4GT	.43
1U5	.43	6AU5GT	.60	6E6	.42	12AT6	.37	25Z5	.55
1X2	.65	6AU6	.43	6F5GT	.44	12AV6	.71	25Z6GT	.36
2A3	.35	6AV5GT	.60	6H6	.50	12AU7	.43	35B5	.48
2A7	.35	6AV6	.37	6AF4	1.02	12AU7	.58	35C5	.48
3Q4	.53	6AX4GT	.50	6A5GT	.49	12AV7	.42	35L6GT	.41
3Q5GT	.61	6AX5GT	.60	6J6	.61	12AV7	.73	35W4	.33
354	.48	6BA6	.56	6K6GT	.39	12AX4GT	.60	35Y4	.42
3V4	.48	6BA7	.58	6L6	.78	12AX7	.61	35Z5GT	.33
5U4G	.43	6BC5	.48	654	.41	12AZ7	.65	50A5	.49
5V4G	.49	6BE6	.46	658GT	.65	12B4	.72	50B5	.48
5Y3GT	.30	6BF5	.48	65A7GT	.45	12BA6	.46	50C5	.48
5Y4G	.40	6BF6	.48	65K7GT	.45	12B7	.58	50L6GT	.50
5Z3	.42	6BG6G	1.18	65L7GT	.60	12BE6	.46	Type 80	.40
6A8	.40	6BH6	.51	65N7GT	.60	12BY7	.65	117Z3	.33
		6BJ6	.51	65Q7GT	.38	12BM7	.61	117L7GT	1.20
								117Z6GT	.65

FREE \$7.20 list value Bonus Box of three 6SN7 tubes and 25 assorted resistors with each order of \$25 or more.

FREE GIFT OFFER One 6BG6G tube will be shipped FREE with any order accompanying this ad.

We now have a complete line of special purpose and transmitting tubes in stock.

Write for quotations on your requirements—Dept. T.
We guarantee your orders to be shipped the same day they are received!

Minimum order \$10.00. 25% deposit on C.O.D. orders—save parcel post charges. Orders accompanied with full remittance will be shipped prepaid anywhere in continental U.S.A. All orders subject to prior sale.

Send for Free complete tube listing

SPECIAL!

while they last **29¢** each 10 for \$2.50

Type	Type	Type	Type	Type
1A4P	1E7GT	19	34	37
1C6	1F4	1629	35	39/44
1C7C	1H4G	22	35/51	46
1D5GP	2A7	33	36	49
1D7C				1F5G

These specials are new, famous make individually boxed. Order now.

TELTRON ELECTRIC COMPANY

428 Harrison Ave., Dept. RE7, Harrison, N. J. Phone Humboldt 4-9848

AUDELS TV-RADIO SERVICE LIBRARY

HERE IS LATE INFORMATION IN A HANDY FORM FOR RADIO AND TELEVISION REPAIRMEN, SERVICEMEN AND STUDENTS

2 VOLS. \$6 COMPLETE \$1 A MONTH. PAY ONLY 1 MO.

AUDELS T.V.-RADIO SERVICE LIBRARY—Highly Endorsed—1001 Facts—Over 1552 Pages—625 Illustrations, Diagrams of Parts. Presents Important Subjects of Modern Radio, Television, Industrial Electronics, F.M., Public Address Systems, Auto, Marine & Aircraft Radio, Phonograph Pick-Ups, etc.

IT PAYS TO KNOW!
The Basic Principles—Construction—Installation—Operation—Repairs—Trouble Shooting. Shows How to get Sharp, Clear T.V. Pictures, Install Aerials—How to Test. Explains Color Systems, Methods of Conversion, Terms, etc. Includes Ultra High Frequency (U.H.F.)—Valuable for Quick Ready Reference & Home Study. Tells How to Solve T.V. & Radio Troubles—Answers Your Questions.

Get this Information for Yourself. 7 DAY TEST—ASK TO SEE IT!

MAIL ORDER

AUDELS Publishers, 49 W. 23 St., N.Y. 10, N.Y. Mail AUDELS T.V. RADIO SERVICE LIBRARY 2 Vols. \$6 on 7 days free trial. If O. K. I will remit \$1 in 7 days and \$1 monthly until \$6 is paid. Otherwise I will return them.

Name _____
Address _____
Occupation _____
Employed by _____ RE

The MAGNEMITE in Action Around the World!



- Dawson recording deep in Africa's Gold Coast.
- American Museum expedition in ranges of New Guinea.
- Dwight Cooke interviews for CBS all over Asia.

Wherever you go, whether it be to the North Pole or the bottom of an African diamond mine, it's not too far for the Magnemite, truly portable tape recorder, whose versatility and unflinching dependability has gained global popularity for itself.



You'll never grow tired carrying a Magnemite, since these units weigh as little as 15 lbs. complete with batteries. Letterhead size, this mighty little handful meets NARTB standards and will easily satisfy your most critical recording needs.

For the whole MAGNEMITE story write to Dept. RE:

AMPLIFIER CORP. of AMERICA

398 Broadway, N. Y. 13, N. Y.

THANK YOU, Mr. Serviceman

for naming



your preferred brand!

In a recent nationwide survey*, radio and TV servicemen were asked this question: "What brand of replacement speakers do you prefer? Why?" QUAM was first in number on mentions—almost 30% more than the next most preferred brand.

* Conducted by Brand Name Surveys of Chicago, Illinois, May 1954.

WHY?

here are some typical comments about QUAM speakers by these servicemen

- "Adjust-a-Cone feature-ruggedness"
- "Complete range of sizes and types"
- "Stand up best in service"
- "Include hardware for easier installation"
- "Good construction"
- "Listed in Sams' Photofacts"
- "Heavier magnets"
- "Good quality at a reasonable price"
- "Always satisfactory"

ask for **QUAM** the quality line, for **ALL** your speaker needs

QUAM-NICHOLS COMPANY

236 EAST MARQUETTE ROAD • CHICAGO 37, ILLINOIS

CHROME-PLATED 2 CELL PRE-FOCUSED FLASHLIGHTS

Individual cartons: 12 to box, \$3.72 doz.; gross lots \$3.60 doz.; case lots—50 doz., \$3.30 doz. Samples 50c each. Excellent promotional item. Distributors & jobbers only.

Free Catalog on Request

METALACE CORP.

2101 Grand Concourse, Dept. R, N.Y. N.Y.

ARKAY KITS

WORLD'S FINEST

RADIOS PHONOGRAPHS TV
TEST EQUIPMENT HI-FI

Write for FREE Brochure

RADIO KITS, INC. • 120 Cedar St., N. Y. 6

RADIO-ELECTRONICS is paying good rates on acceptance for original and unusual articles on audio, television, FM and AM servicing, as well as articles on industrial electronic equipment and applications. Send for a copy of our Authors' Guide. Address:

THE EDITOR RADIO-ELECTRONICS

25 West Broadway
New York 7, N. Y.

radios for the 1953 quarter. 1954 production is at approximately the same level as for the 1952 period.

It also reported the retail sale of 1,780,795 TV sets for the first quarter of 1954. This almost exactly equals the figure for the 1953 period. Radio sales for the first three months of 1954 totaled 1,059,336 (exclusive of automobile sets), as against 1,438,866 for the 1953 period.

RETMA announced that manufacturers had sold 1,962,864 cathode-ray tubes valued at \$41,995,088 for the first quarter of this year, compared to 2,798,921 worth \$67,696,464 in the 1953 period. 76,385,978 receiving tubes were sold this year, as against 122,058,756 for the 1953 quarter.

Business Briefs

... Tung-Sol Electric Co., Newark, N. J., celebrated its 50th anniversary with a dinner at the Military Park Hotel, Newark, N. J. Harvey W. Harper, chairman and founder of the company, and Louis Rieben, president, were honored by more than 400 leaders in the automotive, electrical, and electronics fields. Donald A. Quarles, assistant Secretary of Defense for Research and Development, was a guest speaker at the event.

... Raytheon Manufacturing Co., Receiving Tube Division, Newton, Mass., delivered its first 15GP22 color picture tube to American Television, Inc., New Haven, Conn., distributor.

... Dage Electric Co., Beech Grove, Ind., states that the company should not be confused with Dage Electronics Corp. which was recently purchased by Thompson Products. Dage Electric, which manufactures a complete line of special and standard r.f. connectors and cable assemblies, recently expanded its manufacturing facilities.

... RETMA recently took steps to increase its revenue by voluntary contributions, to implement its program for industry self-regulation of TV interference, and to set up policy committees to direct RETMA activities on the radio-TV excise tax and u.h.f. television. The association also voted to present special certificates to all members and alternates of the recently disbanded NTSC.

... Radar-Radio Industries of Chicago, Inc., a nonprofit trade association of electronics manufacturers, which served Government agencies in a liaison capacity during World War II and the Korean War, has gone on a stand-by basis. Headquarters will be maintained at No. 1 N. La Salle St., Chicago, with present directors serving as an emergency committee.

... Westinghouse Electric Corp. will close its radio and TV assembly plant in Sunbury, Pa., on August 27, consolidating all production operations at the division's headquarters plant in Metuchen, N. J. Westinghouse has offered to sublease the Sunbury plant rent-free until February, 1956, to any employer willing and able to provide 1,000 or more jobs for Sunbury people.

... The Conference Co-ordinating Committee comprising membership from six trade associations in the electronics industry, recently adopted a set of governing policies which the committee agrees to follow in co-ordinating regional conferences run by sales representatives. The committee will support a maximum of four regional conferences in any one calendar year. For the balance of 1954 it has lent its support to conferences to be held by the Paul Bunyan Representatives in Breezy Point, Minn., July 8-11; the Rocky Mountain Chapter of The Representatives, August 29 - September 1; and the Heart of America Chapter at Lake Taneycomo, Mo., September 19-September 22.

... RETMA celebrated its 30th Anniversary this year during its annual convention, June 15-17, in Chicago.

... Sylvania Electric Products, New York City, was awarded the annual "NATESA Friends of Service Management" plaque for 1953.

... RETMA membership reached a new high of 383 when the following 17 new members were admitted to the association:

ACF Electronics, Alexandria, Va.; Boeing Airplane Co., Seattle, Wash.; Calvideo Tube Corp., Los Angeles, Calif.; Cargo Packers, Inc., Brooklyn, N. Y.; Collins Radio Co., Cedar Rapids, Iowa; Condenser Manufacturers, Inc., Nashville, Tenn.; Connector Corp., Chicago, Ill.; Consolidated Vultee Aircraft Corp.; Pomona Division, Pomona, Calif.; Elcon Electronics, Inc., Brooklyn, N. Y.; Elgin Metalformers Corp., Elgin, Ill.; Hy-Gain Television Products, Lincoln, Neb.; International Telemeter Corp., Los Angeles, Calif.; Maurice I. Parisier & Co., New York, N. Y.; Southern Electronics Co., Greenville, Tenn.; TRESKO (Transformer and Electronic Specialties Co.), Philadelphia, Pa.; Viking Electric, Los Angeles; Wire Company of America, Santa Barbara, Calif.

... Sarkes Tarzian, Rectifier Division, Bloomington, Ind., published an open letter to service technicians allowing them credit for replaced selenium rectifiers when returned to distributors. Distributors in turn are allowed credit against purchases. G. Eannarino, director of the division, says the offer is being made to alleviate the critical selenium supply situation. END



"I got so mad fishing around for good programs, I converted it into an aquarium."

Now! HANDLE TELEVISION SERVICE THIS NEW "SHORT CUT" WAY!

Locate TV troubles at a glance... Fix 'em twice as fast!



PIX-O-FIX TV TROUBLE FINDING GUIDES

by Ghirardi & Middleton
The looks of the picture on a bad TV receiver can tell you at a glance what is wrong. PIX-O-FIX not only makes this easy—but also show how and where to make repairs.

PIX-O-FIX No. 1—Identifies 24 common troubles by actual TV screen photos. Gives 192 causes and 253 remedies for these troubles. Price separately, \$1.25.

PIX-O-FIX No. 2 (New)—Covers 23 additional troubles not included in No. 1. Together, the 2 volumes are a comprehensive guide to easy "picture analysis" servicing of any TV set. Price separately, \$1.25.

SPECIAL! Get both PIX-O-FIX No. 1 and No. 2 for only \$2. Use coupon.

NEW! PIX-O-FIX No. 2 JUST OUT!

Users of PIX-O-FIX No. 1 were so enthusiastic about it that No. 2 has now been issued to include 23 TV receiver troubles not previously covered. Get both at bargain price of only \$2... a saving of 50¢!

HANDLE 90% OF TV TROUBLES BY EASY PICTURE ANALYSIS!

Cut TV testing time to minutes! Make repairs fast and right! Just turn the dial of the Ghirardi PIX-O-FIX. When the TV screen image in the PIX-O-FIX "window" matches the image on the set you're repairing... you've got your clue as to what is wrong! PIX-O-FIX then gives you all causes of this particular trouble plus the section of the receiver in which it has probably happened. Next you get step by step repair instructions. Usually, the component likely to be faulty is specified. Quick tests to apply to it are explained—or parts substitution recommended where this is the best procedure. The two PIX-O-FIX units cover 47 different kinds of TV trouble—just about anything you're ever likely to be called on to fix. Operation is simple and easy. Our money-back guarantee protects you fully.

10-DAY MONEY-BACK GUARANTEE

Dept. RE-74, Rinehart & Co., Inc.
232 Madison Ave., New York 16, N. Y.

Enclosed find \$_____ for which please rush the following:
 PIX-O-FIX No. 1 (\$1.25) PIX-O-FIX No. 2 (\$1.25)

BOTH PIX-O-FIX No. 1 and No. 2 at the special price of only \$2.00 for two plus postage
If not satisfactory, I will return PIX-O-FIX postpaid in 10 days and you guarantee to refund the purchase price.

Name _____
Street _____
City, Zone, State _____

OUTSIDE U.S.A. \$1.50 each. \$2.50 for both.
Same return privilege with money refunded.

Pat. Pend. ONLY \$4.95
Ppd. or COD + Chgs.

THE NEW TV DYNATRACER

- TRACES TV SIGNALS AND VOLTAGES
- LOCATES DEFECTIVE COMPONENTS
- REQUIRES NO ADDITIONAL EQUIPMENT

Ideal for trouble-shooting television sets in home or shop. Outperforms more expensive testers and pays for itself on first repair. A "MUST" FOR EVERY TV TECHNICIAN.

The "DYNATRACER" is a self-powered quality test instrument that traces TV signals through any Video, Sound, Sync, AFC, Horizontal or Vertical Sweep Circuit—isolates trouble to a stage or component.

Traces voltages (50/500 V. AC/DC). Also locates open, shorted, intermittent or leaky (up to 20 MEG-ohms) condensers, resistors, coils, XFormers, etc. Complete with Instruction Manual and Repair Guide

FREE 10 DAY MONEY-BACK GUARANTEE
With each new order we'll include a unique "TV High Voltage Indicator" useful in your testing work. Cut out advertisement... attach name and address with \$5.00 bill, check or money order and mail to

Century ELECTRONICS CO.
211-04 99th Ave., Dept. 115
Queens Village, N. Y.

TELEVISION

Big demand for graduates
B.S. DEGREE IN 27 MONTHS in radio including TV engineering—VHF, UHF, AM and FM. Students use over \$100,000 worth of equipment including 2 large commercial type transmitters in new TV lab. Intense specialized course includes strong basis in mathematics, science and advanced design in radio and TV. Hundreds of young men each year are earning engineering degrees in this recognized institution. Start any quarter. Many earn a major part of expense in this industrial center. Low tuition. Competent instruction. Thorough, intense, practical program. Also **B.S. DEGREE IN 27 MO.** in Aeronautical, Chemical, Civil, Electrical and Mechanical Engineering. G.I. Gov't approved. Enter Sept., Dec., March, June. Free catalog. **ENROLL NOW.**
INDIANA TECHNICAL COLLEGE
1774 E. Washington Blvd., Fort Wayne 2, Indiana

New EICO PROBES

SCOPE PROBES

SCOPE DEMODULATOR PROBE
KIT \$3.75 WIRED \$5.75

LOW CAPACITY PROBE
KIT \$3.75 WIRED \$5.75

DIRECT PROBE
KIT \$2.75 WIRED \$3.95

SPECIAL ALL 3 SCOPE PROBES Kit... \$9.95 Wired \$14.95

VTVM PROBES

VTVM RF PROBES
KIT \$3.75 WIRED \$4.95

PEAK-TO-PEAK PROBES
KIT \$4.95 WIRED \$6.95

SENSATIONAL HIGH VOLTAGE PROBE Model HVP-2
ONLY... \$4.95

See these amazing probe values at your jobber today. Write now for FREE catalog CP-7. Read EICO's other ads in this issue—turn to Advertisers Index!

EICO PAT. APP. FOR
ELECTRONIC INSTRUMENT CO., Inc.
84 WITHERS STREET, BROOKLYN, NEW YORK

THE TEST OF TIME

Has proven
ROHN TOWERS
Superior!

IN CONSTRUCTION

Rohn Towers are built of heavy duty tubular steel electrically welded throughout by skilled workmen exactly to specifications. Proof of Rohn construction lies in the fact that thousands of towers have been sold in the past several years and have successfully withstood the rigors of time in all climates and under the severest of conditions!

IN PERFORMANCE

Rohn Towers assure you of trouble-free performance and once installed give unquestioned satisfaction year in and year out! You are free of complaints because over the years Rohn Towers have proved themselves from the serviceman, dealer and customer point of view!

IN SALES

Sales acceptance has been phenomenal — thousands have been sold coast-to-coast — and the design has been one which has withstood every test known! Why "experiment" with an unproved tower design when you can sell Rohn?

So we ask you, "Why take chances with an untried tower? Be sure — sell Rohn — the only tower of its kind to withstand every test!"

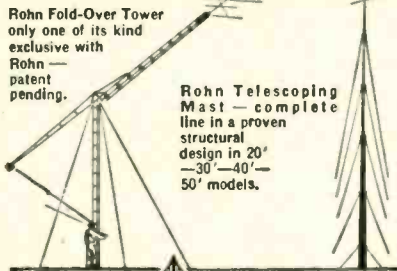

MANUFACTURING CO.
DEPT. RE 116 LIMESTONE BELLEVUE
PEORIA, ILL.



3 Self Supporting Rohn Towers To Fit Your Every Need

The No. 5 — The self-supporting tower for use up to 40', or guyed to 80'. An economical, yet sturdy, permanent tower!

The No. 10 — The standard 12' design that is self-supporting to 50' and can be installed to 120' when guyed!

The No. 20 — The heavy duty Rohn Tower, ideal for communication and where great height is required — self-supporting to 60', or guyed to 150'!

All Rohn Towers are in 10' sections — easily erected, transported and stored!

A COMPLETE LINE OF TOWER ACCESSORIES AND HARDWARE

A full line of Superior Design Tower accessories is available including guying brackets, house brackets, wall mounts for towers and masts, special tower bases such as peak and flat roof mounts, etc.

Contact your Rohn authorized representative or your distributor for FREE CATALOG or write . . .

MISCELLANY

ELECTRONIC DICTIONARY

- AMPLIFIER—Device for taking noise and making it louder.
- D.B.—Part of the sentence, "Abie, see de bee?"
- DIPOLE—What Stroganoff said as he shot Czernizowski.
- ENGINEER—Locomotive driver who owns a TV set.
- GRID—Football field.
- HAM—Trailing edge of an uncouth animal.
- KILOCYCLE—Dangerous two-wheeled vehicle.
- MICROMICROFARAD—One of the Rofarad brothers—the one who stutters.
- MULTIVIBRATOR—Bump and grind artiste.
- OHM—A H'englishman's castle.
- PENTODE—Convict frog.
- POLYDOPE—Unintelligent parrot.
- 6D6—Main highway between Chicago and Los Angeles.
- 6N7—Thirteen.
- SQUARE WAVE—Unsophisticated female Navy personnel.
- SYNC—What is done to a ship to get rid of the rats.
- TECHNICIAN—Resident of Texas.
- TRANSISTOR—Female having no fixed home, wandering from place to place.
- TOROID—Sign of the Zodiac under which most electronics engineers are born.
- YAGI—Hindu holy man.—Charles Hendrix

GIRL'S DORMITORY



"What do you mean, Miss Loring's set was in bad shape!?"

RADIO • TELEVISION SERVICEMEN!

HERE IS YOUR 1954 OPPORTUNITY TO DEVELOP A PROFITABLE SMALL APPLIANCE REPAIR SERVICE WITH PRESENT SHOP EQUIPMENT

We supply a complete program designed to maintain you in the highly profitable traffic appliance repair field.

ELECTRIC SWEEPER SERVICE CO.

"The House of **ESSCO** 100,000 Parts"

2034 EUCLID AVE. • CLEVELAND 15, OHIO



Free!

Get More Service Calls with

EICO DECALS

For Store Windows & Cars.

Write EICO

Brooklyn 11, N.Y. Dept. DC-7

ENJOY 3 COLOR TELEVISION FILTER SCREEN NOW

Changes dull eye-straining black and white pictures into beautiful color tones. Seconds to attach. No tools used. Helios eliminate glare and snow in fringe areas. Order direct. Send \$1 for screen size up to 16", \$1.25 size 17", \$1.50 size 20", \$2 size 21", \$2.50 size 24", \$3 size 27". (Also available are single solid color screens in blue, green, or amber.) Prices on solid color screens are 10% less. We pay postage except on C.O.D. orders. Satisfaction guaranteed. Inquiries from dealers also welcomed.

Zingo Products, Johnstown 13, New York

PEOPLE

Norman C. Owen was elected president of Webster-Chicago Corp., Chicago, at the annual stockholders' meeting. He was formerly vice-president in charge of sales. Peter Jensen, president of Jensen Industries, Chicago, was elected to the Board of Directors of Webcor.



Norman C. Owen

C. Chandler Cole joined Ward Products Division of The Gabriel Co., Cleveland, Ohio, as general manager. He was formerly a top executive with several industrial firms in the Chicago area.



C. Chandler Cole

Ray L. Triplett, president of Triplett Electrical Instrument Co., Bluffton, Ohio, is celebrating his 50th anniversary in the electronics industry. He was



W. L. Nylan, Sr., presents Ray L. Triplett with the Oriental "God of Good Fortune."

honored recently while on a trip to Hawaii with the presentation of the Oriental "God of Good Fortune" by W. L. Nylan, Sr., president of a Honolulu distributor firm.

Robert L. Klabin was promoted to vice-president and general manager of the newly created Elizabeth Division of General Instrument Corp., Elizabeth, N. J. He was formerly controller and general manager of the F. W. Sickles Division plant in Danielson, Conn.



Robert L. Klabin

Ralph C. Seiler joined Triad Transformer Corp., Venice, Calif., as assistant sales manager. He was formerly plant manager of West Coast Electronic Co.



Ralph C. Seiler

Obituary

Maurice S. Despres, a member of the Board of Directors of Admiral Corp., and founder and president of Dale Distributing Co., New York and New Haven, died in New York City after a long illness.

Personnel Notes

... Jerome J. Kahn, widely known electronics executive, has been retained by John H. Chatz, principal trustee of Crescent Industries, Inc., Chicago, to spearhead reorganization of the company and establish profitable production, sales, and promotion policies.

... Robert C. Sprague, chairman of the RETMA Board of Directors and chairman of the Board of Sprague Electric Co., North Adams, Mass., was awarded the association's Medal of Honor at its annual convention in Chicago, June 15-17. Robert S. Gates, executive vice-president of Collins Radio Co., was elected a director-at-large of RETMA. This was the first such election since a change in the by-laws last year permitting the board to name up to 10 directors-at-large.

... V. H. Lawrence was named vice-president of Industrial Relations of Jones & Laughlin Steel Corp., Pittsburgh, Pa., succeeding W. R. Elliott who is retiring. Elliott will remain with the company temporarily as a consultant to the president.

... Ted Martin, Jr., pioneer field sales representative, was promoted to a special assignment sales post by the RCA Tube Division, Harrison, N. J. He will operate out of the division's home office.

... David D. Coffin, manager of Raytheon Manufacturing Company's Missile and Radar Division, was named assistant vice-president of the Waltham, Mass., firm.

... William (Bill) Edwards joined Oxford Electric Corp., Chicago, as sales engineer. He has had 25 years of experience in the speaker field with such companies as Utah Radio Products and Crescent Industries.

... Carlos L. Bailiff, George McAlister, and Hugh L. Overbey, Jr., were appointed district sales managers in a realignment of sales territories by Channel Master Corp., Ellenville, N. Y. Bailiff now covers Alabama, Columbus, Ga., and Pensacola, Fla.; McAlister covers Florida; Overbey covers South Carolina, Georgia, and Chattanooga, Tenn.

... Richard O. Kennedy, Jr., joined Allen D. Cardwell Electronics Productions Corp., Plainville, Conn., as assistant to the president. He was formerly a management consultant to manufacturing concerns. The Cardwell Company is a subsidiary of Chesapeake Industries, New York City.

... Raymond B. George, vice-president of merchandising for Philco Corp., Philadelphia, has expanded his responsi-

EDLIE

says

"SAVE ON 3-WAY Portable KITS"

and other KITS and WIRED UNITS

3-Way Portable RADIO KIT AC/DC Batteries

NEW, compact, lightweight portable radio kit with the very latest supersensitive superhet. circuit. Wonderful reception from either batteries, or 115 V., 50-60 cycle AC or DC. Includes all complete parts (except wire & solder) necessary to build a great sounding radio.

Also includes circuit diagrams and simplified, complete step-by-step instruction folder which makes assembling easy. Housed in a beautifully high-glossed Catalin cabinet in two delightful and distinctive colors; maroon or alabaster (ivory). Size: 9 1/2" x 5 7/8" x 4 3/4". Includes tubes!

\$13.95
(maroon or Ivory)

TERRIFIC VALUE!

5 TUBE AC/DC Superhet Kit

Kit #1: 5 tube superhet kit, AC/DC includes all quality components required to construct this latest design, highly sensitive superhet broadcast receiver, complete with black, glazing bakelite cabinet (excludes wire & solder). Kit of 5 tubes. 12AT6, 2/12-BA6, 12BE6, 35W4, 50B5.

Price, Less Tubes..... **\$7.95**
Extra for Tubes..... **\$3.25**

Great Savings!

6-TUBE RADIO KIT

Kit #2: Low priced 6-tube kit designed for extra high sensitivity, excellent selectivity and good, rich tone quality. Uses 25L6, 25Z6, 6SQ7, 6SA7, 2/6SK7 in an easily constructed circuit. Includes all parts: punched chassis, resistors, condensers, coils, sockets, PM speaker, hardware, etc.

Special closeout price. (Less tubes & cabinet)..... **\$6.95**
Matched set of 6 tubes for kit..... **\$3.25**

Phono Oscillator

NEW SAVINGS! NOT A KIT!

Wireless phono oscillator transmits recording for crystal pickups or voice from carbon mike through radio without wires. Can also be used as an intercom by using PM speaker as mike (less tubes) **\$2.95**

With complete set of tubes..... **\$3.95**

3 TUBE PHONO AMPLIFIER

NOT A KIT

An assembled unit ready for installation using tone and volume control and 6 ft. rubber cord, (less tubes). **\$2.95**

Lowest Price!
With complete set of tubes..... **\$4.45**

PRECISION RESISTOR KIT

Consists of 50-1% Wilkor carbofilm resistors of 50 different ohmages, housed in a transparent plastic box. May be combined in series or parallel to produce almost any desired ohmage. Each resistor retails for about 85c.

Terrific Cash Saver!
Kit of 50 **only \$2.45**

EDLIE Electronics

154 Greenwich Street
New York 6, New York
DI 9-3143

TERMS: All mdse shipped FOB New York City, prices subject to change without notice. Include 20% deposit for COD's. WRITE TODAY FOR NEW FREE CATALOG!

Make your Math

EASY!

You'll find those time-saving equations easy to use, easy to solve with the aid of

Elements of Mathematics for Radio, TV & Electronics

By Bernhard Fischer & Herbert Jacobs
If you've ever hesitated to use a time-saving equation because you were not quite sure how to set it up; or had moments of doubt about decimals or percentages; or wanted a quick check on your figuring—THIS IS THE BOOK FOR YOU. It makes crystal clear each step in the reasoning and each procedure in the arithmetic, geometry, and algebra needed by radio and TV technicians. You'll find it EASY to work out frequency resolutions, voltage drops, inductive reactances, decibels and the many other radio and TV problems in which accurate use of math is essential. Hundreds of sample problems, with answers, give you thorough practice.

Radio & TV Mathematics

by Bernhard Fischer

A handbook of step-by-step solutions for 409 problems in radio, TV, and industrial electronics. Whatever YOUR problem—whether it is to correct the power factor of a motor, find the impedance and length of a matching stub between antenna and transmission line, or any of hundreds of other problems—here is the clear, exact solution.

Have you got your copy of "The most helpful" service guide?

Mandl's TV Servicing

The book that is eagerly bought by servicemen throughout the country as the most practical and helpful guide to quick, accurate trouble-shooting on today's receivers.

Mandl's TV Service Course Laboratory Manual

46 experiments, with exact what-to-do and what-to-look-for directions, show how each part of a typical receiver operates and what causes trouble.

SEE THEM ON APPROVAL

The Macmillan Co., 60 Fifth Ave., New York 11 G21

Please send me the books checked below. I will remit full price plus small delivery charge, or return books in 10 days. (Save: Send check or money order and we pay delivery charge)

- Elem. of Math. \$7.20
- TV Servicing, \$5.75
- Radio & TV Math. \$6.75
- TV Serv. Lab. Man. \$3.90

Signed _____

Address _____

This offer good only within continental limits of U.S.A.

bilities to include over-all direction of the advertising activities of all consumer product divisions. Morgan Greenwood, newly appointed general advertising manager, will continue to direct all Philco advertising.

... Harold J. Krollman joined Brook Electronics, Inc., Elizabeth, N. J., as production manager of the Linden, N. J., plant. He was previously with Automatic Manufacturing Co. and Federal Telephone & Radio Co.

... Saul Kotchever joined the sales staff of Parkside Wire Co., Chicago.

... Edward Flaxman was appointed sales manager of Waldom Electronics, Chicago. He has been identified with the speaker cone industry for many years.

... Richard McQueen joined National Co., Malden, Mass., as advertising and promotion manager. He was formerly with Magnecord. Elliott H. Ruttenberg, formerly with the Special Products Division of Raytheon, Chicago, joined National as price administrator. John S. Boyers, ex-Magnecord, is now chief engineer of National's Magnetic Memory Devices Division.

... Joseph A. Hatchwell, Mid-Atlantic regional sales manager for Allen B. Du Mont Laboratories' Television Receiver Division, Clifton, N. J., was promoted to director of service.

... Bob Stephens, of Stephens Manufacturing Co., was elected chairman of the Advisory Committee for the 1955 West Coast Audio Fair, to be held at a date and location not yet determined. Membership on the Advisory Committee was increased by the addition of the following members: Gramer Yarbrough, American Microphone Co.; Bert Berlant, Berlant Associates; Bill Thomas, James B. Lansing Sound Co.; Bob Newcomb, Newcomb Audio Products.

... Ralph H. G. Mathews, veteran radio and electronics engineer, joined Magnavox Co., Fort Wayne, Ind., as sales counsel for the High-Fidelity Division. END



STAN-BURN SPARKS

* CATHODE RAY TUBE SPECIALS * ONE YEAR GUARANTEE

G.E.		STAN-BURN	
10BP4A	\$14.95	10BP4	\$10.20
10BP4A	21.10	16JP4 or A	11.97
12KP4A	24.45	12LP4A	13.95
12LP4A	18.75	12QP4	11.90
12QP4A/B1014		16WP4A	17.50
Dumont	21.00	12UP4A	14.50
12UP4B	28.75	14CP4	15.60
14CP4A	24.50	15DP4	17.50
15DP4/B1014		16KP4	17.50
Dumont	23.75	16DP4 or A	17.50
16AP4A	30.95	16JP4 or A	17.50
16DP4A (N.U.)	25.25	16CP4 or A	17.50
16GP4 or B	31.25	16FP4	17.50
16KP4A/B16RP4	24.20	16WP4A	17.50
16KP4A		16AP4	17.50
(Aluminum)	28.35	16AP4A	23.00
16JP4A (N.U.)	25.25	16EP4	19.00
16P4A	28.50	16CP4A	23.50
16WP4A	26.50	16GP4 or A	21.00
16GP4B	31.25	17BP4	18.50
17BP4A	24.25	17CP4A	21.60
17SP4B	30.30	17GP4B	22.60
17CP4A	23.90	19P4	23.00
17CP4B		19FP4A	24.00
(Aluminum)	29.00	19AP4	23.90
19AP4A	41.50	19BP4A	24.90
20CP4	30.00	20CP4A	23.95
20LP4	37.50	21AP4	25.50
21AP4	42.00	21EP4	26.50
21EP4	31.80	24AP4	49.00
21EP4A	36.35		
24AP4	78.50		

QUANTITY CRT USERS
We will give you DUD allowances if you ship them to us Prepaid. 10 CRT's minimum shipment. WRITE FOR DETAILS.

* ANTENNAE SPECIALS *

RED DOUBLE "W" Antenna	1-5	6 or more
10 ELEMENT CONICAL	2.19	1.98
Dowled Inserts	2.98	2.79
Folded Hi-Straight Low Quick Rig		
1/2" elements	4.25	3.25
WINDOW CONICALS	4.95	3.75
5 FOOT SWEGDED	.79	.69
MASTS 10 FOOT PLAIN	1.39	1.29
NECO MASTS	1.49	1.49
TV WIRE		
42 Mil.	\$ 9.95 M FT.	
55 Mil. 300 OHM	11.95 M FT.	
72 OHM COAXIAL	35.00 M FT.	

CHASSIS 630 TECHMASTER Model 1930 with Cascade Tuner \$149.50
OPEN FACE CABINET \$42.00

* TAPE RECORDERS IN STOCK *

PENTRON—Model 9T3C—2-speed Tape Recorder Write for Price.
RADIO CRAFTSMAN Model C400—Hi-Fi Amplifier Net \$42.90
Model C10—AM-FM Tuner Net \$21.50
Model CS00—Williamson Amplifier Net \$9.50

We also carry MASCO—BOGEN—PILOT, etc. Amplifiers—Pre-Amps, FM Tuners and WEBSTER Tape Recorders.
6"x9" PM SPEAKER \$ 3.98
7" PM SPEAKER 3.98
70" Yoke 1.98
630 Vert. Output Upright 1.98
630 Vert. Output Potted 1.29
630 Vert. Blocking Osc. Xform. 1.89
CASCODE TUNERS 14.95
DUMONT 21.25 inc 14.95
Famous INPUTER 10.00
TV Permanent Magnet Focus Assembly 1.98

Three Speed Automatic VM Record Player in portable carrying case. Special \$39.95
20CP4 Progressive Special \$23.95

AUTHORIZED DISTRIBUTORS for: General Electric, Kenrad, Tung-Sol, National Union, De Wald, Regal, Automatic and General Motors.

AUTOMATIC CUSTOM-BUILT RADIOS for Plymouth, Ford, Chevrolet and many others, always in stock. We carry a complete stock of HI-FIDELITY and SOUND EQUIPMENT. Send us your requests. We also carry a complete line of popular makes of Radio tubes at 50/10% discount. Also many other special purpose and transmitting types, and all electronic parts and equipment at lowest prices. Send us a list of your requirements for prompt quotations. Terms: 20% with order. Balance COD. All prices FOB NEW YORK Warehouse. Minimum order \$5.00. Write for our latest Price list and Hi-Fi Catalog to Dept. RE-7.

STAN-BURN RADIO and ELECTRONICS CO. 1697 BROADWAY • NEW YORK 19, N.Y.

\$3.00

FOR CARTOON IDEAS

RADIO-ELECTRONICS prints several radio cartoons every month. Readers are invited to contribute humorous radio ideas which can be used in cartoon form. It is not necessary that you draw a sketch, unless you wish.

Address
**RADIO-CARTOONS,
RADIO-ELECTRONICS**
25 West Broadway, New York 7, N.Y.

BLAK-RAY SELF-FILTERING ULTRA-VIOLET LAMP

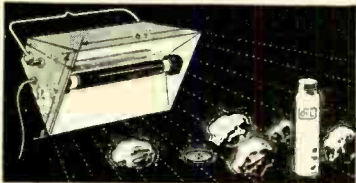

BLAK-RAY 4-watt lamp, model X-4, complete with U-V tube. This lamp gives long-wave ultra-violet radiation having a wave-length of 3654 to 4000 angstrom units. Some of the substances made to fluoresce visibly when illuminated by U-V light are certain woods, oils, minerals, milkstone, cloth, paints, plastics, yarn, drugs, crayons, etc. This lamp is self-filtering and the Invisible U-V rays are harmless to the eyes and skin. Equipped with spectral-finish aluminum reflector. Consumes only 4 watts and can be plugged into any 110 volt 50-60 cycle A.C. outlet. Will give 2000 to 3000 hours of service. It weighs but 1 3/4 lbs. Approved by the Underwriters Laboratories and has a built-in transformer so that it may be safely used for long periods when necessary. Extra U-V tubes are available.

Ship wt. 4 lbs.
ITEM NO. 125
UNUSUAL BUY..... (Shp. Chgs. 70c) **\$16.75**

POWERFUL ALL PURPOSE MOTOR

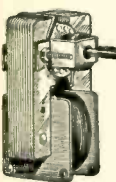

Sturdy shaded pole A.C. induction motor. 15 watts, 3000 rpm. 3"x2"x1 1/4"; 4 mounting studs; 7/8" shaft, 3/16" diameter; 110-120 volts, 50-60 cycles. A.C. only. When geared down, this unit can operate an 18" turntable with a 200 lb. dead weight. Use it for fans, displays, timers and other purposes. Ship wt. 2 lbs.
ITEM NO. 147
UNUSUAL BUY (Shp. Chgs. 35c) **\$2.45**

WATTHOUR METER

Leading makes—reconditioned. Ideal for trailer parks. 100-110 volts, 60 cycles, 2-wire A.C. 5 amp. Heavy metal case 8 1/2" x 6 1/4" x 5". Easy to install. Ship. wt. 14 lbs.

ITEM NO. 33
NOW ONLY **\$4.50**
(Shp. Chgs. \$1.25)

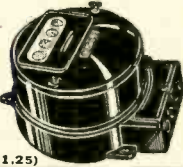

WESTERN ELECTRIC BREAST MIKE

Lightweight 1 lb. carbon microphone. Aircraft type. Breastplate mounting, adjustable 2-way swivel. Easily fastened straps. For home broadcasts, communications etc. Complete with 6 foot cord, hard rubber plug. Sheradized plate, non-rusting finish. Ship. wt. 2 lbs.
ITEM NO. 152
NEW LOW PRICE (Shp. Chgs. 32c) **\$1.98**

AMAZING BLACK LIGHT

250-watt ultra-violet light source. Makes fluorescent articles glow in the dark. Fits any lamp socket. For experimenting, entertaining, unusual lighting effects. Ship. wt. 2 lbs.
ITEM NO. 87
A SAVING AT (Shp. Chgs. 35c) **\$2.45**

250 POWER TELESCOPE LENS KIT

Make your own high powered 6 ft. telescope! Kit contains 2" diam., 75" focal length, ground and polished objective lens and necessary eye pieces. Magnifies 50x to 250x. Full instructions. Ship. wt. 1 lb.
ITEM NO. 123
YOU SAVE AT (Shp. Chgs. 10c) **\$2.95**

HUDSON SPECIALTIES CO.
25 West Broadway, Dept. RE-7-54
New York 7, N. Y.

I am enclosing full remittance for items circled below. (Be sure to include shipping charges.)
OR, my deposit of \$..... Ship balance C.O.D.
MINIMUM C.O.D. ORDER \$5.00.
C.O.D. ORDERS ACCEPTED ONLY WITH 20% DEPOSIT
INCLUDE SHIPPING CHARGES.

Circle Items Wanted
87 147 33 152 125 123

Name Please Print Clearly

Address

City Zone State

ELECTRONIC LITERATURE

Any or all of these catalogs, bulletins, or periodicals are available to you on request direct to the manufacturers, whose addresses are listed at the end of each item. Use your letterhead—do not use postcards. To facilitate identification, mention the issue and page of RADIO-ELECTRONICS on which the item appears. All literature offers void after six months.

CAPACITOR INFORMATION

A comprehensive 48-page catalog issued by Astron Corporation contains—beside complete listings and prices of Astron electrolytic, paper, metalized and special-purpose capacitors—a wealth of technical information on capacitors.

Of the 48 pages, three are devoted to a section of the selection and application of electrolytic capacitors, and an additional page to their performance and test specifications. Engineering and design information on impregnated paper-foil capacitors covers four pages—including characteristics and test specifications on standard and 150°C capacitors. There is also a four-page section of information on metallized paper capacitors, with an additional page of performance characteristics and test specs.

Gratis to service personnel and other interested parties from Astron Corporation, 255 Grant Ave., E. Newark, N.J.

SOUND EQUIPMENT

Leonard Radio Inc., has put out a 16-page catalog on high-fidelity sound equipment. Photos of the equipment appear along with their specifications, description, dimensions, weight, and price.

Available from Leonard Radio Inc., 69 Cortlandt Street, New York 7, N.Y.

SELENIUM RECTIFIER HANDBOOK

Sarkes Tarzian has issued a 3-color 74-page catalog, No. 666.

The catalog is divided into seven sections. Center-sealed power rectifiers, high-voltage selenium rectifiers, embedded selenium rectifiers, and center-cooled radio and television rectifiers are described in detail in the first four sections, along with photographs, schematics, and charts. Many suggestions for applications are given in one section, and a wealth of engineering data in another. The last section contains a revised selenium rectifier replacement guide.

Available from Sarkes Tarzian Inc., Rectifier Division, 415 College Avenue, Bloomington, Ind. Price \$1.00.

COLOR BROADCAST CATALOG

Radio Corporation of America has released a 16-page standard color broadcast equipment catalog, presenting in package form all items required for transmitting network color.

The list includes RCA's color stabilizing amplifier, color monitor, color signal analyzer, linearity checker, color

!! HEARING AID PARTS !!

HEARING AID AMPLIFIER CHASSIS (2 tube) 2"x3"x1 1/2" Ready-wired. MAKE A REAL VEST POCKET RADIO OR AMPLIFIER adding only simple tuner & phone. WITH SCHEMATICS FOR A 2 or 3 TUBE SET. Less tubes & case..... **\$2.49**
SET OF 2 SUB-MINI. TUBES for above..... **\$2.98**
HEARING AID BONE CONDUCTION HEADPHONES (1 1/2"x3 1/4"x1) Makes sensitive MUSICAL CONTACT MIKE, DETECTOPHONE, ETC. Lo-impedance. \$1.98
CRYSTAL PICK-UP MIKE (3/4"x3/4") hi-impedance. Rubber shock-mtd..... **1.29**
MIDGET OUTPUT XFMR (3/4"x1/2"x1/2"). Matches res. voice coil, bone cvrt, or lo-imped. phone..... **49c**
MIDGET AUDIO CHOKE . . . 4500 ohms DC—ea. **49c**
12/55.00
HEARING AID CORD . . . Extremely flexible: black silk over rubber . . . 2 wire (1 1/8" O.D.)—5 ft. 100 ft. **\$3.75**; 3 wire—7 ft., 100 ft. **\$5.75**

!! SCOPE PARTS !!

3" CR TUBE SHIELD, 3BPI. etc.....ea. **\$1.29**
5" CR TUBE FRONT BEZEL..... **98**
5" CR TUBE SPONGE RUBBER FRONT GASKET..... **69**
5" SCOPE VISOR moulded vinyl..... **98**
5 1/4" CLEAR CONVEX LENS round ea. 39c 6/1.98

!! XMAS IN JULY !!

when you get your "JUMBO RADIO, ELECTRONICS KIT" LOAD-UP with new & surplus inventory odds & ends WORTH SEVERAL TIMES THE PRICE! 17 lbs. of SWITCHES, SOCKETS, CONTROLS, WIRE, COILS, TV PARTS & DIAGRAMS, PHOTOFACTS, RESISTORS, CONDENSERS, ETC. (Stamps. wt. 20 lbs.) **\$3.95**

SPECIAL! WOOD CABINET & CHASSIS KIT

Beautiful 1 lb. walnut veneer. Inside: 1 1/2"x7 1/2" H x 6 1/4" D, 4" sq. dial open. on right. PLUS 6 tube punched chassis, perfectly matched-set. **\$1.75**

ATTENTION: SCHOOLS & MFERS. . . . WRITE FOR SPECIAL PRICE ON QUANTITIES.

ASTATIC ALL-CHROME CRYSTAL MIKE

Bullet type, swivel head. 30-10,000 cycle..... **\$7.95**
18 FT. WHIP ANTENNA . . . 6 steel tapered screw sections. **\$3.75**. Extra extension sects. ea. 75c
RADIO HARDWARE TREASURE . . . FULL LB. CAN of Nuts, Screws, Washers, Lugs, etc.—ea. **89c**
3 lbs. **\$2.49**

ECLIPSE REVERSIBLE MOTOR (Type Y-150, #BJ-8143) Approx. 1 1/2 H.P. 3800 RPM, 24VDC. Splined 1 1/2" shaft, 6" L x 4" O.D. Ship. wt. 11 lbs. BRAND NEW—WHILE THEY LAST! **\$6.95**

"DIRECT FACTORY SPEAKER REPAIRS SINCE 1927"
Min. Order \$3.00. 20% deposit req. on all C.O.D.'s. please add sufficient postage—excess refunded

LEOTONE RADIO CORP.
67 Day Street
New York 7, N. Y.

URGENT! URGENT! ELECTRONIC TUBES

We Pay Spot Cash for:

RADIO, TV all types

State types, condition of merchandise, quantities and price

COLUMBIA ELECTRONICS CORP.

115 Liberty Street, N. Y. C.

RADIO-ELECTRONICS is paying good rates on acceptance for original and unusual articles on audio, television, FM and AM servicing, as well as articles on industrial electronic equipment and applications. Send for a copy of our Authors' Guide. Address:

**THE EDITOR
RADIO-ELECTRONICS**

25 West Broadway,
New York 7, N. Y.



TERRIFIC TUBE VALUES!

TOP QUALITY FULLY GUARANTEED TUBES BELOW MFRS' PRICES

THIS MONTH'S SPECIALS

We specialize in TUBES—Receiving, transmitting and special purpose, etc.—serving the industry for years. More than 3000 different types in stock for IMMEDIATE DELIVERY—including hard-to-get and discontinued numbers. All tubes exhaustively tested in our fully equipped laboratories, and re-tested at time of shipment. FULL ONE-YEAR GUARANTEE. All tubes individually boxed and code-dated.

Our new policy brings you greater tube savings than you thought possible! As a GOODWILL offering, we are giving, each month, a number of popular tube types (listed below in extra bold) AT PRICES BELOW OUR OWN COST! Look for these terrific offers of different types each month. In industry-wide publications!

Type	Price	Type	Price	Type	Price	Type	Price	Type	Price	Type	Price	Type	Price	Type	Price
0A2	.89	3A8	.60	6F8G	.69										
0A3 VRT5	.99	3B7	.39	6GG	.65										
0A4G	.65	3D6	.39	6H6	.49										
0B2	.74	3LF4	.79	6J5	.49	Type <th>Price</th> <td></td> <td></td> <td></td> <td></td> <td></td> <td></td> <td></td> <td></td>	Price								
0B3 VRI90	.98	3Q5GT	.55	6J7	.49	7B5	.59	12H6	.45	35Y4	.45				
0C3 VRI105	.98	3S4	.50	6K7	.49	7B6	.59	12J5GT	.39	35Z3	.43				
0D3 VRI150	.89	3T4	.50	6K8G	.65	7B7	.59	12J7GT	.58	35Z5GT	.48				
0Z4	.54	5T4	1.28	6L7	.39	7C4	.58	12K7	.42	42	.41	J2J6	26.95		
1A5GT	.43	5U4G	.53	6L7G	.39			12K8	.58	43	.55	3C24	1.75		
1A7	.49	5Y3GT	.38	6N7	.39			12Q7GT	.59	45Z3	.49	304TL	7.50		
1AB5	.39			6P7	.65			12S6GT	.61	47	.89	307A	4.80		
1AX2	.55	5Z3	.33	6Q7	.49	7C5	.49	12S7GT	.64	49	.44	315A	3.50		
1B3	.69	6A6	.47	6R7	.77	7C7	.65	12T5GT	.69	49	.44	326A	2.50		
1D8GT	.77	6A7	.69	6Q7	.49	7F7	.65	12T7GT	.69	49	.44	330A	2.50		
1G6GT	.59	6AR	.69	6Q7	.49	7H7	.59	12U5GT	.69	49	.44	340A	2.50		
1H5GT	.43	6AR4	.79	6S4	.42	7J7	.59	12V5GT	.75	59	.58	345A	2.50		
1J6G	.59	6AH6	.89	6S7G	.59	7L7	.59	12W5GT	.75	59	.58	350A	2.50		
1L4	.59	6AC5GT	.99	6S7G	.59	7M7	.59	12X5GT	.75	59	.58	355A	2.50		
1LA4	.59	6AC7	.69	6S7G	.59	7N7	.59	12Y5GT	.75	59	.58	360A	2.50		
1LA6	.79	6AF4	.89	6S7G	.59	7P7	.59	12Z5GT	.75	59	.58	365A	2.50		
1LB4	.79	6AT6	.37	6S7G	.59	7Q7	.59	12Z5GT	.75	59	.58	370A	2.50		
1LC5	.59	6AV5	.79	6S7G	.59	7R7	.59	12Z5GT	.75	59	.58	375A	2.50		
1LC6	.79	6AV5	.79	6S7G	.59	7T7	.59	12Z5GT	.75	59	.58	380A	2.50		
1LD5	.59	6AV5	.79	6S7G	.59	7U7	.59	12Z5GT	.75	59	.58	385A	2.50		
1LE3	.59	6AX4GT	.57	6S7G	.59	7V7	.59	12Z5GT	.75	59	.58	390A	2.50		
1LG5	.77	6B7	.95	6S7G	.59	7W7	.59	12Z5GT	.75	59	.58	395A	2.50		
1LH4	.78	6AK5	.49	6S7G	.59	7X7	.59	12Z5GT	.75	59	.58	400A	2.50		
1LN5	.57	6AL5	.30	6S7G	.59	7Y7	.59	12Z5GT	.75	59	.58	405A	2.50		
1NS	.61	6AQS	.41	6S7G	.59	7Z7	.59	12Z5GT	.75	59	.58	410A	2.50		
1PSGT	.57	6AUS	.43	6S7G	.59	10Y	.69	12Z5GT	.75	59	.58	415A	2.50		
1QSGT	.57	6AVS	.79	6S7G	.59	12AH7	.89	12A7	.68	14F7	.59	81	1.11	801A	3.30
1R5	.49	6AUS	.43	6S7G	.59	12AT6	.39	12AU6	.39	14G7	.67	85	.59	801A	3.30
1S4	.58	6AVS	.79	6S7G	.59	12A7	.68	12AU6	.39	14H7	.59	85	.59	801A	3.30
1S5	.43	6AVS	.79	6S7G	.59	12A7	.68	12AU6	.39	14I7	.59	85	.59	801A	3.30
1S6A	.48	6AVS	.79	6S7G	.59	12A7	.68	12AU6	.39	14J7	.59	85	.59	801A	3.30
1T4	.48	6AX4GT	.57	6S7G	.59	12A7	.68	12AU6	.39	14K7	.59	85	.59	801A	3.30
1U5	.48	6B7	.95	6S7G	.59	12A7	.68	12AU6	.39	14L7	.59	85	.59	801A	3.30
1X2A	.55	6B8G	.29	6S7G	.59	12A7	.68	12AU6	.39	14M7	.59	85	.59	801A	3.30
2A3	.95	6BA6	.42	6S7G	.59	12A7	.68	12AU6	.39	14N7	.59	85	.59	801A	3.30
2A6	.62	6BA7	.56	6S7G	.59	12A7	.68	12AU6	.39	14O7	.59	85	.59	801A	3.30
2A7	.64	6BC5	.48	6S7G	.59	12A7	.68	12AU6	.39	14P7	.59	85	.59	801A	3.30
2B7	.62	6BD6	.44	6S7G	.59	12A7	.68	12AU6	.39	14Q7	.59	85	.59	801A	3.30
2K2	.62	6BE6	.39	6S7G	.59	12A7	.68	12AU6	.39	14R7	.59	85	.59	801A	3.30
2X2A	1.15	6BE6	.39	6S7G	.59	12A7	.68	12AU6	.39	14S7	.59	85	.59	801A	3.30
3A4	.44	6BE6	.39	6S7G	.59	12A7	.68	12AU6	.39	14T7	.59	85	.59	801A	3.30
3A5	.93	6BE6	.39	6S7G	.59	12A7	.68	12AU6	.39	14U7	.59	85	.59	801A	3.30

FREE OFFER!
Seven Assorted 12, 7, 6, 1 and 2-volt type tubes. List Value approx. \$23. FREE with every order for \$25 or more!

6BZ7 .79
6C5 .39
6C6 .57
6C8 .85
6CB6 .45
6CDB .10
6D6 .98
6D8 .98
6F6 .45
6F7 .93

STANDARD BOOSTER, lots of 3, each...\$6.58
Single lots, each \$6.96
TRACTOR RADIO, List \$99.75, net each...\$29.77
HEADSETS, PAIR, lots of 3, each...\$2.56
See June Issues of Radio News and Radio-Electronics for complete descriptions.
Minimum Order \$10. Please include 25% deposit with order. Prices subject to change without notice. All prices F.O.B. our warehouse, N.Y.C.
WRITE FOR TYPES NOT LISTED

ELECTRON TUBE WHOLESALERS, INC.
140 DUANE STREET • NEW YORK 13, N. Y. • Phone: BR 4-7616

NEW LISTING!
Just out—all popular tube types, at lowest wholesale prices!
Send today for your FREE Copy!

5BP1 3.55
5BP4 5.95
5BP5 7.45
12DP7 19.50
16HP4A 18.95
16DP4 18.95
INDUSTRIAL
Type Price
1822 1.80
1824 5.89
1832 1.90
1N23 1.95
2C26A .59

OPPORTUNITY ADLETS
Rates—45c per word (including name, address and initials). Minimum ad 10 words. Cash must accompany all ads except those placed by accredited agencies. Discount, 10% for 12 consecutive issues. Misleading or objectionable ads not accepted. Copy for Sept. issue must reach us before June 16, 1954.
Radio Electronics, 25 W. Broadway, New York 7, N. Y.

SPEAKER REPAIRS ON ALL MAKES. Jobbers wanted. Amprite Speaker Service, 70 Vesey St., New York 7, N. Y.

REPAIR ON ALL MAKES of test equipment, and kit construction, starting September First. Write now for free information. Bigelow Electronics, Pioneer Road, Beulah, Michigan.

DIAGRAMS FOR REPAIRING RADIOS \$1.00. Record Changers \$1.50. Television \$2.00. Give Make, Model. Diagram Service, 672-RE, Hartford 1, Conn.

TEST EQUIPMENT Repaired and Calibrated by Factory staff. All makes. Superior, Simpson, Triplet, Heath, etc. Immediate service. Douglas Instrument Laboratory, 176a Norfolk Avenue, Boston 19, Mass.

TUBES—TV, RADIO, TRANSMITTING, AND SPECIAL PURPOSE TYPES BOUGHT, SOLD AND EXCHANGED. Send details to B. N. Gensler W2JN1, 136 Liberty, N. Y. 6, N. Y.

ALL MAKES OF ELECTRICAL INSTRUMENTS AND TESTING equipment repaired. Write for free catalogue on new and used instruments at a savings. Hazleton Instrument Co., 128 Liberty Street, New York, N. Y.

BUILD YOUR OWN ELECTRONIC ORGAN, OR MINATURE electronic brain. Jim Kirk, W6JKX, 1552 Church Street, San Francisco 14, California.

24-PAGE PLANS "I-Tube Receiver" (Record 12,000 miles) with 6 issues "Radiobuilder" \$1.00. Laboratories, 328-B Fuller, Redwood City, California.

WANTED: AN/APR-4, other "APR", "TS-", "TE-", ARC-1, ARC-3, ART-13, RC-348, etc. Microwave Equipment. Everything Surplus. Special tubes. Tee Manuals, Lab Quality Equipment, Meters. Fast Action, Fair Treatment. Top Dollar! Littell, Fairhills Box 26, Dayton 9, Ohio.

ALUMINUM TUBING, Angle and Channel. Plain and Perforated Sheet. Willard Radcliff, Fostoria, Ohio.

TELEVISION RECEIVERS \$30 UP. W4API, 1420 South Randolph, Arlington 4, Virginia.

BASS-REFLEX ENCLOSURES \$19.95 up. Buy Direct. Send for Literature. Velvet-Voice Enclosures, Box 472, Fontana, California.

TV FM ANTENNAS, ALL TYPES INCLUDING UHF. Mounts, accessories. Lowest prices. Wholesale Supply Co., Luneburg 2, Mass.

monitor analyzer, burst-controlled oscillator, color frequency standard, burst flag generator, color bar generator, and color plexer.
Available to interested parties from Radio Corporation of America, Broadcast Equipment Section, Engineering Products Department, Camden, N.J.

WIRE AND CABLE FOR SOUND
Alpha Wire's wire and cable for sound catalog 153-S comprises eight pages. It features a new way in which to illustrate each type of wire and cable so that the reader can clearly understand its construction and application. Each wire and cable is "stripped back" and its constituent conductors and insulation clearly marked. Integrated with these "anatomic" photos are construction specifications arranged in easy-to-read tables and in brief, clear textual descriptions. The general purpose of each type is also carefully detailed.

To help the reader find the wire or cable he needs as quickly as possible, three fast-reference charts are included in the catalog. These are: descriptive index, numerical index, and the Alpha E-Z identification chart (which cross-references construction data with Alpha catalog numbers).
Gratis from Alpha Wire, 430 Broadway, New York 13, N.Y.

VOLTMETER
Charles Engelhard, Inc., has issued a 4-page booklet introducing the new Hermach-Engelhard transfer voltmeter, an instrument with an accuracy of 0.05% from 20 to 20,000 cycles. It lists all the features that the a.c. voltmeter offers.
Available upon request to Charles Engelhard, Inc., 850 Passaic Avenue, East Newark, N.J.

TIME DELAY GENERATOR
Rutherford Electronics Co. has prepared a 2-page brochure on the Model A-5 time-delay generator. It describes in detail all the electrical and physical characteristics of the unit. In addition, it outlines some of the possible uses of the instrument as well as its special features.
Available free from Rutherford Electronics, 3707 South Robertson Blvd., Culver City, Calif. END



"Well, either super circus has pink elephants or my chroma's on the bum!"

RADIO SCHOOL DIRECTORY

TELEVISION

PREPARE FOR A GOOD JOB!
BROADCAST ENGINEER
ELECTRONICS
RADIO SERVICING

Television Servicing

(Approved for Veterans)
SEND FOR FREE LITERATURE
BALTIMORE TECHNICAL INSTITUTE
1425 EUTAW PLACE, BALTIMORE 17, MD.

Get Your F.C.C. LICENSE Quickly!

Correspondence or residence preparation for F.C.C. examinations. Results guaranteed.

An FCC commercial operator license means greater opportunities and higher pay. We are specialists in preparing you, in a MINIMUM OF TIME, to pass FCC examinations for all classes of licenses. Beginners get 2nd class license in 5 weeks and 1st class in 3 additional weeks. Write for free booklet.

GRANTHAM School of Electronics
Dept. 101, 6064 Hollywood Blvd., Hollywood 28, Calif.

CODE SENDING RECEIVING SPEED

Be a "key" man. Learn how to send and receive messages in code by telegraph and radio. Commerce needs thousands of men for jobs. Good pay, adventure, interesting work. Learn at home quickly through famous Candler System. Qualify for Amateur or Commercial License. Write for FREE BOOK.

CANDLER SYSTEM CO.
Dept. 3-11, Box 928, Denver 1, Colo., U.S.A.

RCA INSTITUTES, INC.
A service of Radio Corporation of America
350 West 4th St., New York 14, N. Y.

OFFERS COURSES IN ALL TECHNICAL PHASES OF RADIO, TELEVISION, ELECTRONICS
Approved for Veterans
Write Dept. RC-54 for Catalog

RADIO ENGINEERING DEGREE IN 27 MONTHS

Intensive, specialized course including strong basis in mathematics and electrical engineering, advanced radio theory and design, television. Modern lab. Low tuition. Self-help opportunities. Also B.S. degree in 27 months in Aeronautical, Chemical, Civil, Electrical, and Mechanical Engineering. G.I. Gov't approved. Enter September, December, March, June. Catalog.

INDIANA TECHNICAL COLLEGE
1574 E. Washington Blvd., Fort Wayne 2, Indiana

MORE JOBS

than graduates

Demand for our engineering graduates exceeds supply. *Effective placement.* Study in this world-famed college established 1884. Quarters start June, Sept., Jan., March. Approved for Korean Vets.

Bach. Sc. degree in 27 months

Complete Radio Eng. courses... TV, UHF and FM. Also Mech., Civil, Elec., Chem., Aero. and Adm. Eng.; Bus. Adm., Acct. Small classes. Well-equipped labs. Modest costs. Prep. courses. Write *Jean McCarthy, Director of Admissions,* for Catalog and Campus View Book.



TRI-STATE COLLEGE

2474 College Avenue, Angola, Indiana

GET INTO ELECTRONICS

You can enter this uncrowded, interesting field. Defense expansion, new developments demand trained specialists. Study all phases radio & electronics theory and practice: TV; FM; broadcasting; servicing; aviation, marine, police radio. 18-month course. Graduates in demand by major companies. H.S. or equivalent required. Begin Jan., March, June, Sept. Campus life. Write for catalog.

VALPARAISO TECHNICAL INSTITUTE
Dept. C Valparaiso, Ind.



TV REPAIRMEN MAKE TOP MONEY

In just 39 weeks, you can get complete TV service training! Streamlined course gives you all essentials for a good job as service technician. Graduates in great demand; jobs are plentiful in this growing field. Other courses, in electronics, radio operation and maintenance. Day or evening classes; modern equipment. Opportunity for employment in local industry.

Write for Catalog 111 Today
INDIANAPOLIS ELECTRONIC SCHOOL
312 E. Washington, Indianapolis 4, Ind.

LEARN TV SERVICING

Send for free 24-page illustrated booklet which tells you how to become a successful TV technician. America's leading TV servicing school offers you a specialized training program that omits non-essential math & design theory. You concentrate on radio & TV servicing only. You get professional training & experience right in our fully-equipped shops & laboratories. Write Dept. E-74

Approved for Veterans
WESTERN TELEVISION INSTITUTE
341 W. 18th St. Los Angeles 15, Calif.

SUBSCRIBERS

If you're moving, please don't forget to send us your address as it appears on the copy of the magazine, including the numbers shown beside your name, as well as your new address.

If we receive this information before the 20th of the month, you will continue getting the magazine without interruption. Your cooperation will be most helpful and greatly appreciated.

You Can Become an ELECTRICAL ENGINEER with a Bachelor of Science Degree IN 36 MONTHS

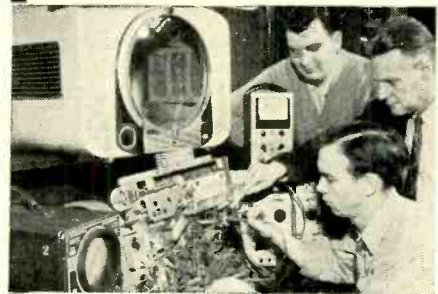

Major in Electronics or Power at Milwaukee School of Engineering

Everyone knows the tremendous opportunities ahead in electrical engineering. The expanding field of color television alone is one example. In addition to the demand for engineers, thousands of engineering technicians are needed. The Milwaukee School of Engineering can prepare you to become an engineer in 36 months or an engineering technician in 12 to 18 months. It'll pay you to look into it today. No obligation.

Technician and Service Courses — 12 to 18 months

In 12 months you can be a radio technician. An additional 6-month course qualifies you as a radio-television technician with an Associate in Applied Science degree. Or you can earn an industrial electronic technician certificate in 12 months.

These technician courses form the first third of the program leading to a B.S. Degree in Electrical Engineering. Twenty-one subjects in electronics, electronic engineering, and electronic design in this course.

Also offered are: radio-television service course (12 mos.); electrical service course (6 mos.); general preparatory and refresher course (3 mos.).



Terms open
July, September,
January and April

Faculty of specialists — 50,000 former students — Annual enrollment from 48 states and 23 foreign countries — Non-profit institution — 51st year of service — Course approved for veterans — Residence courses only.

MILWAUKEE SCHOOL OF ENGINEERING

TEAR OUT AND MAIL TODAY
MILWAUKEE SCHOOL OF ENGINEERING
Dept. RE-754, 1025 N. Milwaukee Street
Milwaukee 1, Wisconsin

Send me Free illustrated booklet on opportunities in Electrical Engineering or Free illustrated booklet on careers in Radio-TV.

I am interested in _____ (name of course)

Name _____ Age _____

Address _____

City _____ Zone _____ State _____

If veteran, indicate date of discharge _____

first flight



Without trust in Daddy's strong arms, fear would blot out the fun of first flight. But because Daddy's smiling, loving face is below, life adds a thrilling new dimension, founded in love and trust.

All our adventures begin in and come home to the security we cannot do without.

To give and to get security is the main business of living. It is a privilege and a responsibility. It provides us life's finest rewards.

Have you ever thought that this security is possible only in a democracy? We continue to grow stronger as a nation when more and more secure homes are bulwarked together. The security of your country depends on your security.

Saving for security is easy! Here's a savings system that really works—the Payroll Savings Plan for investing in United States Savings Bonds.

Go to your company's pay office, choose the amount you want to save. That money will be set aside for you before you even draw your pay. And invested in Bonds which are turned over to you.

If you can save only \$3.75 a week on the Plan, in 9 years and 8 months you will have \$2,137.30.

U.S. Series "E" Savings Bonds earn interest at an average of 3% per year, compounded semiannually, when held to maturity! And they can go on earning interest for as long as 19 years and 8 months if you wish, giving you back 80% more than you put in!

For your sake, and your family's, too, how about signing up today? Or join the Bond-A-Month Plan where you bank.

The U. S. Government does not pay for this advertisement. It is donated by this publication in cooperation with the Advertising Council and the Magazine Publishers of America.



BOOK REVIEWS

SPECIALIZED HOME AND PORTABLE RADIO MANUAL, Volume 8 (RCA). Published by John F. Rider Publisher, Inc., 480 Canal Street, New York 13, N. Y. 8½ x 11 inches, 96 pages. Price \$1.65.

This is the eighth in a series of 11 volumes of diagrams and servicing information covering 49 different home and portable radio manufacturers. The manufacturers are grouped alphabetically through the 11 volumes.

Volume 8 covers RCA home and portable receivers released between June, 1951, and December, 1953. Thirty-four of the 96 pages contain schematic diagrams; the remaining pages carry tube-socket voltage and alignment tables, dial-stringing and service-adjustment diagrams, parts lists, and other pertinent servicing data.

This book presents in a compact, convenient, and inexpensive form, all the material found on pages 1 through 96 of the RCA section of Volume 23 of Rider's *Perpetual Troubleshooter's Manual*.—RFS

AUTOMATIC RECORD CHANGER SERVICE MANUAL, Volume 5 (1952-1953) including Multispeed Changers and Tape Recorders. Compiled and published by Howard W. Sams & Co., 2205 E. 46th Street, Indianapolis 5, Ind. 8½ x 11 inches, pages not numbered. Price \$3.00.

Like the previous volumes of this series, this is a compilation of Photofact folders covering the various makes and models of record changers and tape recorders. A comparison of this volume with the preceding one points up very dramatically the growth and acceptance of tape recorders.

Of the 22 folders in this volume, only six are needed to cover 17 different changer models produced by 5 manufacturers, and 16 cover approximately 57 tape recorder models of 11 different makes. (The previous volume of 26 folders covered 16 changer models, 14 tape and 6 wire recorders, and one combination disc and tape recorder.)

A two-part 14-page index is included in the book. The first section lists all makes and models of record changers and recorders covered in Volumes 1 through 5. The second section is a cross-index showing the make and model number of the record changer used in various radio and TV receiver combinations produced since 1947.—RFS

Color TV

By Jeanne DeGood

The jobs and pay in this TV
Are better than the duller
kind,
And quite an opportunity—
Unless a man is color-blind.

SERVICING TV VERTICAL and HORIZONTAL OUTPUT SYSTEMS, by Harry E. Thomas. Published by John F. Rider Publisher, Inc., 480 Canal Street, New York 13, N. Y. 5¼ x 8¼ inches, 172 pages. Price \$2.40.

Displaying painstaking attention to details, the author has given a complete analysis of the television "workhorse" circuits, the vertical and horizontal output systems.

Using easily understood, straight-from-the-shoulder theory, he treats exhaustively the development of the vertical and horizontal waveshapes as they are formed in their respective output circuits and appear in the deflection yokes. The horizontal output circuit being the more complex and of the greater interest to the service technician, is treated at great length. The author discusses the output tube, output transformer, linearity and width coils, damper diode, deflection yokes, and high-voltage circuit individually and collectively.

Separate chapters are devoted to variations in horizontal and vertical sweep output systems, the deflection yoke, and mechanical features of sweep-circuit components.

As a conclusion to the book, the final chapter consolidates the previously covered theory in a thorough discussion of waveforms and picture-tube patterns caused by defective output circuits.

For fulfilling a designated purpose, the author has scored a bull's-eye.—JK

THE PRESENT STATE OF PHYSICS, arranged by Frederick S. Brackett. Published by the American Association for the Advancement of Science, 1515 Massachusetts Ave., N.W., Washington 5, D. C. 6½ x 9 inches, 265 pages. Price \$6.75.

This is a collection of papers on nuclear physics, solid-state electronics, chemical physics, and biophysics. The book is intended for scientists, and the language of much of it is at the scientist's level. However, electronic technicians will be particularly interested in three of the papers: "The New Electronics" (Lark-Horowitz), "Flow of Electrons in Holes and Semiconductors" (Gardeen), and "Barium Titanate Ferroelectrics" (von Hippel). They will find all three both understandable and informative.—FS

COLOR TV CIRCUITS and SERVICING, by Charles C. Beste and Frederick J. Beste, Jr. Published by Beste Electronic Engineering Co., Baltimore, Md. 6 x 9 inches, 104 pages. Price \$2.95.

This book is suitable for those who wish to get a quick smattering of color TV, or for those who have heard of color TV and have a mild, not insatiable, urge to learn more about it. Within its six chapters the authors discuss fundamentals of color television, reproduction of color TV images, NTSC color system, color receiver circuits, color TV servicing, and a glossary of color terms.

While this book is by no means complete, it can act as an introduction to a more comprehensive text.—MC END

Here's a NEW Way to Reach the Top in TV SERVICING

**All-practice method—
professional techniques,
skills, knowledge of
circuits, etc.**



Includes 17" picture tube, all other tubes, components for a TV Receiver, Scope, Signal Generator, HF Probe. Low Introductory price under \$200, on easy terms. Mail Coupon today.

IF YOU HAVE some Radio or Television experience, or if you know basic Radio-Television principles but lack experience—NRI's new Professional Television Servicing course can train you to go places in TV servicing. This advertisement is your personal invitation to get a free copy of our booklet which describes this training in detail.

LEARN-BY-DOING "ALL THE WAY"

This is 100% learn-by-doing, practical training. We supply *all* the components, *all* tubes, including a 17-inch picture tube, and comprehensive manuals covering a thoroughly planned program of practice. You learn how experts diagnose TV receiver defects quickly. You see how various defects affect the performance of a TV receiver—picture and sound; learn to know the causes of defects, accurately, easily, and how to fix them. You do more than just build circuits. You get practice recognizing, isolating, and fixing innumerable TV receiver troubles.

You get actual experience aligning TV receivers, diagnosing the causes of complaints from scope patterns, eliminating interference, using germanium crystals to rectify the TV picture signal, obtaining maximum brightness and definition by properly adjusting the ion trap and centering magnets, etc. There isn't room on this or even several pages of this magazine to list all the servicing experience you get.

UHF AND COLOR TV MAKING NEW BOOM

Installing front-end channel selector strips in modern UHF-VHF Television receivers and learning UHF servicing problems and their solution is part of the practice you get if you live in a UHF area. To cash in on the coming color TV boom you'll need the kind of knowledge and experience which this training gives.

GET DETAILS OF NEW COURSE FREE

Once again—if you want to go places in TV servicing, we invite you to find out what you get, what you practice, what you learn from NRI's new course in Professional Television Servicing. See pictures of equipment supplied, read what you practice. Judge for yourself whether this training will further your ambition to reach the top in TV servicing. We believe it will. We believe many of tomorrow's top TV servicemen will be graduates of this training. Mailing the coupon involves no obligation.



**National Radio Institute, Dept. 4GFT
16th and U Sts., N.W., Washington 9, D. C.**

Please send my FREE copy of "How to Reach the Top in TV Servicing." I understand no salesman will call.

Name _____ Age _____

Address _____

City _____ Zone _____ State _____

SAVE 2-WAYS WITH UNIVERSITY DRIVER UNITS & TRUMPETS

1. Higher Conversion Efficiency Lowers Amplifier Costs
2. Highest Quality Eliminates Maintenance Expense

RUGGEDIZED TRUMPETS



UNIVERSITY trumpets are built to the highest standards in the industry—by the pioneers of the reflex trumpet. They are completely weather-proof, super conditioned for any locale or climate. Achievement of highest attainable conversion efficiencies reduce amplifier requirements. Get the facts.

* Less Driver Unit

MODEL	GH	LH	PH	SMM
Low Frequency Cutoff	85 cps.	120 cps.	150 cps.	200 cps.
Sound Distribution	65°	75°	85°	95°
Air Column Length	6 1/2 ft.	4 1/2 ft.	3 1/2 ft.	2 1/2 ft.
Bell Diameter	30 3/8"	25 3/8"	20 1/4"	16 1/4"
*Horn Length	27 7/8"	19"	15 3/4"	12"
*Shipping Weight	25 lbs.	20 lbs.	11 lbs.	9 lbs.

HIGH EFFICIENCY DRIVER UNITS



MODEL SA-HF — Workhorse of the sound industry for general PA and Industrial use. Very high efficiency delivers extra punch to cut through heavy noise. Response to 10,000 cps. —ideal for both speech and music. Tropically and hermetically sealed for trouble-free service anywhere.

MODEL MA-25 — A low cost unit for use where response to 6000 cps. meets requirements. No compromise in quality — incorporates all the famous UNIVERSITY quality features — high efficiency magnet structure, tropically full size 2" voice coil, rim-centered break-down proof bakelite diaphragm, etc.



MODEL PA-30 — A "de-luxe" unit incorporating every advance design feature including famous University W Alnico 5 Magnet and built-in transformer with terminals available thru housing base. For all amplifiers including 70 volt systems. Response 80-10,000 cps. with 30 watt cont. power.

MODEL SA-30 — Similar to the SA-HF in response and efficiency but includes a multi-impedance line matching transformer with taps accessible through water-tight cover. Taps designated in impedance values and watts for "constant voltage" lines. Die-cast aluminum housing offers lasting protection.



Write for catalog describing the complete line of University Hi-Fi and PA reproducer equipment, including Radial Type Projectors. Address Desk 16-G

University LOUDSPEAKERS INC

80 SO. KENSICO AVE., WHITE PLAINS, N. Y.

ADVERTISING INDEX

Radio-Electronics does not assume responsibility for any errors appearing in the index below.

All Channel Antenna Corp.....	98
Allied Radio Corp.....	15
American Phenolic Corp.....	100
American Television and Radio Co.....	71
Amplifier Corporation of America.....	117
Arky Radio Kits, Inc.....	118
Astatic Corp.....	18
Astron Corp.....	22
Atlas Sound Corp.....	108
Audel Publishers.....	117
Barry Electronics Corp.....	128
Bell Telephone Labs.....	26
Brooks Radio & TV Corp.....	106
CBS Hytron (Div. of Columbia Broadcasting System).....	10
Capitol Radio Engineering Institute.....	23
Centralab—Division of Globe Union.....	21
Century Electronics Co.....	119
Changul Master Corp.....	127
Chicago Standard Transformer Corp.....	80
Cleveland Institute of Radio-Electronics.....	9
Collins Audio Products Co., Inc.....	76
Columbia Electronics Corp.....	123
Columbia Wire & Supply Co.....	20
Concord Radio.....	88
Cornell-Dubilier Electric Corp.....	109
Coyne Electrical & TV Radio School.....	85
Delco Radio (Division of General Motors Corp.).....	101
Desco Mfg. Co.....	8
DeVry Technical Institute.....	77
Dumont Labs., Allen B.....	Inside Front Cover
Edlie Electronics.....	121
Electric Sprocket Service Co.....	120
Electro-Voice, Inc.....	Inside Back Cover
Electron Tube Wholesalers, Inc.....	124
Electronic Instrument Co., Inc. (EICO).....	28, 119, 120
Electronic Measurements Corp.....	107
Fenton Co.....	114
General Cement Mfg. Co.....	103
General Instrument & Appliance Corp.....	97
General Test Equipment.....	102
Heath Co.....	65-68
Hershel Radio Co.....	98
Hudson Specialties Co.....	123
Hughes Research & Development Labs.....	95
Indiana Technical College.....	119
Instructorgraph Co.....	114
International Correspondence Schools.....	13
International Rectifier Corp.....	79
Jensen Industries.....	113
Leotone Radio Corp.....	123
Mallory & Co., Inc., P. R.....	91
McGraw-Hill Book Co.....	81
Macmillan Co., The.....	122
Metalace Corp.....	118
Moss Electronic Distributing Co.....	72, 73
Moseley Electronics.....	102
Musical Masterpiece Society.....	90
National Electronics of Cleveland.....	112
National Radio Institute.....	3, 127
National Schools.....	5
New Jersey Television Supply Co.....	90
Parma-Power Co.....	115
Precision Development Corp.....	112, 113
Precision Apparatus Co., Inc.....	94
Precision Electronics.....	108
Prentice-Hall, Inc.....	78
Progressive "Edu-Kits", Inc.....	105
Quam Nichols, Inc.....	118
RCA Institutes, Inc.....	11
RCA Victor Div. (Radio Corp. of America) 25, Back Cover	
Rad-Tel Tube Co.....	129
Radelco Manufacturing Co.....	92
Radiart Corp.....	6
Radio City Products.....	102

RADIO SCHOOL DIRECTORY PAGE 125

Baltimore Technical Institute	
Candler System Co.	
Grantham School of Electronics	
Indiana Technical College	
Indianapolis Electronic School	
Milwaukee School of Engineering	
RCA Institutes, Inc.	
Tri-State College	
Valparaiso Technical Institute	
Western Television Institute	
Radio-Television Training Association.....	17
Raytheon Manufacturing Co.....	8
Rek-O-Kut Co.....	94
Rider, Inc., John F.....	92
Rinehart & Co., Inc.....	114, 119
Rohn Manufacturing Co.....	120
Sams & Co., Inc., Howard W.....	16
Sangamo Electric Co.....	114
Service Instruments Co.....	20
Shure Brothers, Inc.....	89
Sprague Products Co.....	63
Sprayberry Academy of Radio.....	122
Stan-Burn Radio & Electronics.....	92
Steve-El Electronics Corp.....	85
Stuart Electronic Distributing Co.....	19
Sylvania Electric Products.....	130
Tab.....	24
Technical Appliance Corp.....	80
Television Communications Institute.....	117
Teltron Electric Co.....	14
Tung-Sol Electric Co.....	128
University Loud Speakers.....	110
Video Electric Co.....	99
Walisco Electronics Corp.....	83
Winsor Electronic Tube Co.....	12
Winegard Co.....	120
Zingo Products.....	120

DIAMONDS OR RHINESTONES?

How many times have you been fooled by cheap, imitation jewelry (or tubes) that looked like the "real" thing?

Too often cheap prices and extravagant claims have fooled the buyer into purchasing these imitations, instead of the genuine article.

Barry Electronics sells first quality, fully guaranteed, individually boxed, STANDARD-BRAND Tubes. Our Tubes do not have to be "set or meter checked". They are from original, sealed cartons from the five leading Tube manufacturers.

Cheap imitations such as seconds, rewashed barrels, and off-brands result in unnecessary call-backs, expenses, and loss of customer good-will.

You can place your confidence in our new, first quality, fully-guaranteed STANDARD-BRAND Tubes.

Ask for FREE News Bulletin and Handy Order Form

Tube Orders Over \$25.00, with full remittance, PREPAID to you in U.S.A.

RECEIVING TUBES

Type	Net	Type	Net	Type	Net	
0A2	.95	6AX5GT	1.25	758	.78	
0B2	.85	6BA6	.75	7C4	.29	
0B3/VR90	.82	6B8G	.70	7CS	.69	
0C3/VR105	.91	6BC5	.74	7ES	.85	
0D3/VR150	.89	6BE6	.85	7F7	.70	
0Z4/OZ4A	.55	6BF5	.94	7F8G	1.55	
1A7GT	.77	6BG6G	1.89	7H7	.95	
1B4	.87	6BJ6	.85	7J7	.98	
1B27	11.50	6BK6	.85	7K7	.98	
1H5GT	.77	6BK5	.95	7X7	.90	
1L6	.95	6BK7A	1.15	12AT6	.55	
1L6A	1.10	6BL7GT	1.20	12AT7	1.05	
1L84	1.10	6BN6	1.20	12AU6	.65	
1LN5	1.10	6BQ6GT	1.27	12AV6	.84	
1N5GT	.95	6BQ7A	1.23	12AV6	.55	
1R4	.75	6BX7GT	1.25	12AV7	1.00	
1R5	.75	6BY5G	1.75	12AW6	.88	
1U4	.75	6BZ5	1.28	12AX4	.90	
1U5	.70	6C4	.56	12AX7	.80	
1V	1.03	6CB6	.50	6CG	.70	
1V2	.90	6CB7	.75	12AZ7	.92	
1X2B	.90	6C6G	1.80	12B4	.98	
1Z2	3.25	6CL6	2.10	12B6	.75	
3A4	.59	6CS6	2.10	12BD6	.75	
3B7	.39	6D6	.75	12BE6	.72	
3A4	.59	6E5	.68	12BH7	1.00	
3B8	.39	6F5GT	.68	12BZ7	1.10	
3A4	.59	6F6	.70	12SA6	.69	
3Q5GT	.90	6F6C	.90	12SF5	.70	
3S4	.75	6F8G	.85	12S7G	.80	
3V4	.75	6G6G	.85	12SH7	.55	
3V4	.75	6H6	.90	12SJ7	.85	
3V4	.75	6J4(RCA)	4.95	12SK7	.69	
3V4	.75	6K5	.55	12SL7G	.65	
3V4	.75	6L6	.60	12SQ6	.85	
3V4	.75	6M6	.75	12SQ7G	.63	
3V4	.75	6N6GT	.65	12SR7	.69	
3V4	.75	6P6	.88	12SX7GT	1.10	
3V4	.75	6Q6	.88	12Y7	.75	
3V4	.75	6R6	.88	12Z6GT	2.05	
3V4	.75	6S6	1.10	14F7	.75	
3V4	.75	6T6	1.10	198G6G	2.05	
3V4	.75	6U6	1.45	19T8	1.15	
3V4	.75	6V6	.80	258Q6GT	1.35	
3V4	.75	6W6	.70	25L6GT	.70	
3V4	.75	6X6	.95	25V6GT	.70	
3V4	.75	6Y6	.63	25Z5	.75	
3V4	.75	6Z6	.98	25Z6GT	.64	
3V4	.75	6A7	.69	26A6	1.75	
3V4	.75	6B7	.88	26A7GT	4.50	
3V4	.75	6C7GT	.80	26C6	1.25	
3V4	.75	6D7	.69	26E6	.70	
3V4	.75	6E7	.98	28D7	1.55	
3V4	.75	6F7	.65	35A5	.72	
3V4	.75	6G7	.69	35B5	.70	
3V4	.75	6H7GT	.65	35C5	.72	
3V4	.75	6J7GT	.79	35L6GT	.70	
3V4	.75	6K7GT	.63	35W4	.45	
3V4	.75	6L7	1.35	35Z3	.70	
3V4	.75	6M7	.99	35Z5GT	.50	
3V4	.75	6N7	1.05	50L6	.75	
3V4	.75	6P7A	1.30	50B5	.70	
3V4	.75	6Q7	.67	50C5	.72	
3V4	.75	6R7GT	.65	50L6GT	.70	
3V4	.75	6S7	.80	60	.66	
3V4	.75	6T7	.52	81	.75	
3V4	.75	6U7	1.00	84	624	1.15
3V4	.75	6V7	.75	117Z3	.65	
3V4	.75	6W7	.69	117Z6	.75	
3V4	.75	6X7	.75	1620	4.50	
3V4	.75	6Y7	.76	5642	4.50	
3V4	.75	6Z7	.76	5642	4.50	

SPECIAL-PURPOSE TUBES

Write for our complete listing of XMTG, Industrial, Special-Purpose and Crystal Diodes. We stock over 2,000 types at excellent prices.

Above is only a partial listing of our huge stock. Types not listed may be ordered at approx. the same savings. Many new special purpose types in stock.

AUTHORIZED DISTRIBUTORS

CBS-HYTRON EIMAC WESTINGHOUSE

ORIGINAL JOBBERS' BOXED TUBES IN STOCK—LATE DATES, at WHOLESAL PRICE LEVELS!

TWO-COLORED TUBE CARTONS, with new Safety Partitions. Prevents Tube Breakage. This Super-Gloss Red and Black Carton is the Most Distinctive Box Available Today! Minimum: 100 any one size. Quantity prices on request.

SIZE	Miniature	(6A5, 6AL5, etc.)	EACH
GT	(6SN7, 6W4, etc.)		\$0.125
LARGE GT	(1B3, 6XQGT, etc.)		0.15
LARGE G	(5U4C, 6BG6G, etc.)		0.2

Terms: 25% with order, balance C.O.D. All merchandise guaranteed. F.O.B., N.Y.C.

PHONE: REctor 2-2562

BARRY ELECTRONICS CORP.

136-B LIBERTY ST. N. Y. 6, N. Y.

70% to 90% OFF on TUBES INDIVIDUALLY FULL YEAR GUARANTEE! BOXED

SAME DAY SERVICE . . . OVER 300 TYPES IN STOCK AT ALL TIMES! Compare! Save!.. on RAD-TEL TUBES and PARTS!

No. 6 70° YOKE

Manufactured by Todd, Sickle and other leading mfrs. Very good value makes conversion profitable and simple. Get 'em while they're still around! List price—\$7.50



\$1.95
Lots of 5
\$1.80 ea.

No. 7
55° YOKE
99¢ Lots of 3
89¢ ea.

Granco "Star" UHF CONVERTER

Brand new! Latest model! Unit is highly engineered, receives all UHF channels. Coaxial tuned cavity elements complete with 6AP4 oscillator, 6CB6 I-F and crystal mixer. Shipped ready to install and operate. List Price \$29.95.



\$22.45
Deluxe model Five Star UHF Converter. Pre-selector for 1N82-6BQ7 diode and 6AP4 oscillator. List price \$39.95.
\$29.97

Philco TV BOOSTER

Completely self-contained, including 2 6J6 tubes . . . 1 for high channels and 1 for low channels and selenium rectifier. Plastic cabinet, in factory-sealed cartons, complete with instructions No. 125

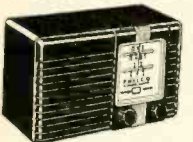

\$10.95 Lots of 3
9.95 ea.

STANDARD BOOSTER COMPLETE \$5.95

VARIABLE CONDENSERS

Manufactured by Philco, Radio Condensers, etc.

2 Gang AM and FM No. 9 Each Lots of 3
Contains 2 separate sections for AM and 2 for FM with padder condensers. With attached slug tuned high frequency coil whose plunger is geared to condenser shaft. Pulley type drive wheel.

89c **79c**

2 Gang AM 3 Gang FM No. 10
Equipped with drum pulley and padders.

89c **79c**

2 Gang Superhet No. 11
Complete with padders and drum pulley drive.

79c **69c**

3 Gang AM Superhet No. 12
Complete with padders and pulley type drive wheel.

89c **79c**

No. 96 Famous Standard Coil CASCODE TUNER



Famous standard tuner TV front end. Double the gain with a great reduction in noise. A MUST for fringe area replacement. Includes tubes 6BK7 or 6BQ7 and 6J6.

\$14.95 List price \$34.50

ANODE CAPS 19c ea. Lots of 10
18c ea.

No. 132 CATHODE RAY TUBE REJUVENATOR

Fits all makes of picture tubes. Completely automatic. Easy to install, no tools needed. For A.C. parallel circuits. Your Old Picture Tubes Are Still Useful. List price—\$5.95.

Lots of 10
1.09 **1.39**
Each each

All New Parts At Old Fashioned SAVINGS!

No. 82 HI-Watt RESISTOR KIT

Consisting of 5, 10, 15 and 20 Watt vitreous type resistors by Ward, I.R.C., etc. A top-flight buy!

ASSORTED KIT OF 20
Lots of 3 Kits
\$1.95 **\$1.85 ea.**

WEN SOLDERING GUN

3 seconds on 120 Volt AC readies it for any soldering requirement. 250 Watt size. Also cuts plastic tile (with special tip). Multi-useful! UL Approved. Built in spot light. 9.71 Each. List price—\$12.95
Lots of 3, \$8.84 Each

TIPS
Fernloy Long Life.....35c ea.
Standard Tip.....11c ea.
WEN POLISHER 10.46 ea. Lots of 9, 30 ea.

No. 47 CERAMICON KIT

1 kit of 50 assorted ceramic discs, biplaters, tubular condensers. All condensers popular sizes, used in T.V. and F.M. sets. A MUST kit. List price—\$10.00.

\$1.99
Lots of 5
\$1.89 ea.

No. 75 ARMY-NAVY HEAD SETS

Individually boxed. Very sensitive. Meets both Army and Navy specifications. List price—\$16.00.

\$2.95
Lots of 3
\$2.83 ea.
each per set

No. 46 HI-VOLTAGE R.F. COIL

4500 VOLTS RF TRANSFORMER
Ideal for T.V. and Oscilloscope power supplies, using 5" to 7" tubes. This buy is too BIG to be beaten! List price \$7.50.

79c Lots of 3
69c ea.

No. 44 10 inch SPEAKER

2.15 oz.
\$3.95 Lots of 5
\$3.60 ea.

No. 107 DOUBLE FLYBACK

TTR-172 up to 3.5kv output. RCA Type Horizontal deflection transformer, with two filament windings for voltage doubler operation. First time at this low price.
\$1.89 ea. Lots of 3
\$1.79 ea.

Type	Price	Type	Price	Type	Price	Type	Price
OA2	.74	6AU6	.46	7A5	.59	14A4	.69
OA4	.68	6AV5GT	.83	7A6	.69	14A5	.59
OB2	.81	6AV6	.40	7A7	.69	14A7	.63
OC3	.72	6AX4GT	.65	7A8	.68	14AF7	.59
OD3	.70	6B4	.54	7AD7	.79	14B6	.63
OZ4M	.55	6BA6	.49	7AF7	.53	14B8	.63
1A5	.49	6BA7	.57	7B4	.44	14C7	.79
1A7GT	.47	6BC5	.54	7B5	.45	14E6	.75
1AX2	.62	6BD5	.59	7B6	.69	14E7	.88
1B3GT	.73	6BD6	.45	7B7	.49	14F7	.65
1C5	.43	6BE6	.51	7C4	.59	14H7	.59
1E7	.29	6BF5	.41	7C5	.69	14J7	.30
1G6	.24	6BF6	.37	7C6	.59	14N7	.84
1H4	.30	6BG6G	1.25	7E5	.59	14R7	.79
1H5GT	.49	6BH6	.53	7E6	.30	14S7	.89
1L4	.46	6BJ6	.49	7E7	.59	14W7	.30
1LA4	.59	6BK5	.80	7F7	.79	14X7	.69
1LA6	.69	6BK7	.80	7G7	.89	14Y7	.62
1LC5	.59	6BL7GT	.83	7H7	.59	19BG6	1.39
1LC6	.79	6BN6	.59	7J7	.79	19T8	.69
1LD5	.59	6BQ6GT	.98	7K7	.69	19V8	.79
1LE3	.59	6BQ7	.90	7L7	.59	24A	.39
1LG5	.69	6BZ7	.90	7N7	.69	25AV5GT	.83
1LH4	.69	6C4	.40	7Q7	.66	25BQ6GT	.98
1LN5	.59	6C5	.39	7R7	.89	25L6GT	.51
1N5GT	.67	6C6	.58	7S7	.79	25W4GT	.59
1P5GT	.57	6CB6	.54	7V7	.89	25Z5	.66
1Q5GT	.58	6CD6	1.11	7X6	.54	25Z6	.49
1R5	.62	6CF6	.64	7X7	.70	26	.45
1S4	.59	6D6	.59	7Y4	.69	27	.39
1S5	.51	6E5	.48	7Z4	.59	32L7	.89
1T4	.58	6F5GT	.39	12A4	.60	35	.58
1U4	.57	6F6	.59	12A6	.54	35B5	.52
1U5	.50	6G6	.42	12A8GT	.61	35C5	.51
IV	.43	6H6GT	.41	12AL5	.37	35L6GT	.51
1X2A	.63	6J5GT	.43	12AQ5	.52	35W4	.47
2A3	.30	6J6	.52	12AT6	.41	35Y4	.54
2W3	.38	6J7	.43	12AT7	.72	35Z3	.59
2X2	.49	6K5	.47	12AU6	.46	35Z4	.47
3A4	.45	6K6GT	.45	12AU7	.60	35Z5GT	.47
3E5	.46	6K7	.44	12AV6	.39	36	.39
3LF4	.69	6L6	.64	12AV7	.73	41	.42
3Q4	.48	6L7M	.68	12AX4	.67	42	.42
3Q5GT	.49	6N7M	.63	12AX7	.63	43	.55
3S4	.58	6Q7	.45	12AY7	.99	45	.55
3V4	.58	6R7	.69	12AZ7	.59	45Z3	.44
5U4G	.55	6S4	.48	12B4	.60	45Z5	.49
5W4GT	.50	6S7M	.79	12BA6	.49	50A5	.55
5Y3GT	.37	6S8GT	.53	12BA7	.60	50B5	.52
5Z3	.45	6SA7GT	.55	12BD6	.45	50C5	.51
6A6	.51	6SD7GT	.41	12BE6	.51	50L6GT	.61
6A7	.69	6SF5GT	.46	12BF6	.39	50Y6	.49
6AB4	.44	6SG7GT	.41	12BH7	.63	50Y7	.50
6AC5	.69	6SH7GT	.49	12BY7	.65	55	.49
6AC7M	.86	6SJ7GT	.41	12BZ7	.65	56	.49
6AF4	.90	6SK7GT	.53	12C8M	.34	57	.58
6AG5	.56	6SL7GT	.48	12H6	.56	58	.60
6AG7M	.99	6SN7GT	.59	12SC7M	.63	70L7	.97
6AH4	.57	6SQ7GT	.46	12J5	.42	75	.49
6AH6	.73	6SR7GT	.45	12J7	.49	76	.44
6AJ5	.65	6SS7GT	.42	12K8	.59	77	.57
6AK5	.55	6T4	.99	12Q7	.59	78	.47
6AK6	.59	6T8	.80	12S8GT	.62	80	.43
6AL5	.42	6U5	.57	12SA7GT	.65	83V	.68
6AM8	.78	6U6	.59	12SF5	.50	84/6Z4	.46
6AQ5	.50	6U8	.78	12SG7	.51	85	.59
6AQ6	.37	6V6GT	.50	12SJ7M	.67	117L7	.99
6AQ7	.70	6W4GT	.47	12SK7GT	.63	117P7	.99
6AR5	.45	6W6GT	.57	12SL7GT	.57	117Z3	.37
6AS5	.50	6X4	.37	12SN7GT	.52	117Z6	.69
6AS6	.69	6X5GT	.37	12SQ7GT	.56	807	.99
6AT6	.41	6X8	.75	12SR7M	.49	866A	1.39
6AU4GT	.68	6Y6G	.48	12V6GT	.46	Hi-Po	
6AU5GT	.82	7A4	.47	12X4	.38	#567	1.39

RAD-TEL TUBE CO.

Dept. RE7

115 Coit St.,
Irvington 11, N. J.

"Integrity Is Our Chief Asset"

TERMS: A 25% deposit must accompany all orders—balance C.O.D. All shipments F.O.B. Irvington warehouse. **ORDERS UNDER \$10—\$1.00 HANDLING CHARGE.** Subject to prior sale.

PLEASE: Send full remittance . . . allow for postage and save C.O.D. charges! We refund all unused money!

Send For FREE Illustrated PARTS CATALOGUE

Phone: Essex 5-2947

Tubes in Bold Type Cover 90% of Demand

**SELENIUM RECTIFIERS**

We specialize in Rectifiers. Power supplies to specifications. Immediate delivery.

Curr. Conts.	Volts	18 1/4	36 28	54/40	130/100
1AMP	1.40	2.40	3.80	8.50	
2AMP	2.10	3.00	5.40	10.50	
4AMP	3.75	5.10	8.50	15.25	
6AMP	4.50	6.00	13.00	33.00	
10AMP	6.60	12.75	20.00	42.50	
12AMP	8.10	15.75	25.25	51.75	
20AMP	12.75	25.50	38.00	79.50	
24AMP	16.25	32.50	45.00	86.50	

Rectifier & Transformer

up to 14VDC at 12 Amps	5	19.98
up to 28VDC at 4 Amps	14	14.98
up to 28VDC at 12 Amps	28	29.98
up to 28VDC at 24 Amps	42	63.98
up to 28VDC at 50 Amps	127	127.00

WRITE FOR POWER RECTIFIER CATALOG

**HIGH CURRENT PWR SUPPLIES**

Variable 0-28VDC. Completely Built. Ready to Go. Full Wave Selenium Rectifier. Transformer. Voltage. Volt & Amp Meters. Switch. Terminals & Fuse. In Hwy. Dry Steel Cabinet. Standard 115V 60 Cy Input. 220V to Order. Write!

Stock Number	Rating	With Meters
T28V5A	0-28VDC at 5 Amp	\$47.75
T28V12A	0-28VDC at 12 Amp	\$49.00
T28V24A	0-28VDC at 24 Amp	129.50
T28V50A	0-28VDC at 50 Amp	239.50

AMPs rated 6/12VDC continuous, metered

RECTIFIER XFMRs

4 Amp	0.7 Hy	6 Ohm	\$7.95
12 Amp	.01 Hy	1 Ohm	14.95
24 Amp	.004 Hy	.025 Ohm	29.95

RECTIFIER CHOKES

4 Amp .07 Hy	6 Ohm	\$7.95
12 Amp .01 Hy	1 Ohm	14.95
24 Amp .004 Hy	.025 Ohm	29.95

TUBES

0A2	.88	6AQ5	.52	6V6G	.60	6V6G	.88
0A3	1.04	6AQ6	.81	6X4	6.66	7AB7	.68
0B2	1.31	6AR5GT	1.29	6J6	.58	7F7	.82
0B3/VR90	.96	6AR6	3.27	6J6	.58	7F7	.82
0C3/VR105	.92	6AR5	2.79	6J7	.72	7F8	1.24
0D3/VR150	.80	6AR6	4.29	6K6	.58	7N7	.92
1B3/8016	.80	6AS7G	3.48	6K7	.58	7N7	.92
1L4	.48	6AT6	.66	6K4A	3.68	7V7	1.06
1L6	1.16	6L6GT	1.10	6K8GT	1.48	7Y4	.48
1LD5	.98	6AU6	.56	6L6	1.48	12A6	.48
1LN5	.78	6AV5GT	.98	6L6G	1.08	12AT6T	1.45
1P5	1.15	6AV6	.42	6L6CA	1.08	12B7	.54
1T4	.78	6AX4 6U4	.74	6L6GAY	1.98	12A7G	.54
1R4	1.29	6B4C	1.18	6SA7GT	.60	12AT7	.89
1R5	.85	6B5	1.22	6SA7	.90	12AU6	.69
1R5	.52	6B7	1.09	6S7G	.90	12AU7	.69
2A5	.54	6BC5	.63	6S7	.73	12AV6	.52
2A4G	1.18	6BC7	1.23	6S7G	.64	12AV7	.52
2X3	1.20	6BD6	1.23	6S7GT	.64	12AV6	1.18
SR4G	1.20	6BE5	.54	6S7J	.56	12AX7	.98
SR4GYW	1.75	6BF5	.98	6SK7GT	.56	12AX7	1.69
ST4	1.64	6BQ6	1.18	6SM7	.56	12AX7	.98
5U4G	.55	6BM6	.63	6SN7GT	.68	12B7	.94
5X4G	.79	6B8	.69	6SQ7GT	.62	12BD6	.59
6AC7	.75	6BK7	1.22	6S8	.62	12BE6	.52
6AG5	.71	6BL7GT	1.19	6S57	.88	12BF6	.85
6AG7	1.14	6AG7	2.69	6T8	.96	12BH7	1.29
6AN6	1.26	6BQ7	1.65	6L4	.74	12C6	.62
6AJ5	1.40	6C4	.52	6U8	.99	12H6	.64
6AK5	.87	6C4	.52	6V6	1.39	12J5	.52
6AK6	.92	6C6	.68	6V6GT	1.48	12P6	.58
6AL5	.48	6CB6	.59	6W4GT	.52	12Q7GT	.55
6AL7GT	.98	6D4	2.70	6X4	.49	12SA7GT	.68
6AN5	3.27	6F6GT	.79	6X5	.54	12SC7	1.08

106 WATT SEC PHOTOFLASH KIT-AC

Includes transf. condensers two 5.25MFD 450V Total 103W Sec'd Resistors, capacitor, rectifier, flash tube in indicating flash gun, guide #40 on Kodachrome. Special \$39.98

BATTERY 106 WATT /SCDS PHOTOFLASH KIT

Same specs. only 4 batteries @ 90V 450V total. 2000 to 3000 flashes. \$42.98

"TAB" PHOTOFLASH LAMPS

No.	Replaces	Watts	W-Sec.	Max. Each
TLW	FA104/USW	150	55.98	
FH1	FMLO 5804X	100	10.98	
23ST	GE FT 210	200	9.98	
THVA	SYLV 4330	200	9.98	
TLW	GE FT 118	150	5.98	
Y4X4	X400	200	10.98	
TLX	FA100/DX	150	9.00	
353GT	FT 105	200	14.00	
TR11D	FT 105	150	4.29	

TRIGGER COIL FOR GE 86G4 1.48

WRITE FOR "TAB" FLASH TUBE DATA BOOK

866A KIT and XFORMER

(2) 866A Tubes & Sockets. Transformer Rated. PRL115V 60CY. Sec 2.5VCT/10A HI-Volt Insulation \$4.98

"LENK" 180 WATT PERFECT BALANCE SOLDERING GUN

Another soldering gun offers all these features at any price. 115V/AC 180 Watt. Lightweight. 28 ozs., melts solder 31/2 seconds, swivel duty transformer. Heavy duty.

FAMOUS MAKE GUNS

TAS-4 soldering gun 135W	7.99
TAS-5 soldering gun 210W	9.99
TAD-4 dual heat 100-150W	9.65
TAD-5 dual heat 200-275W	10.50
TA-3 soldering iron 115V/60Watt	10.50
TA-250 soldering gun 2 tips 115V/AC 250W focus light, built for comfort 10.29	

"TAB" THAT'S A BUY**BATTERY CHARGER RECTIFIER**

13.0-13V (CT) 100 Amp. fan cooled. Replace your old inefficient sulfide rectifier with new selenium type. For QTY PRICE.

CONDENSER SPECIAL

2 MFD 1000 VDC 25¢ 330 VAC "CD" MFGR each Lot.

VARIABLE DC POWER SUPPLY

Full Wave rectification, 6000MFD filter Condensers fused, 6.3V 12.6V 115V/60CY Model 2DFC SPDT 15A/125V AN3022-2B As above except 4 amp. Model 4DFC \$20.98

TOGGLE SWITCHES

SPDT 15A/125V Center Off	AN3022-1B	\$2.50
SPST 5A/125V used Ltr 4/51		
SPDT 15A/125V Center Off		
10mm. .79¢; 3/2; 20/510		
SPDT 15A/125V AN3022-2B		
59¢; 3/5.125; 30/510.00		
DPST 20A/125V AN3027-2B		
69¢; 5/52.50; 25/510.00		
DPST 5A/125V B&K CSD. 49¢; 3/51.20		
3PDT 22A/125V C Hammer	1.49; 2/1.98	
4PDT 10A/125V	\$1.98; 3/55; 20/30	

OIL CONDENSER SPECIAL

2MFD 600VDC

Aerovox Type P09 Steatite Insulators. Adjustable Mounting. Case 27 dia. x 2 1/2" high. BRAND NEW 69¢; 3 for \$1.50

TV & COAX CABLE

300 Ohm Twinex. Heavy duty 65 mil copper TV lead in. \$1.39 per ft. 2¢; 100 ft. \$139

TELEVISION ANTENNA

VEE CONICAL Broad response, all channel, power-impedance matched, 20' FOLDED DIPOLE HI & low antennas, all channel, sturdy construction \$4.95

YOU PICK THEM 59¢ WHILE THEY LAST

Small selection of 10 at 59¢ each or 25 at 75¢ quantity at 1.00 each

ELECTROLYTIC CONDENSER

25 20MFD/450VDC	69¢; 3 for \$1.95
3X 20MFD/450VDC	98¢; 3 for 2.50
3X 20MFD/400VDC	79¢; 2 for 1.29
25MFD/450VDC	69¢; 3 for 1.95
20MFD/450V/25V/35V	3 for 1.95
50 m/350Vdc Pvc	5 for 1.00
30-15-10 m/250Vdc	5 for 1.20
18MFD/450V	55¢; 3 for 1.20
Dual 8MFD/450V	75¢; 3 for 1.50
Dual 16MFD/450V	85¢; 3 for 2.00

WAREHOUSE CLEARANCE

CRYSTALS FT243 Holder 4190, 4780, 5030, 5235, 5485, 5880, 6030, 6310, 6510, 6710, 6910, 7110, 7310, 7510, 7710, 7910, 8110, 8310, 8510, 8710, 8910, 9110, 9310, 9510, 9710, 9910

125F7GT

125F7GT	.84	CK536AX	.99
125G7	.80	CK538DX	.99
125H7	.82	CK539DX	2.29
125J7GT	.54	CK543DX	.99
125K7	.66	CK544DX	.99
125L7GT	.62	CK545DX	.99
125M7GT	.68	CK571AX	2.49
125N7GT	.54	CK1005	1.68
125P7GT	.58	CK5672	1.28
125Q7GT	.54	CK5678	1.28
125R7GT	.58	CK5702	2.90
125S7GT	.58	CK5703	1.29
125T7GT	.58	CK5704	1.29
125U7GT	.58	CK5705	1.29
125V7GT	.58	CK5706	1.29
125W7GT	.58	CK5707	1.29
125X7GT	.58	CK5708	1.29
125Y7GT	.58	CK5709	1.29
125Z7GT	.58	CK5710	1.29

OIL CONDENSERS

NEW WAREHOUSE LIST

0.0025MFD/25KV \$4.00; 2 for \$7.00

0.016MFD/15KV \$7.00; 2 for \$12.00

2X 1MFD/2000V \$1.39; 2 for \$2.00

1MFD/600V .25¢; 6 for \$1.00

1MFD/1000V .85¢; 3 for \$2.00

1MFD/500V .25¢; 6 for \$1.00

1MFD/600V .39¢; 3 for \$1.00

1MFD/1000V .39¢; 3 for \$1.00

2MFD/600V .5798; 2 for \$1.40

4MFD/500V \$1.95; 2 for \$3.50

16MFD/60VAC/1800VDC \$1.50; 3 for \$2.10

10MFD/600V(2.5-2.5-5MFD) oil 12 for \$18

SPEEDWAY ELECTRIC DRILL 1/4" MODEL 200J

Hi-Torque powerful UL approved 2400 RPM AC/DC motor. Jacobs geared chuck and key. Self-aligning - oilless anti-brush bearings. Light weight and easy to handle.

CHROME VANADIUM SPEED DRILLS

29 Perc Set 1/16" to 1/2" by 64ths \$7.98

NEW RHEOSTAT LIST

20 ohm 30W Model P.98; 10 for 14.00

TRANSFORMERS

All 115 V 60 Cyc Input TV & CR Power Xmas Trees

230 TO 115V AUTOFORMERS

For 220-250V 30-60Cy Input To 110-125V

FILTER CHOKES

6HY/175MA \$1.49; 2/2.49

TRANSFORMER SPECIAL 6.3 VOLT 3/4 AMP

CONTINUOUS DTY, 115VAC Input

FILAMENT TRANS.

2.5VCT/10A 12.8KVINS \$5.50; 3 for \$14

PRECISION RESISTORS FOUR MILLION IN STOCK

All 1% Accuracy Gtd

SPECIAL SALE TEST EQUIPMENT

NEW & LIKE NEW (LN) ALL TESTED-MONEY BACK GUARANTEE

CIRCUIT BREAKERS

Heinman Magn. Brks. Amps: 220, 3, 7, 9, 12, 15, 20, 30, 35, 40, 80, 180

"TAB" SPECIALS

NUMERON color TV-Clock & Lite \$7.98

CIRCUIT BREAKERS

Heinman Magn. Brks. Amps: 220, 3, 7, 9, 12, 15, 20, 30, 35, 40, 80, 180

MONEY BACK GUARANTEE

Dep. Tubes Gtd. via R-Exp. only. Prices subject to Change Without Notice. Phone Recto 2-6245.

CABLE: "TABPARTS"

**NOW—Better
choice than ever!
—in CRYSTAL
MICROPHONES**

**NEW
MODEL 924**

Unique crystal Lavalier for chest or hand use. Supplied with neck cord, support clips and 18' cable. Output —60 db. Response 70-8,000 cps. For home recording, paging, PA and amateur radio. Pressure cast case in lustrous satin chrome finish. Wire-mesh head acoustically treated for wind and moisture protection. Hi-Z. Size 3-5/32" x 1-7/32".
Net wt. 8 oz. List Price \$18.00



Model 915 CENTURY

Most popular microphone ever produced! Stands by itself. Fits in hand or on stand. Smooth response 60-7000 cps. Output —50 db. AC-DC insulated. Moisture-sealed crystal. Satin Chromium finish. Hi-Z.
Model 915. List Price \$11.25
Model 915-S. With switch. List \$13.00

NEW "926"



**E-V QUALITY, AT LOW COST
—IN NEW SLIM DESIGN**

The "926" crystal microphone combines handsome new styling with E-V quality features! Designed for public address, tape recording and communications. Frequency response is smooth, peak-free 70-8000 cps. Output level—60 db. Omnidirectional. Hi-Z. Moisture-sealed crystal. 5/8"-27 thread stand coupler. Die cast case, finished in Satin Chromium. Size 1 1/4" x 6 1/2" including swivel mount. 18 ft. cable. Net wt. 11 oz.

Model 926. List Price \$24.50

With two brand new models, E-V again sets the pace in crystal microphones! This 1954 line makes selection easier, more complete...assures top performance...provides maximum value. Each has the advantage of E-V research-engineering, precision manufacturing and quality control. Each is styled to suit individual taste and purpose. Each offers smooth, clear reproduction of voice and music—and high output—for public address and paging, for amateur communications, for improved home tape recording. Write for full information.

Electro-Voice

ELECTRO-VOICE, INC. • BUCHANAN, MICH.

Export: 13 E. 40th St., N.Y. 16, U.S.A. Cables: Arlab

Licensed under Patents of the Brush Development Co. E-V Pat. Pend.

Model 920 SPHEREX

All-direction pick-up for round-table conferences, home recording and public address. Response 60-7000 cps. Output level —50 db. Omnidirectional. Acoustic filter protects against wind and breath blasts. Moisture-sealed crystal. Hi-Z. Satin Chromium finish.

Model 920. List \$22.50



Model 911 MERCURY

Smartly designed for general-purpose use. Response 50-8000 cps. Output —50 db. Omnidirectional. Metal Seal crystal. Hi-Z. Tilttable head. "On-Off" switch. Built-in cable connector. 5/8"-27 thread. Satin Chromium finish. 6 ft. and 18 ft. cable.

Model 911-8. List \$25.50
Model 911-20. List \$27.50



Model 950 CARDAX

World's favorite high level crystal cardioid* with dual frequency response for high fidelity sound pick-up or for extra crispness of speech. Reduces feedback and background noise. Metal Seal Crystal. Hi-Z. "On-Off" switch. 5/8"-27 thread. Tilttable head. Satin Chromium finish. 18 ft. cable.

Model 950. List \$42.50



* E-V Pat. 2,627,558

BRUNO MATAS 3-56
20 EVERETT ST
LAWRENCE MASS

for **COLOR TV**

Now at no extra cost to you
the famous **RCA INSTITUTES**

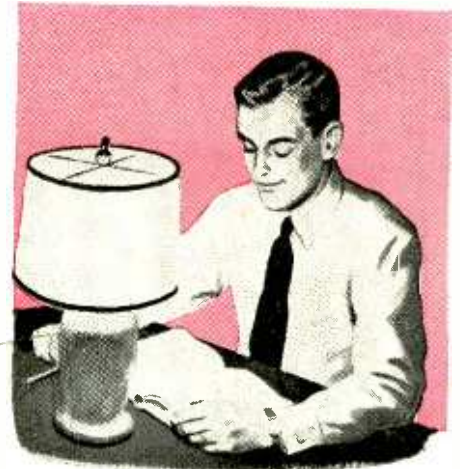

HOME STUDY COURSE IN COLOR TV with your purchase of RCA Tubes

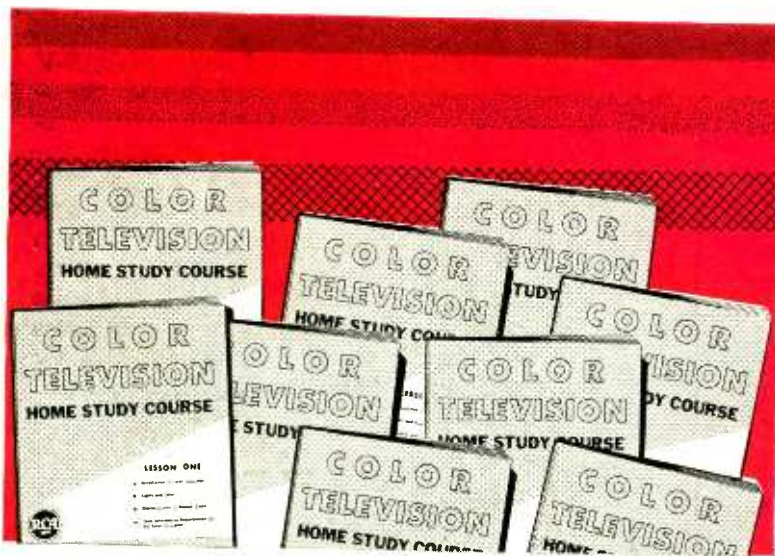

LOOK WHAT YOU GET...

GROUP I—COLOR TV THEORY

1. Introduction to Color Television
2. Principles of Two-Phase Modulation and Colorimetry
3. Principles of Color TV Receivers

GROUP II—COLOR TV RECEIVERS

4. Color Kinescopes
5. The Color Television System
6. Color TV Receiver Circuits

GROUP III—COLOR TV SERVICING

7. Set-up and Adjustment of Color TV Receivers
8. Servicing and Alignment of Color TV Receivers
9. Test Equipment for Color TV Servicing

Here is an outstanding offer which can put your service business out front in your neighborhood. Here is an opportunity to learn more about color TV . . . quickly . . . thoroughly from the famous RCA Institutes. When you buy RCA Tubes, you can earn a complete, 9-step Home Study Course on Color TV at no extra cost. This is your chance to improve your outlook for COLOR TV profits *now* before this big business gets into full swing.

Remember—the RCA Institutes Home Study

Course in Color Television is an *advanced course*, written expressly for experienced television technicians who want to be prepared for the specialized business of Color TV servicing. Remember also that RCA pioneered and developed compatible Color Television.

Act today on this progressive offer. Ask your RCA Distributor Salesman for complete details as to how you can earn the RCA Institutes Color TV Home Study Course **FREE** with your purchases of RCA Tubes.

ACT NOW!— Offer expires November 15, 1954.



RADIO CORPORATION of AMERICA
ELECTRON TUBES

HARRISON, N. J.

ADV Plans, LLC

Copyright Notice:

The entire contents of this CD/DVD are copyright 2014 by ADV Plans, LLC. All Rights Reserved.

Reproduction or distribution of this disk, either free or for a fee is strictly prohibited. We actively monitor and remove listings on eBay thru Vero.

You are free to copy or use individual images in your own projects, magazines, brochures or other school projects.

Only the sellers listed here are authorized distributors of this collection:
www.theclassicarchives.com/authorizedsuppliers

Please view our other products at
www.theclassicarchives.com,
or our ebay stores:

[TheClassicArchives](#)
[ADVPlans](#)
[SuperShedPlans](#)

